



Advanced Interface Manual

Contents

Copyright Notice	10
About This Manual	11
Melco OS V11 Version Changes	12
v11.09.XXX	12
v11.08.XXX	13
v11.07.XXX	14
v11.06.XXX	15
v11.05.XXX	15
v11.04.XXX	15
v.11.03.XXX	15
v11.02.XXX	16
v11.01.XXX	17
Hazards of Operation	18
Dangers de Service	19
Safety Warnings	20
Avertissements de sécurité	24
Safe Operating Principles	28
Specifications	29
Operator's Kit Contents	31
Unpacking the Machine	32
Setting up the Machine	32
Install the Machine User Interface and X-Beam End Caps	34
Machine Overview	35
Cart Assembly	36
Software Activation & Deactivation	38
Lite	38
Product Activation	38
Product Deactivation	38
.Machine Connections	39
Do Not Share Networks	39
Connecting the Power Cables	39
Connecting the Network Cable (Single Machine)	40
Connecting the Network Cables (Multiple Machines)	41
Selecting The Connection	42

Powering Up the Machine	43
Initial Power Up Sequence	43
Upper Threading	44
Threading the Machine for the First Time	44
Quick Thread Change	46
Upper Thread Path	47
Bobbin Threading and Tensioning	51
Removing the Bobbin Case	51
Cleaning the Bobbin Case	51
Inserting a New Bobbin in the Bobbin Case & Checking the Tension	52
Bobbin Case Tension Gauge	52
Inserting the Bobbin Case	55
Initial Maintenance	56
Melco OS Screen Overview	57
Screen Overview	57
Loading a Design	61
Load Design	61
Load Design Wizard	62
Setting the Color Sequence	64
To enter a new color sequence:	64
To change a color in the existing color sequence:	65
To add a color to the existing color sequence:	65
To remove a color from the existing color sequence:	65
Additional Settings	65
Selecting a Hoop in the Software	66
Choosing the Appropriate Hoop Size	66
Customize Hoop List	66
Inches or Centimeters	67
Hoop Limits	67
Centering the Hoop	68
Setting the Sew Speed	69
How Fast Should I Sew?	69
Sew Speed Change from the Machine Keypad	69
Setting Sew Speed in Melco OS	70
Symptoms from Sewing too Fast	70
Acti-Feed	71
Material Thickness	71
Standard Acti-Feed	71
Auto Acti-Feed	72

Auto Acti-Feed Limits	73
Autofeed Lower Limit (Minimum)	73
Autofeed Lower Limit Suggestions	73
Autofeed Upper Limit (Maximum)	74
Appropriate Material Thickness Settings	75
Design Orientation or Rotation	76
When Should I Rotate My Design?	76
Choosing the Right Hoop	77
Choosing the Appropriate Hoop Shape	77
Choosing the Appropriate Hoop Size	77
Plastic or Wood?	77
Specialty Hoops	77
Hooping	78
Adjusting the Hoop Tension	78
Hooping the Garment or Fabric	79
Hooping Tips	81
Attaching or Moving the Hoop Support Arms	82
Attaching the Hoop Support Arms	82
Removing the Hoop Support Arms	84
Adjusting the Spring Clips	84
Loading a Hoop onto the Machine	85
Adjusting the Presser Foot	86
Keypad Operations	88
One Touch Controls	88
Key Combinations	89
LED Indicator	91
Sewing Your Design	92
After the Design is Sewn	92
Powering Down the Machine	93
Power Down Sequence	93
Needle Types and Replacements	94
Replacing a Needle	94
Choosing a Needle	95
Needle Points	96
Needle Coatings	96

Backings & Toppings	97
Backings	97
Backing Weights	99
Toppings	99
Thread Types	100
Thread Types	100
Thread Weight (Thickness)	101
Sewing Caps	102
Installing & Removing the Wide Angle Driver	103
Red Wide Angle Driver Installation	103
Red Wide Angle Driver Removal	106
Red Wide Angle Driver Cap Support Wings (Option)	107
Installation and Adjustment of the Cap Support Wing Assembly (Option)	107
Removal of the Cap Support Wing Assembly (Option)	109
Adjusting the Red Wide Angle Driver	111
Testing for Appropriate Adjustment	111
Adjustment Procedure	112
Selecting Hoops for the Wide Angle Driver	114
Hooping a Cap on the Conventional Cap Frame	115
Prepare the Cap	115
Hooping the Cap	115
Hooping a Cap on the Wide Angle Cap Frame	118
Prepare the Cap	118
Loading/Removing a Hoop with the Wide Angle Driver	125
Loading a Hoop	125
Removing a Hoop	126
Digitizing for Caps	127
Design Size for Caps	127
Sew Order for Cap Designs	128
Sew Settings for Caps	129
Adjusting the Presser Foot for Caps	130
Centering a Design on a Cap	131
Wide Angle Driver Maintenance	133
Wide Angle Driver Maintenance	133

Melco OS Menu Items	134
File Menu	134
View Menu	136
Commands Menu	139
Tools Menu	141
Tools Menu > Options	143
Preferences Tab	143
Measurement Units Tab	143
Barcode Options Tab	143
Notifications Tab	144
Ethernet Tab	144
Tools Menu > Settings	145
Machine Tab	145
Settings Tab	147
Move Tab	150
Color Sequence Tab	151
Color Groups	155
Settings By Color Tab	156
Thread Feed Tab	158
Timers Tab	159
Tools Menu > Maintenance	160
Information Tab	160
Head Timing Tab	161
Head Timing Keypad Functions	162
Steppers Tab	164
Calibration Tab	167
Sensors Tab	168
Keypad Tab	170
Design Filter	171
Hoop Manager (Hoop Setup)	173
Predefined Hoops	173
User-Defined Hoops	175
Additional Settings	177
Custom Hoop Shape	178
Custom Sew Field Shape	180
Set Machine Name & S/N	181
Tools Menu > Accelerator Editor	183
To setup a shortcut:	183
To remove a shortcut:	183
To restore system defaults:	183
Tools Menu > Security	184

Toolbars	185
Standard Toolbar	185
Machines Operations Toolbar	186
View Toolbar	187
Machine Bar	188
Machine List	189
Machine Views	190
Status Tab	190
Advanced Status Tab	191
Design Queue	192
Master Queue (Flex+ ONLY)	194
Setting the Color Sequence Using Active Colors	196
Manually Assigning Needles	196
Automatically Assigning Needles	196
Setting the Color Sequence with Active Colors	196
Additional Information on Color Sequence	197
Color Properties	197
Sewing An Appliqué	199
Anatomy Of An Appliqué Design	199
Setting the Color Sequence for an Appliqué Design	201
Sewing the Appliqué	201
Using a Boring Tool	202
Laser Alignment (Design Registration)	203
Scaling Designs with Laser Registration	205
Setting Up the Design in DesignShop	205
Using Barcodes with Melco OS	209
Enable Barcodes in the Software	209
Creating the Barcode	209
The Barcode Reader	209
Large Table Top Attachment (Option)	210
Installing the Large Table Top Attachment	210
Removing the Large Table Top Attachment	211
Thread Feeder Home Adjustment Procedure	212
Machine Maintenance	213
Cleaning	213

Lubrication & Maintenance Schedule	215
Maintenance Schedule	215
200,000 Stitch Maintenance	216
2,000,000 Stitch Maintenance	218
10,000,000 Stitch Maintenance	220
30,000,000 Stitch Maintenance	228
Thread Feed Roller Maintenance	234
Thread Break Troubleshooting	239
Diagnosing a Thread Break	239
Thread Break Diagnostic Table	240
Thread Breaks From Machine Issues	243
Troubleshooting the Upper Thread Path	243
Troubleshooting the Bobbin Thread	245
Troubleshooting Designs	247
Troubleshooting Tie Stitches	249
Troubleshooting Corners	252
Stitches Too Small	254
Troubleshooting Density	260
Troubleshooting the Needle	262
Troubleshooting the Presser Foot	263
Troubleshooting Scaled Designs	264
Troubleshooting Application Thread Breaks	265
Embroidering Abrasive or Coated Materials	265
Is the Needle Size Appropriate for the Design?	265
Is the Backing Appropriate for the Material?	265
Is the Design Appropriate for the Material?	266
Are You Using Adhesives?	266
Is the Garment Hooped Properly?	266
Are You Using Specialty Threads?	266
Troubleshooting Machine Caused Thread Breaks	267
Cleaning Under the Needle Plate	267
Center the Needle Plate	268
Pinch Rollers Need Maintenance	269
Rotary Hook Support Adjustment	271
Adjusting the Rotary Hook Support	273
Resetting the Machine	274
Deleting the Jobs & Machines Folders	274
Power Up the Machine With Force Download On	274

Additional Troubleshooting	275
Miss-Starts	275
Skipped Stitches	275
Loose/Looping Stitches	276
Needle Breaks	276
Registration Issues	276
Test Design Analysis	277
Software Messages	279

Copyright Notice

© Copyright Melco, 2018

ALL RIGHTS RESERVED. No part of this publication may be reproduced, stored in a retrieval system, or transmitted in any form or by any means (electronic, mechanical, photocopying, recording or otherwise) without prior written approval from the author. The author reserves the right to revise this publication and to make changes in it at any time without obligation of the author to notify any person or organization of such revisions or changes.

All precautions have been taken to avoid errors or misrepresentations of facts, equipment, or products. However, the manufacturer does not assume any liability to any party for loss or damage caused by errors or omissions.

The machine technology is protected by - but not limited to - the following patents:

- Pat. US 6,445,970 B1
- Pat. US 6,823,807
- Pat. CH 693569 A5
- Pat. US 6,736,077 B2
- Pat. US 6,732,668 B2
- Pat. US 6,871,605
- Pat. US 6,983,192 B2
- Pat. US 7,308,333 B2
- Pat. US 7,513,202
- Pat. US 8,851,001 B2
- Pat. US 9,702,070
- Other patents pending

About This Manual

This manual contains instructions on repairs and adjustments to the embroidery machine, in addition to other technical information.

If you do not fully understand any information in this manual, you are advised to contact your local authorized technical support provider for assistance.

Melco OS V11 Version Changes

v11.09.XXX

- “Optimized Locks” has been moved from design filters and is now located under Tools>Settings>Machine Tab. It is now called “Enable Tie In / Tie Off”.
- Improvements for machines with serial numbers of 403291 (or newly replaced boards) and above include:
 - Tie stitches added through “Enable Tie In / Tie Off” now occur in the firmware. This will not show in OS, but will be present in the sew-out. For previous machines, these ties will occur as they did in previous versions of software.
- A one second delay has been added to the center key on the keypad when pressing it alone to focus the software on the machine. This was added to prevent machines switching during design loading with multiple operators.
- Hoop selection via barcode has been fixed.
- Portuguese translations have been repaired.
- Security has been updated, and it now only shows the license for the product that is running.
- Thread feed motor tuning has been altered to reduce operating temperature. This will change the sound of the thread feed when the machine is running.
- Values for variable pull compensation (Custom 1) and minimum width have been altered.
- Minor bug fixes and performance improvements.

v11.08.XXX

- Addition of the following hoops
 - Mighty Hoop 6" x 4" / 15.2cm x 10.2cm
 - Mighty Hoop 3" x 9" / 7.6cm x 22.9cm
 - Melco Fast Clamp
- Adjusted Dream Frame hoop limits
- Updated Gunold thread charts.
- Resolved multiple maintenance UI issues
- Keypad commands entered while in load design screen will no longer lock keypad after exiting
- Color sequence improvements - Color blocks starting with trims will not adversely affect the sequence
- Improvements for machines with serial numbers of 403291 and above include:
 - Puff settings will remain after a trim
 - Stitch limit increased to 600,000
 - Start, tie, and trim improvements
 - Registration is retained after a manual trim
 - Needle centering at homing has been changed
- Minor bug fixes and performance improvements

v11.07.XXX

- Added support for EMT16 PLUS.
- Added support for Virtual Security Keys
- Machine list bar is now locked. If closed, it will reappear when the software is closed and launched again.
- Actifeed will now accept a value of up to 80. Actifeed is also now prevented from rising too high. Auto actifeed will feed as much as 127 points if no maximum is specified.
- “Machine Restarting” text now shows a more informative “Syncing Files and Updating Machine” as well as “This Process May Take Up To Five Minutes”.
- Maintenance Improvements
 - In the 30,000,000 stitch procedure, steps 4-13 through 4-19 have been altered to move the machine to a better position for tightening screws.
 - Thread Feed Roller count now resets when maintenance is performed.
 - In the 2,000,000 stitch procedure, the machine will not move to needle 1 between steps 4 and 5.
- Moving forward, updates will no longer overwrite colors assigned to the thread tree.
- Trimming improvements for rotary trimmers in earlier serial numbers.
- Inching count has been corrected and is now always respected.
- Statistical reports now work for all machines. For installation instructions, please see <https://melco.zendesk.com/hc/en-us/articles/206315625-Enabling-Statistical-Reports-in-Melco-OS>
- Machines now display the last state if OS is restarted.
- Color change homing at start up has been improved. Needle case calibration may be required. Instructions for calibration are located in the technical manual.
- Z-Axis issue of occasionally not finding home has been resolved.
- PF Adjust has been added.
- Improvements for machines with serial numbers of 403291 and above include:
 - Smoother movement in X and Y
 - Increased strength in Z
 - Improved initial start-up procedure
 - Tuning improvements in stitch dynamics
 - Tuning improvements in thread trimming
- Return to Origin addressed
- Hoop limit detection verification upon launch

v11.06.XXX

- UI changes
- Minor bug fixes and performance improvements.

v11.05.XXX

- Packaging changes for the machine.
- Mighty Hoops - The hoop limits have been adjusted to allow for sewing closer to the edges and corners. Additional hoops have been added.
- Strap Clamps - Strap clamps have been added to the hoops.
- Acti-feed and trim improvements.
- Updated security support.
- Enhanced hardware support.
- Minor bug fixes and performance improvements.

v11.04.XXX

- Check For Updates - If updates are available, the software will automatically display an update notification. Internet connection is required for this feature.
 - Update process improvements.
- Bypass for "Trim Required" - Should you encounter a "Trim Required" message, it may be bypassed using the keypad command of adjustment key + hoop key.
- Adjustment of thread break sensor readings to reduce false upper and lower thread breaks.
- Bobbin case recommendation change - change in construction and pigtail location/angle.
- Single Stitch Filtering – A single stitch flanked by jumped stitches will now be filtered out to avoid needle breaks.
- Stitch Type - Stitch types for Fancy stitch (Burmilana), 2mm Puff, and 3mm Puff have been added to the Color Sequence window.
- Addition of the following Mighty hoops
 - 7.25"x7.25"/18.4cmx18.4cm
- Windows 10 Compatible

v.11.03.XXX

- Check For Updates - Now the update link provides the option to download and view "What's New" in the new version before choosing to update.
- Updates will also prompt user to restart machine(s).
- Manual Update - LED status has been added to the manual.

v11.02.XXX








- Optimization to thread break sensor calibrations (Advanced Interface)
- Ability to update Melco OS V11 via check for updates (need Internet connectivity)
- Addition of the following Mighty hoops
 - 8.25"x6.25"/21cmx15.9cm
 - 4.25"x4.25"/10.8x10.8cm
 - 5.5"x5.5"/13.5x13.5cm
 - 10"x10"/25x25cm
 - 4.25"x13"/10.8x33cm
 - 13"x8"/33x20cm
 - 13"x11"/33x28cm
 - 15"x12"/ 38x30cm
 - 16"x13"/40.6cmx33cm
- Addition of the following HoopTech Clamps/Frames
 - Small Shoe Clamp
 - Large Shoe Clamp
 - Red Cap Side Clamp
 - Koozie Clamp
 - Hat Back Clamp
 - Dream Frame
- Ability to send a design from DesignShop to Melco OS
- Fixed issue with design displaying the previous design on main screen and simplified view
- Increase stitch limit to 205,000 stitches
- Melco OS tool bars will snap to one line if screen is maximized
- Added Melco XT and XTS to hoop machine type
- Added Russian language support to the simplified view
- Copyright date is now 1992-2015
- During installation the communications drivers are signed by Melco

v11.01.XXX

- Simplified user view along with tradition Melco OS view. This is optimized for a touch screen Windows device.
- Two click installation of Melco OS
- Hoop database is now located a shared location with DesignShop V10
- Ability to load .emb file format (up to 1.8)
- Ability to load .psf (Pulse) file format
- Ability to load .art file format (up to .art70)
- Additional .jef file support
- Updated stitch based maintenance (this is done while in the advanced interface in Melco OS V11)
- Time based maintenance (this is done while in the simplified user view in Melco OS V11)
- Operator's manual has been updated and now is in .pdf format.
- Updated Madeira Poly Neon thread chart
- Updated Isacord 40 thread chart
- SE level supports one machine only
- Improved icon preview generation
- Fully compatible with Windows 7, Windows 8, and Windows 8.1 without compatibility mode enabled
- Simplified hoop selection by hoop type categories. For example: square hoops, round hoops, etc. (Simplified user view in MOS V11)
- Simplified acti-feed selection by just selecting a product type. For example: if the user is sewing a polo shirt they can just select the t-shirt in product type in the simplified user view in MOS V11.
- Simplified position screen. User can easily do things like rotate a design 180 degrees by just a single click (Simplified user view in MOS V11)
- Simplified load design window (Simplified user view in MOS V11)
- Simplified color sequence window. This includes a puff and fancy stitch function that can be just dragged onto the color that you want it applied to. This also includes a color sequence repeat function. This can be applied when doing applications like step and repeat (Simplified user view in MOS V11)
- Thread break sensor calibration tool. This allows you to fine tune the thread break sensor so that false thread breaks can be eliminated (Advanced Interface view in MOS V11)
- New colorized status bar. This allows the user to see from a distance what is going on with each machine without walking over to the PC screen (Simplified user view in MOS V11)
- Presser foot adjustment button (Simplified user view in MOS V11)








Hazards of Operation

There are risks in operating any mechanical equipment, the following is intended to elevate your awareness of both the areas of risk and the meaning of the warning signs located on the machine. Always refrain from interfering with mechanical or electromechanical parts while in operation unless otherwise specified in this manual.

	<p>Laser Beam</p> <p>Do not look directly into the laser beam.</p>
	<p>Take-up Lever Oscillation</p> <p>Do not touch the take-up levers during operation.</p>
	<p>Needles During Operation</p> <p>Do not place body parts or other foreign objects under the needles during operation.</p>
	<p>Needle Case Movements</p> <p>Do not place hands or other objects on or around the needle case during operation.</p>
	<p>Rotary Hook Rotation</p> <p>Do not attempt to change bobbin thread during operation. Do not place hands or other objects in the rotary hook area during operation. Do not operate the machine without the hook guards in place.</p>
	<p>Cap Frame Pinch Points</p> <p>Do not touch the cap frame, driver, or driver bar during operation.</p>
	<p>Pinch Points (x-carriage)</p> <p>Do not rest hands or other objects on the tabletop during operation. Do not reach behind the x-carriage during operation with or without tabletop in place.</p>

Dangers de Service

Le tableau suivant montre des zones de risques ou points de danger qu'on peut rencontrer lors du service. Portez toujours des lunettes protectrices lors du maniement de la machine pour éviter des blessures corporelles en cas d'une casse d'aiguille.

	<p>Rayon laser</p> <p>Ne regardez pas directement au rayon laser.</p>
	<p>Oscillation releveur de fil</p> <p>Ne touchez pas les releveurs de fil lors du service.</p>
	<p>Aiguilles lors du service</p> <p>Ne mettez pas de parties corporelles ou d'autres objets étrangers au-dessous des aiguilles lors du service.</p>
	<p>Mouvements du boîtier d'aiguilles</p> <p>Ne mettez pas vos mains ou d'autres objets sur ou autour du boîtier d'aiguilles lors du service.</p>
	<p>Rotation de la navette rotative</p> <p>N'essayez pas de changer le fil de canette pendant le service. Ne mettez pas vos mains ou d'autres objets dans la zone de la navette rotative lors du service. Ne manoeuvrez pas la machine, si les gardes-crochet ne sont pas bien en place.</p>
	<p>Points de pincement au cadre casquette</p> <p>Ne touchez pas le cadre casquette, l'entraînement ou la barre d'entraînement lors du service.</p>
	<p>Points de pincement (support X)</p> <p>Ne mettez pas vos mains ou d'autres objets sur la table lors du service. Ne touchez pas l'arrière du support X lors du service avec ou sans table en place.</p>

Safety Warnings

The list below specifies safety warnings that you should heed during normal operation and maintenance of your machine.



Do not attempt to lubricate the machine while it is in operation.



Failure to engage the emergency stop button on the machine keypad while removing or replacing needles can result in the machine starting through machine or operator error. This can result in damage to the machine and/or serious personal injury.



Never attempt to remove or insert the bobbin while the machine is operating.



Do not operate the machine without the covers being installed. Moving parts can cause crushing and pinching injuries. In addition, fabric and other materials can get caught in the moving belts and gears and damage the machine.



Do not adjust the presser foot height while the machine is sewing. Doing so can result in serious injury.



Do not attempt to pull on or trim threads near moving needles. This can result in painful injury.



The lubricants specified in the Software and Technical manuals contain known carcinogens. Do not allow lubricants to come into contact with your eyes, mouth, or nose. Always wash your hands thoroughly after performing lubrication procedures.



When using solvents to clean components in the machine, always ensure adequate ventilation. Allow all solvents to completely evaporate before turning the machine back on to prevent shorting out electrical components. Vapors from most solvents are both toxic and flammable. Dispose of rags soaked with solvent properly.



You must unplug the machine before replacing the power switch fuse.



The following table lists specific safety warnings that you should heed when you perform procedures (such as repairs and technical adjustments) that extend beyond normal operation and maintenance.

Area Of Machine	Warning
Entire Machine	<p>Personal injury may result if proper precautions are not observed. Remove rings, watches, and any other metallic objects from hands and wrists before servicing the machine. Remove metallic articles from shirt pockets to prevent them from falling into the machine. Do not allow loose clothing to come into contact with moving parts of the machine. Under certain conditions of machine failure, the moving parts of the machine may not be controllable by normal means. At these times, the machine may operate without notice.</p> <p>Failure to practice good maintenance and repair technique may result in injury to personnel performing the work and/or damage to the equipment. The warranty is exclusive of, and may be VOID if poor maintenance practices have caused damage to the equipment.</p> <p>Failure to use a grounding strap, or failure to practice other good maintenance/repair techniques may cause damage to the machine and possible personal injury. DO NOT attempt to use any grounding strap that is not specifically designed for static use. A "straight-wire" grounding device (one without built-in resistance) will place the operator in danger of exposure to dangerous voltages. It is recommended that the static strap be checked during daily use for proper resistance protection.</p> <p>DO NOT operate the machine with the lower rear cover removed, except when indicated by the instructions in the Technical Manual. Operating the machine without the covers creates a risk of severe electrical related injury.</p>
Harnesses	Always turn the power off before disconnecting or connecting any harness. At the minimum engage the emergency stop button.
36V Power Harness	Do not attempt to repair a damaged 36V power harness if the wiring insulation is damaged through chafing, nicks or cuts, or if the wires were overheated due to an over-current machine error. Never handle the 36V power harness unless power to the machine is completely disconnected. Do not rely on the power switch to break the power supply to the machine.

Area Of Machine	Warning
Power Supply	<p>Lethal voltages exist inside the power supply unit, at the back side of the electrical supply input connector, and in the wires between the two. If you plan to do any work with any of these components, turn the power switch off and disconnect the electrical input supply cord from the machine.</p> <p>It is very important that the power cord is plugged into a properly wired electrical outlet. Failure to have a properly wired outlet may result in damage to the equipment and personal injury. It is recommended that a licensed electrician be consulted to ensure that the electrical outlet is properly wired and grounded. If a properly wired electrical outlet is not used for the source supply voltage to the system, electrical failures may result.</p> <p>Do not attempt to disassemble the power supply unit for any reason. There are no user serviceable components inside. Internal components in the power supply unit might still have residual voltage (even if power is disconnected) that can cause painful electrical shock.</p> <p>Do not attempt to replace or service any component in the rear of the lower bed without disconnecting the A/C power input cord. Failure to do so will leave the power supply and power switch energized with dangerous levels of voltage even when turned off and can result in severe injury from electrical shock.</p>
Laser Assembly	<p>The laser assembly replacement procedure is intended to be performed only by specially trained Melco service technicians and personnel. Disassembly by untrained individuals will void any warranty protection and can result in personal injury or damage to the machine.</p> <p>DO NOT install laser assembly until the machine is turned OFF!!! Failure to turn the machine off may result in personal injury or damage to the machine.</p> <p>The laser light adjustment procedure is intended to be performed only by specially trained and authorized Melco service technicians and personnel. Disassembly by untrained individuals will void any warranty protection and can result in personal injury or damage to the machine.</p> <p>DO NOT allow the laser beam to be aimed at yours or anyone else's eyes. The laser emits a very concentrated light beam that can cause permanent blindness. Use extreme care in handling the laser assembly to make sure it is not going to be inadvertently aimed at someone's eyes or face. DO NOT LOOK DIRECTLY AT THE LASER LENS WHILE IT IS ENERGIZED!</p>
LED Cluster Assembly	<p>The LEDs may be hot to the touch when illuminated. They must be turned off for a few minutes before handling or they can cause minor burns.</p>
Movable Knife	<p>Keep clear of the moving parts that are exposed during the movable knife adjustment procedure.</p>

Area Of Machine	Warning
Needle Case	During needle case removal, once you have completed the first two steps of the procedure. Do not proceed without engaging the emergency stop button or by turning the machine off. The machine may begin operating if you do not do so. This can result in severe damage to the machine and/or personal injury. You do not need to disconnect the power input cord from the machine.
Trimmer Drive Assembly	The Trimmer Drive Assembly replacement procedure requires removal the lower arm rear cover from the back of the machine. DO NOT place your hands into the back of the lower bed while the A/C input cord is connected to the machine. Failure to disconnect the A/C power input cord can result in potential electrical shock if you inadvertently touch the back of the power switch or the wiring to the power supply.
X/Y Home PCB	A small risk exists of unpredictable movement of internal parts when the optical sensors are disconnected. This creates a risk of personal injury if parts suddenly move. Always turn off the machine before disconnecting optical sensors.
Y-Motor Assembly	Risk of serious personal injury exists when handling internal motors, belts, and cabling due to electrical shock and moving parts hazards. Always turn off the embroidery machine when working on or adjusting motors, belts or gears.
Z-Home Sensor PCB	The Z-Home Sensor PCB replacement procedure requires the removal of the left and right transparent arm covers and the upper arm back cover. Do not remove the covers off the machine without either turning the machine off or engaging the emergency button. The motors might move when the sensor is removed or the harnesses are disconnected.

Avertissements de sécurité

Le liste ci-après comprend avertissements de sécurité spécifiques que vous devriez rappeler lors du service normal et lors de l'entretien de la machine.



N'essayez pas de lubrifier la machine lorsqu'elle est en marche.



N'oubliez pas d'actionner le bouton d'arrêt d'urgence de la machine si vous voulez enlever ou remplacer des aiguilles sinon vous risquez que la machine commence à marcher à cause d'une erreur de machine ou par l'opérateur. Vous risquez des dommages de la machine et/ou de graves blessures corporelles.



N'essayez jamais d'enlever ou installer la bobine lorsque la machine est en service.



Ne manœuvrez pas la machine sans recouvrements installés. Des pièces mobiles peuvent causer de blessures de pincement et d'écrasement. De plus, le tissu et d'autres matériaux peuvent être attrapés dans des ceintures et entraînements mobiles et endommager la machine.



Ne réglez pas la hauteur du pied presseur lorsque la machine est en train de broder. Sinon vous risquez de graves blessures.



N'essayez pas de tirer ou couper des fils à côté des aiguilles mouvantes. Vous risquez de graves blessures.



Les lubrifiants indiqués dans les Instructions de service et techniques contiennent de carcinogènes connues. Évitez que les lubrifiant entrent en contact avec vos yeux, votre bouche ou nez. Lavez toujours bien vos mains après avoir réalisé des procédures de lubrification.



Si vous utilisez des détergents pour nettoyer des composants de la machine, veuillez toujours vous assurer qu'il y a assez de ventilation. Il faut que les détergents soient complètement évaporés avant de remettre la machine en marche pour éviter des courts-circuits des composants électriques. Les vapeurs de la plupart des détergents sont toxiques et inflammables. Éliminez les torchons imbibés de détergent soigneusement.



Vous devez débrancher la machine avant de remplacer le fusible de sécurité.

Le tableau suivant comprend des avertissements de sécurité spécifiques que vous devriez respecter lors des travaux de réparation, des réglages techniques ou d'autres procédures qui sont hors le service normal ou d'entretien.

Zone de la machine	AVERTISSEMENT!
Machine entière	<p>Des blessures corporelles peuvent être causées en cas de non-respect des précautions soigneuses. Enlever des anneaux, montres et d'autres objets métalliques de vos mains et bras avant de faire marcher la machine. Enlevez des articles métalliques des poches de chemise pour empêcher qu'ils tombent dans la machine. Faites attention que des vêtements lâches entrent en contact avec des pièces mobiles de la machine. Au cas où la machine est en panne, il est possible que les pièces mobiles ne puissent plus être commandées proprement et la machine marche sans contrôle.</p> <p>Défaut d'appliquer une bonne technique d'entretien et de réparation peut causer des blessures au personnel travaillant à la machine et/ou endommager l'équipement. La garantie ne comprend pas de pratiques d'entretien mauvaises et sera NUL, si celles-ci ont endommagé l'équipement.</p> <p>Défaut d'utiliser une bande de mise à la terre ou défaut d'appliquer d'autres techniques d'entretien /de réparation peut endommager la machine et éventuellement causer de blessures corporelles. N'essayer PAS d'utiliser n'importe quelle bande de mise à la terre qui n'est pas construite spécifiquement pour l'utilisation statique. Un dispositif de mise à la terre "par fil métallique direct" (un sans résistance intégrée) posera l'opérateur en danger d'exposition à des voltages dangereux. Il est recommandable de vérifier la bande statique pendant l'utilisation journalière pour protéger la bonne résistance.</p> <p>Il NE faut PAS manoeuvrer la machine si le recouvrement arrière en bas a été enlevé, sauf si indiqué par les instructions du manuel technique. Faire marcher la machine sans recouvrement provoque un risque de blessures graves dues au système électrique.</p>
Le câblage	<p>Veillez toujours couper le circuit avant de débrancher ou brancher des câbles. Au moins appuyez sur le bouton d'arrêt d'urgence.</p>
Câbles électriques à 36V	<p>N'essayez pas de réparer un câble 36V endommagé si l'isolation de fil a été endommagée par friction, des entailles ou coupures ou si les fils ont été surchauffés à cause d'une erreur de machine de courant de surcharge. Ne jamais touchez le câblage 36V si le courant de la machine a été complètement coupé. Ne comptez pas sur l'interrupteur de courant pour couper le circuit à la machine.</p>

Zone de la machine	AVERTISSEMENT!
Alimentation électrique	<p>A l'intérieur du système d'alimentation électrique, à l'arrière du connecteur d'entrée de l'alimentation électrique et aux fils entre les deux, il y a des tensions mortelles. Si vous avez l'intention de travailler sur un de ces composants, coupez le circuit et déconnectez le câble d'alimentation électrique de la machine.</p> <p>Il est très important que le câble électrique soit bien branché sur une prise électrique correctement installée. Défaut d'avoir une prise bien installée peut endommager l'équipement et causer des blessures corporelles. Il est recommandé de consulter un électricien autorisé pour vous assurer que la prise électrique a été installée correctement et mise à la terre. Si l'on n'utilise pas de prise électrique bien installée pour l'alimentation électrique du système, on aura de défauts électriques.</p> <p>N'essayez pas de démonter le système d'alimentation électrique pour n'importe quelle raison. Il n'y a pas de composants utiles à l'intérieur pour l'utilisateur. Les composants intérieurs du système d'alimentation électrique peuvent toujours avoir de la tension résiduelle (même si le circuit a été coupé) qui pourrait causer des chocs électriques douloureux.</p> <p>N'essayez pas de remplacer ou d'entretenir des composants à l'arrière du fond bas sans déconnecter le câble d'alimentation électrique C/A. Défaut de le faire provoquera que l'alimentation électrique ainsi que l'interrupteur soient toujours alimentés ayant des niveaux de tension dangereux, même si débranché, et pourra résulter en des blessures graves dues au choc électrique.</p>
Système Laser	<p>La procédure de remplacement du système Laser ne doit être faite que par des techniciens d'entretien et du personnel Melco spécialement entraînés. Le démontage par des personnes non entraînées annulera toute protection de garantie et peut causer des blessures corporelles et endommager la machine.</p> <p>Installez le système Laser seulement si la machine a été mise HORS SERVICE!!! Défaut de mettre la machine hors service peut causer des blessures corporelles ou endommager la machine.</p> <p>La procédure d'ajustage de la lumière Laser ne doit être faite que par des techniciens et du personnel Melco spécialement entraînés et autorisés. Le démontage par des personnes non entraînées annulera toute protection de garantie et peut causer des blessures corporelles et endommager la machine.</p> <p>Il faut faire ATTENTION que le rayon du Laser NE soit PAS dirigé vers vos yeux ou des yeux de quelqu'un d'autre. Le Laser émettra un rayon lumineux bien concentré qui peut causer d'aveuglement permanent. Soyez extrêmement prudent en manoeuvrant le système Laser pour vous assurer qu'il ne soit pas dirigé par inadvertance aux yeux ou à la figure de quelqu'un. NE JAMAIS REGARDER DIRECTEMENT DANS LA LENTILLE DU LASER LORSQU'ELLE SE TROUVE EN SERVICE!</p>

Zone de la machine	AVERTISSEMENT!
Système Groupe DEL	Les lampes DEL peut être trop chaudes pour les toucher quand elles sont illuminées. Il faut les débrancher pendant quelques minutes pour pouvoir les toucher et pour éviter de petites brûlures.
Couteau mobile	Eloignez-vous des composants mobiles qui sont exposés pendant l'ajustage du couteau mobile.
Boîtier d'aiguilles	Lors de l'enlèvement du boîtier d'aiguilles, après avoir terminé les deux premiers pas de la procédure, ne procédez pas sans avoir appuyé sur l'arrêt d'urgence ou mis la machine hors service. La machine pourrait se mettre en marche si vous ne le faites pas. Ainsi la machine ou des personnes pourraient être endommagées gravement. Il ne faut pas déconnecter le câble d'alimentation électrique de la machine.
Système d'entraînement du coupe-fil	Pour remplacer le système d'entraînement du coupe-fil il sera nécessaire d'enlever le recouvrement du bras arrière en bas de l'arrière de la machine. NE mettez PAS vos mains dans l'arrière du fond bas pendant que le câble d'alimentation C/A est connecté à la machine. Défaut de déconnecter le câble d'alimentation électrique C/A peut causer des chocs électriques graves si vous touchez l'arrière de l'interrupteur ou le câblage vers le dispositif d'alimentation électrique par inadvertance.
Position originale X/Y Carte à circuits imprimés	Il y a un petit risque de mouvements imprévus des composants intérieurs si les détecteurs optiques sont déconnectés. Cela causera un risque de blessures corporelles si des composants bougent soudain. Mettez toujours la machine hors service avant de déconnecter les détecteurs optiques.
Système Moteur Y	Il y a un risque de blessures corporelles lorsqu'on touche des moteurs intérieurs, des ceintures et du câblage qui est dû au choc électrique et danger des pièces mobiles. Mettez toujours la machine à broder hors service si vous travaillez ou ajustez des moteurs, ceintures ou engrenages.
Position originale Z détecteur Carte à circuits imprimés	Pour remplacer le détecteur Cartes à circuits imprimés de la position originale Z il faut enlever les recouvrements des bras transparents à gauche et à droite et le recouvrement du bras arrière en haut. Il ne faut pas enlever les recouvrements sans avoir mis la machine hors service ou appuyé sur le bouton d'arrêt d'urgence. Les moteurs pourraient bouger si les détecteurs ont été enlevés ou le câblage a été déconnecté.

Safe Operating Principles

The following list contains some safe operating principles you should follow when operating the machine.

- No untrained persons should be permitted within the designated working area around the machine.
- No untrained persons should operate the machine.
- This machine will embroider stitches in a safe and controlled manner when used as outlined throughout this documentation.
- Thread break sensors stop the machine automatically when a fault changing thread feed dynamics is detected, this stoppage is normal and recovery from such a stop is explained in this manual.
- The machine will stop operation at the end of each design automatically, do not attempt to manually stop an operating machine in anyway other than what is described in this manual.
- DO NOT interfere with moving machine parts during operation.
- Only after the machine has stopped should you interact with it.
- DO NOT wear loose or baggy clothing or jewelry while operating the machine.
- ALWAYS wear eye protection when operating your machine.
- Keep the working area clean and free from any objects that may interfere with the normal movements of the machine.
- Keep up on the required maintenance. This not only ensures safe operating conditions, but will also maintain a quality sew out and extend the life of the machine.
- Read the entire manual prior to operation.

Specifications

For indoor use only.

Type/# of Heads	Upper Arm-Lower Arm/1 to 30 Modular
# Needles	16
Maximum Tubular Frame Size (XxY)	500mm x 430mm (19.7" x 16.9")
Maximum Sew Field/Tubular Frame (XxY)	400mm x 410mm (15.7" x 16.1")
WA Cap Frame	360mm x 82mm (14.1" x 3.25")
Conventional Cap Frame	152mm x 70mm (5.9" x 2.75")
Min/Max Sew Speed Flats	300-1500 spm
Min/Max Sew Speed Caps	300-1200 spm
Stitch Length Range	Only Limited by Hoop Size
User Interface	Melco OS
Machine Configuration	Up to 30 individual machines, connected by Ethernet
Self-Diagnostics Capability	Retrieves relevant machine data for troubleshooting
Simplified User Interface	Step by Step Guide Software
Design Memory	Limited only by hard drive, Max file size 500k
Pre-Sew Trace	Laser
Needle to Garment, Garment to Hoop Position	Laser Positioning System
Thread Feed Technology	Patented Acti-Feed
Thread Break Detection	Upper & Lower Electronic Force Gauge Sensor
Automatic Stitch Backup	Yes
Automatic Trimmer	Yes
Lighting Type Cold Bright	Cold bright LED
Power Supply (V)	90-260V (Single Phase, 50/60 HZ, 4A), Class I (Grounded)
Power Consumption (W)	Typical: 200 Watts Max: 650 Watts
Temperature Range	15-40° C
Humidity	Max 85% Relative Humidity
Installation Category (overvoltage)	II
Pollution Degree	2
Motor Type(s)	Servo, Stepping
Motor Capacity (kV)	X and Z: 100 Watts Y: 250 Watts
Machine Construction Material	Aluminum
Physical Specifications with Cart	
Width	724mm (28.5")
Height	1669mm -3mm damper compression (65.7")
Depth	779mm (front caster w/ brake extended) (30.7")
Weight	95.5kg (210.5 lbs)

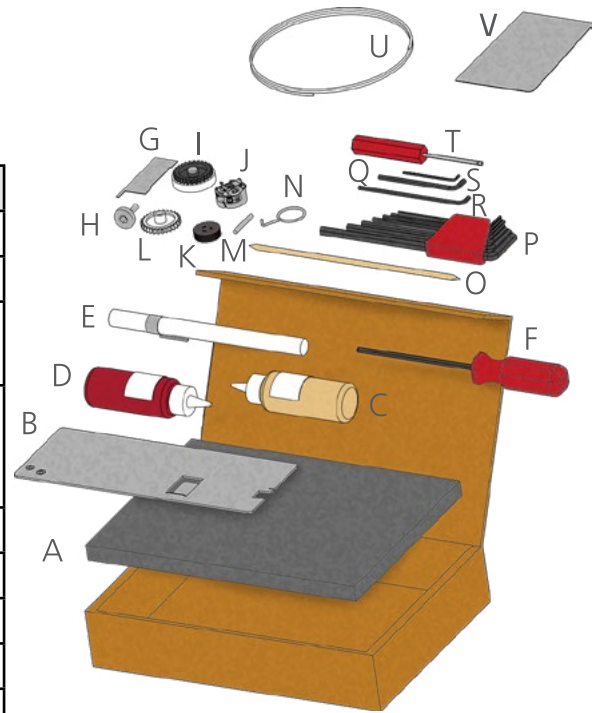


Physical Specifications without Cart	
Width	724mm (28.5")
Height	952mm (-3mm damper compression, thread tubes 70mm extended) (374.8")
Depth	741mm (29.2")
Weight	74.6kg (164.5lbs)

Operator's Kit Contents

The Operators Kit contains many of the tools required for the assembly of the cart and initial maintenance of the machine. The rest of the tools will be used in other adjustments and procedures of your machine.

Item No.	Qty.	Part No.	Description Notes
A	1	34030	Foam, Operators Kit
B	1	33909	Gauge, Tension, X-Cable
C	1	32078-01	Grease, Emb Polymer, 2 Oz. Squeeze Bottle
D	1	34463-01	Grease, High Performance, 2 Oz. Squeeze Bottle
E	1	34275	Oiler, Pen
F	1	010468-01	Hex Driver, Ball End, 4mm
G	1	009027-01	Gauge, Combination
H	1	12392-01	Thumb Screw
I	1	30615-06	Thread Feeder Roller
J	1	34396	Bobbin Case
K	1	34464	Thread Feeder Pinch Roller
L	1	30617	Thread Feeder Gear
M	1	34274	Needle Orientation Magnet
N	1	34509	Thread Feed Roller Extraction Tool
O	1	34277	Grease Applicator Stick
P	1	32022	Set, Hex Key, Metric, Long, 7 Piece W/Holder
Q	1	32189	Wrench, Hex, Ball End, 2.5Mm, Short Arm
R	1	010701-02	Wrench, Hex, 3Mm, Short Arm
S	1	34645	Wrench, Hex, 1.5mm Short Arm
T	1	32023	Screwdriver, Straight, Small
U	1	006795-01	Monofilament
V	1	30727-03	Label, Menu, User Interface



Unpacking the Machine

If your machine was delivered, this may have been completed by the delivery service. It is still recommended that you reconcile your shipment with your packing list. It is important to check the packing list instead of the invoice. The invoice will show all items that were ordered, but the packing list will indicate if any items are on back order.

Setting up the Machine

If the machine was not delivered, the following instructions will walk you through unpacking your machine. Please read these instructions completely before proceeding. You will also need to assemble the cart prior to fully unpacking the machine. Instructions for cart assembly follow the unpacking instructions.

1. Remove the outer packing/holding straps by cutting them.



2. Remove the options box and set aside.
3. Remove the main lid and carefully lift the exterior box up and away from the machine.



4. Cut the packing/holding straps securing the machine to the box/pallet. Remove any additional loose packaging, boxes, and foam spacers.



5. Locate the four handles in the packaging. They will be contained in their own box. Place two handles on each side of the machine. On each leg, the handles should be close to the front and one close to the back. There are cuts in the base box to make this easier to accomplish.
 - a. To place the handle, align the angled edge to the t-channel in the leg of the machine base.



- b. Rock forward and lift slightly up on the handle to rotate it into place.



6. With two people, lift the machine using the handles on both sides of the machine.



Do not attempt to lift the machine alone. Always move the machine with two people.

Each person should attach and use the handles for each side of the machine. When moving the machine, take care not to apply pressure against the needle case.

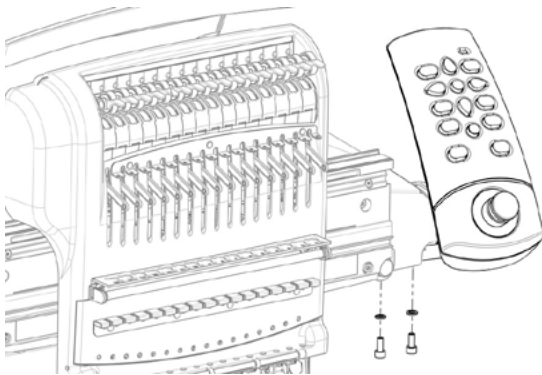
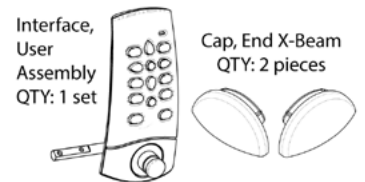
- Place the machine on the assembled cart so that the padded feet of the machine fall into the holes on the tops of the machine cart.



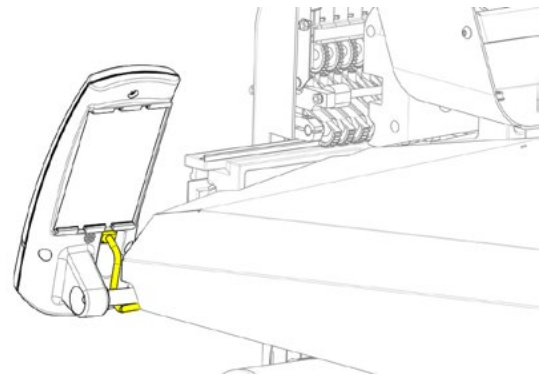
Make sure the back support of the cart is to the back and the locking casters are in front.

Install the Machine User Interface and X-Beam End Caps

- Locate the box containing the user interface and end caps. The box is labeled with the image to the right.
- Attach the user interface assembly.

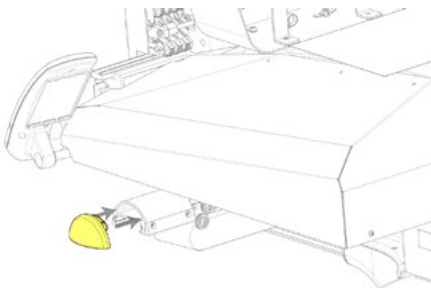


Using the two screws and two lock washers that came with the user interface assembly, attach the interface as shown in the image using a 4mm hex wrench.



Route the network cable (shown in yellow) from under the right side machine cover, under the user interface mounting bolt, and plug into the back of the user interface assembly.

- Insert the X-beam end caps on either side of the x-beam as shown in the image below.



Machine Overview

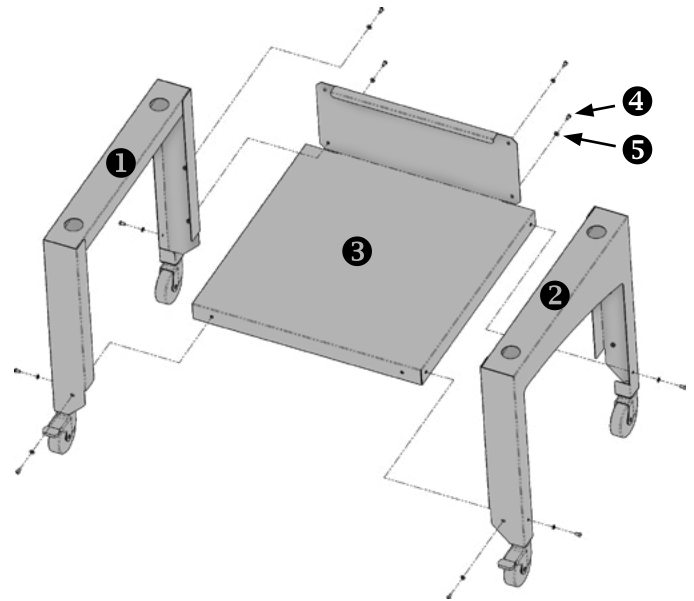


Cart Assembly

The cart consists of the items assembled as shown in the figure to the right. This assembly requires a 4mm hex wrench like the one included in the operator's kit.

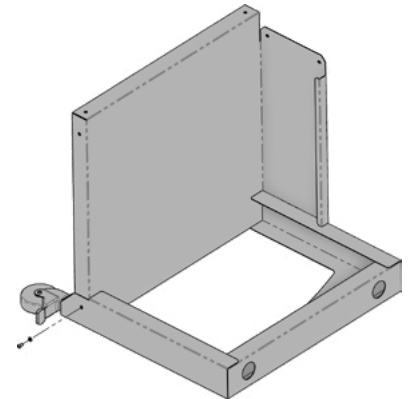
Item	Qty.	Description
1	1	Left Cart Leg
2	1	Right Cart Leg
3	1	Cart Shelf
4	10	Zinc Btn Hd Cap M5 X 0.8 X 8mm Screw
5	10	Washer, Flat, M6

It will most likely be easiest to assemble the cart on the floor. If you are concerned with marking up the cart, first place down a large piece of cardboard or a blanket.



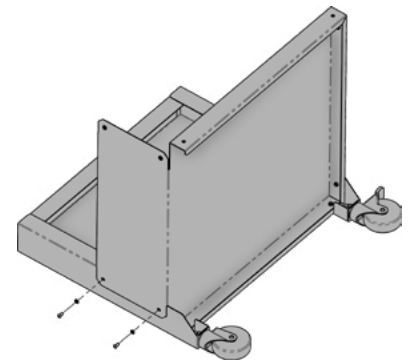
Stage 1

4. Place Right Cart Leg flat with the outside surface of the leg facing down. The outside surface is the side with the curve cut into the face.
5. Position the Cart Shelf with the back support on the leg without the locking caster. The shelf should slide into the lower cutout section of the side supports of the legs.
6. Loosely assemble a screw and washer into the front section of the leg and shelf. They will be fully tightened during a step.



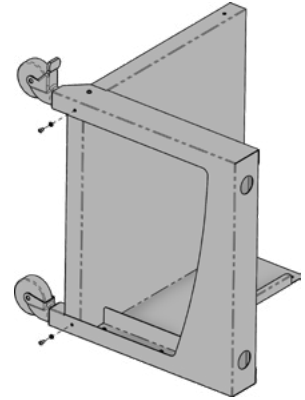
Stage 2

7. On the back, loosely assemble two screws and two washers into the back support of the cart and the back of the leg. They will be fully tightened during a step.



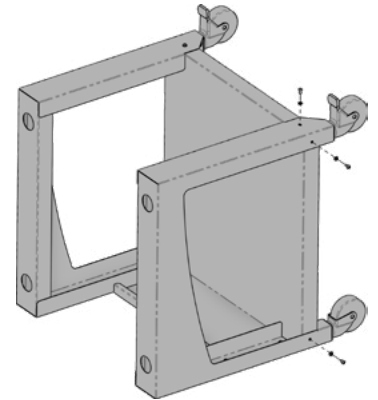
Stage 3

8. Position the cart so the back surface is down.
9. On the outside surface of the legs, loosely assemble two screws and two washers into the leg and shelf. They will be fully tightened during a step.



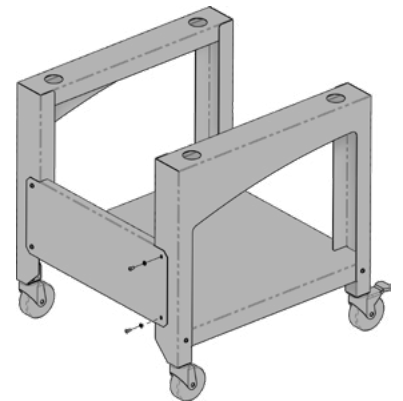
Stage 4

10. Position the left leg so the cart shelf is inside the lower cutouts of the legs. Make sure the locking caster is on the leg portion facing up.
11. Loosely assemble the three sets of screws and washers into the leg and cart as shown. They will be fully tightened during a step.



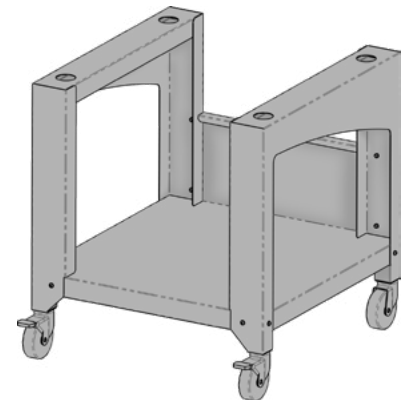
Stage 5

12. Position the cart on the casters as shown.
13. On the back, loosely assemble two screws and two washers into the back support of the cart and the back of the leg. They will be fully tightened during a step.



Stage 6

14. Tighten all screws.
15. Cart Assembly is complete!



Software Activation & Deactivation

Melco OS can use a virtual security key as opposed to a physical one. This means that if no physical security key is present when you initially launch your software, you will be prompted to activate the product using the product serial number.

If a physical security key is present and attached to a USB port, this screen will be bypassed and the appropriate level of software will be launched.

Melco OS may be installed on multiple computers, but only one activated software is allowed at one time. One activation is allowed per product serial number at any given time.

Lite

If the product is not activated, it can run in Lite.

Lite is a version of the software that allows for the running of the machine, but limits are applied to sew field, sew speed, and various other settings. It will also force the software into the advanced interface.

To run in Lite, click on the Lite button on the first Product Activation page.

Product Activation

To activate the product:

1. In the initial activation page that comes up when you launch the software, enter the following information:
 - Product Serial Number - This number is most likely found on the software package. Do not lose this number.
 - Device Identification Number - This number will be generated by the software and entered for you.
 - Activation Code - If you are connected to the Internet, you may attempt to automatically obtain this number by clicking the Activate button. This is the fastest and easiest way to activate your software.
 - If you are not connected to the Internet, follow the on screen instructions to obtain an activation code through an alternative Internet-enabled device.



Product Deactivation

To deactivate the software and free the license for use on another device, follow the steps below:

2. Access the product deactivation page using one of the following methods:
 - Go to Tools>Deactivate Product.
 - Go to Tools>Security, and click on the Deactivate button in the General tab.
3. Follow the on-screen instructions and retain the deactivation code

Machine Connections

This section will describe how to correctly connect the power and communications cables to the machine and the computer.

An Ethernet network connection is required for communication between the computer and the machine. This connection must be established in order to control and send designs to the machine.

The method for connecting the machine to the computer will vary depending on the number of machines.

Materials Required

To connect a machine, you will need the following items:

- 1 power cable
- 1 crossover cable OR 1 Ethernet switch and 2 Ethernet cables

Note: A crossover cable is a network cable in which the wires are crossed over. This switches the receiving and transmit signal pins on either side. If connecting directly from the machine to the computer, a crossover cable must be used.

Do Not Share Networks

The machines cannot share network communications with the internet. The computer may have access to the internet, but it must be accomplished through a separate network connection. A separate network card, either wireless or Ethernet, will need to be used for the internet connection.

Connecting the Power Cables

4. Locate the power cable you will be using with your machine.
5. Locate the power cable plug in the rear of the machine.
6. Make sure the machine power switch is in the OFF position. Plug the power cable into the inlet.



If you are using a line conditioner, as recommended, plug the other end of the cable into the dedicated line conditioner.

7. Connect the line conditioner into a power source.

Connecting the Network Cable (Single Machine)

For a single machine to computer connection, a crossover cable is required. (You can also use 2 Ethernet cables and an Ethernet switch).

1. Connect one end of the crossover cable into the Ethernet jack on the machine.

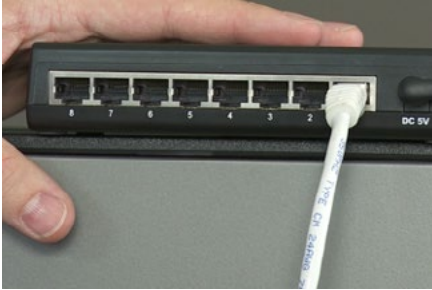


2. Connect the other end of the crossover cable into the Ethernet jack on the computer. The location of this network connection will vary from computer to computer. If using multiple network cards, it may be helpful to label them on the back of the computer.
3. Move on to Selecting the Connection.

Connecting the Network Cables (Multiple Machines)

For connecting multiple machines to the computer, an Ethernet switch device and cables are required. The switch is a small electronic device that allows multiple devices to be connected through a network. You can connect as many machines as your switch will allow.

1. Connect the Ethernet switch power cable to the switch and a power source.
2. At least two Ethernet cables are required with the switch. Connect one end of the Ethernet cable into any port on the switch.

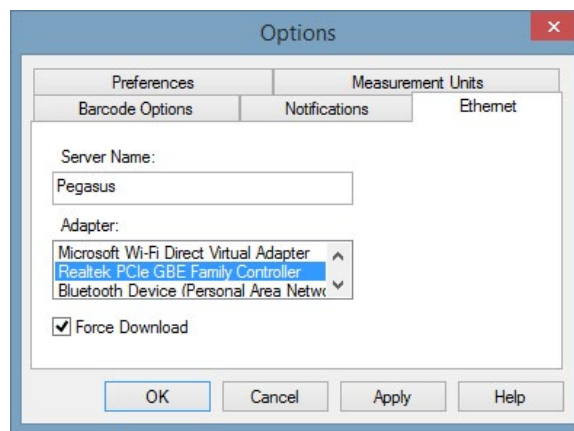


3. Connect the other end of this cable directly into the Ethernet port on the computer.
4. Now using another cable, connect one end into a different port on the switch.
5. Connect the other end into the cable port on the first machine you want to connect.
6. If there are other machines, continue to connect the next cable(s) from the Ethernet switch to the machine(s).
7. If all the machines are connected, you may now move on to Selecting the Connection.

Selecting The Connection

Before a connection can be established, the appropriate connection port must be selected in the software.

1. Launch the software by double tapping the software icon.
2. Select Tools>Options>Ethernet Tab from the menu bar at the top of the screen. This step is usually only required for the initial power up.
 - a. Ensure that the Ethernet adapter/card that is connected to your machine(s) is selected (left-click to select)
 - b. Turn on Force Download by checking the box beside it.
 - c. Click OK.



Powering Up the Machine

This section will describe how to correctly power up the machine.

Initial Power Up Sequence

1. Make sure that all of the machines are turned off.
2. Make sure the software the software is launched and the Main Screen is being displayed.
3. Make sure the E-Stop is disengaged by turning it in the direction of the arrows.



4. Power up the machine with the power switch.



5. The software will load CSA and RSA files to the machine, and the machine will initialize and display on screen.

i *If your machine is switched on but will not initialize fully, check the E-stop. If the E-stop is engaged, the motors cannot function to move the machine to a home position and will not allow it to initialize. The machine will give a series of short beeps to indicate that the e-stop is engaged when powering up. If you notice this, simply disengage the e-stop by turning it in the direction of the arrows and releasing the button. The machine will now be allowed to move to the home position and fully initialize.*

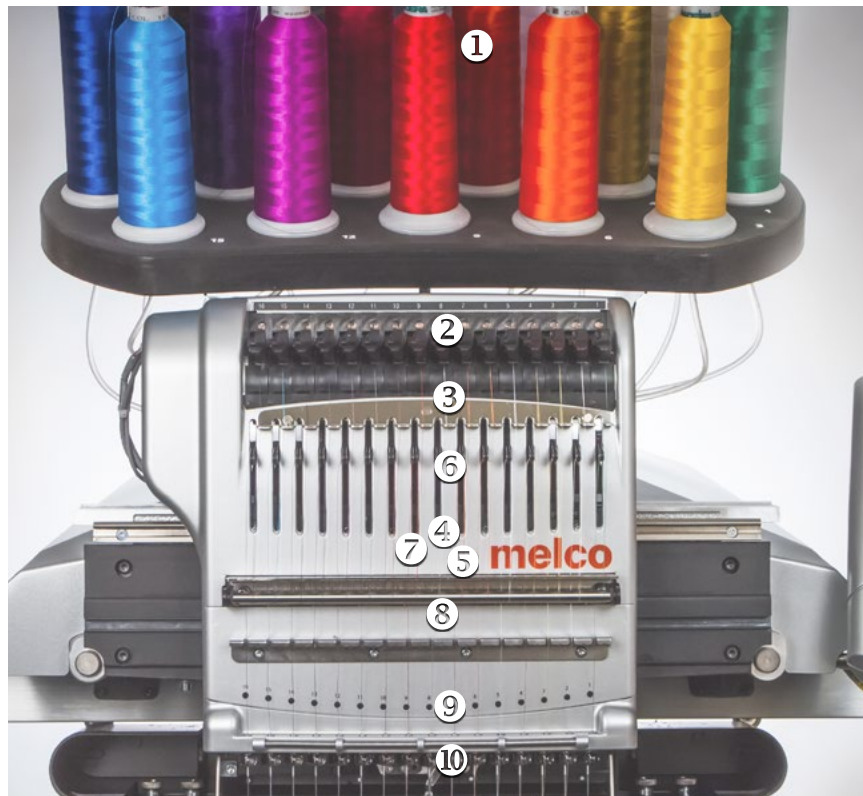
Upper Threading

The proper thread path from the cone of thread to the eye of the needle is critical in the operation of the machine. Ensuring that the thread moves along the appropriate route will help prevent thread breaks as well as increase efficiency and sew quality. Understanding the upper threading will also help in troubleshooting.

The following image displays the main components of the needle case and the upper threading system.

Threading the Machine for the First Time

When you first receive your machine, there will be thread in the system. The tops of the thread will most likely be taped to the side of the thread tree. Remove the tape and untwist the threads. New cones of thread may now be placed on the thread tree using the quick thread change method below.



Thread Cones or Thread Spools

Smaller spools of thread often perform better when seated on a coaster. These coaster help prevent the thread from catching on the bottom of the spool when casting off.

Using Thread Clovers

Some larger cones of thread have a larger inner diameter than others. If the cones are loose and wobble, using a thread clover can help stabilize the cone. This prevents the cones from shaking and casting off while in use.

To use the clovers:

1. Push the clover over the thread tube.



2. Collapse the clover to the thread tube as the cone is loaded onto the machine.



3. Releasing the clover will cause it to expand inside the cone core and stabilize the thread cone.

Quick Thread Change

Changing a cone of thread does not require rethreading the entire thread path. If thread is already in the system, the fastest and easiest way to change a cone of thread is to remove the old cone but leave a good length of the old thread on the machine.

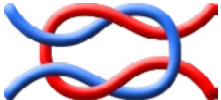
1. Place the new cone of thread on the thread tree with the old thread end sticking out of the thread tube and over the new cone.



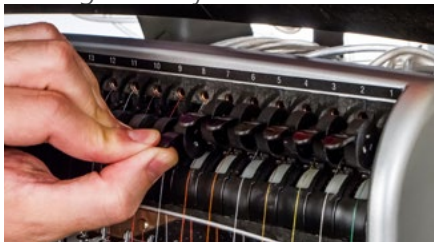
2. If used, black clover may need to be collapsed to allow the new cone onto the thread seat. If the clover is too low on the thread tube, the new cone of thread may not be able to sit securely on the thread seat. If this is the case, move the clover up the thread tube and try again.
3. If the thread is caught in the clover, pull up slightly on the clover to create a loop of thread that you can grab. Pull the thread up through and free of the hole in the clover.
4. Extend the thread tube $\frac{1}{2}$ to 1 inch above the cone. Neglecting to extend the thread tube $\frac{1}{2}$ to 1 inch above the cone could result in frequent thread breaks.
5. After placing the cone of thread on the machine, the old thread will be trapped on the inside and underneath the cone. From near the tube, pull the thread free and over the top of the new cone.



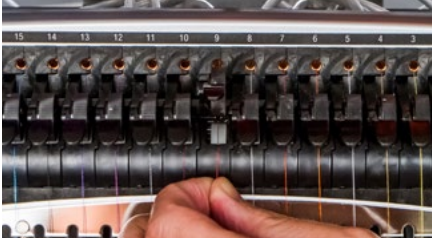
6. Tie the end of the old thread to the end of new thread using a square knot.



7. Lift the pinch roller and carefully pull the thread from the back of the needle. This will pull the new thread completely through the system. If the knot is tight and small enough, it will even slip through the eye of the needle.



- When finished, line up the thread under the pinch roller and press the pinch roller back down.



- If desired, the thread can then be held by the retaining spring in front of the lower thread guide or held in place using the grabber. With your hands out of the way, press the adjustment and center keys on the keypad simultaneously to close the grabber and move the thread into the holder behind the needles.



- Trim the end to about an inch in length.
- Press the keys again to open the grabber.

Upper Thread Path

If the thread comes out of the system, you may need to thread the machine without a starter thread.

- To start a new cone of thread, push the plastic thread tubes up from behind the thread tree. Place the cone of thread on the thread seat. The thread tube should extend $\frac{1}{2}$ to 1 inch above the cone. Neglecting to extend the tube $\frac{1}{2}$ to 1 inch above the cone could result in frequent thread breaks.



- Using either the mono-filament provided in the operator's kit or a can of compressed air, feed the thread through the thread tube from the cone to the small hole behind the thread feeder assembly.
 - To use the monofilament, locate the small hole behind the thread feed assembly. Push the mono-filament into this hole and up through the supply tube until the end extends above the cone of thread. Then, secure the end of the thread in the notch of the monofilament and slowly pull the thread through the tube.

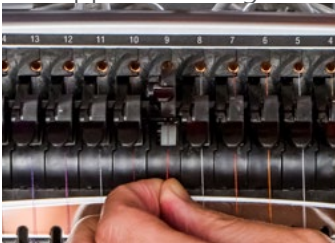


- If using compressed air, place the end of the thread in to the top of the thread supply tube. Feed enough that the thread will stay without holding it. Now blow the compressed air into the tube. The air will carry the thread and shoot out the front of the machine.

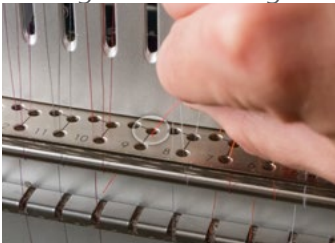
3. Using the black tab just in front, lift the pinch roller.



4. Pull the thread from the hole and place it under the pinch roller. Bring the thread down through the upper thread guide.



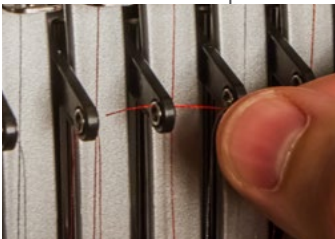
5. Pull the thread down to the middle thread guide. Of the three holes, push the thread from the top through the back right hole. Make sure the thread is on the right side of the take-up lever.



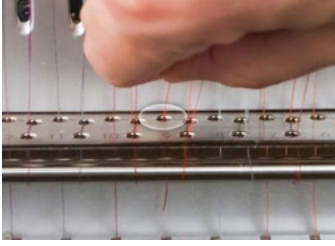
6. Bring the thread around the thread sensor from back to front and up through the front hole of the middle thread guide.



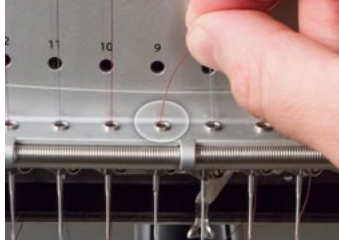
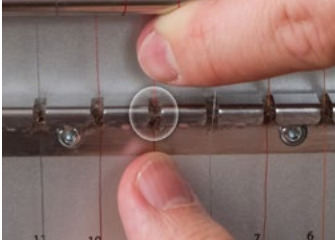
7. Pull the thread up and through the eye of the take-up lever from right to left.



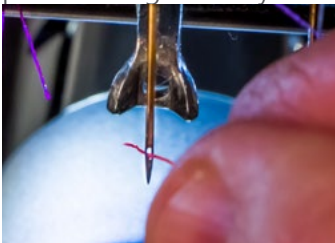
8. Route the thread straight down through the back left hole in the middle thread guide.



9. Press the thread into the felt restraint and feed it down through the lower thread guide.



10. Thread the needle from front to back. Cutting the end of the thread may allow it to more easily pass through the eye.

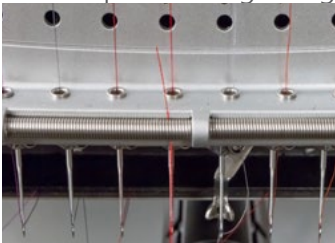


11. Be sure to align the thread with the small v-notch in the thread feed cover.



12. Press the black tab to lower the pinch roller.

13. If desired, the thread can then be held by the retaining spring in front of the lower thread guide or held in place using the grabber.

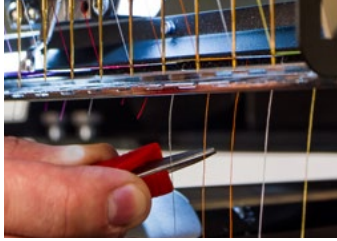


With your hands out of the way, press the adjustment and center keys on the keypad simultaneously to close the grabber and move the thread into the holder behind the needles.



Press the keys again to open the grabber.

14. Trim the end to about an inch in length



Bobbin Threading and Tensioning

The proper bobbin tension and installation also play an integral role in the quality and efficiency of an embroidery sewout.

What Type of Bobbin?

For the best results with your machine, use Style L continuous polyester filament bobbins.

Removing the Bobbin Case



CAUTION: Never attempt to remove or insert the bobbin while the machine is in operation.

The bobbin case can be removed from the lower arm of the machine by locating the release lever on the bobbin case.

Pull forward on this lever until the case is free from the machine.
Remove the old bobbin from the case.



Cleaning the Bobbin Case

It is recommended that you clean under the tension spring of your machine bobbin case every time you change the bobbin.

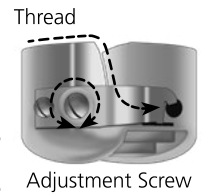
Lint and bobbin wax can build up under the spring, and this can affect bobbin tension. This, in turn, will have an impact on sew quality (loose bobbin, bobbin showing on front side of sew out, thread breaks, false thread breaks). To clean under the spring, slide a corner of a small piece of paper under the tension spring in the same direction the thread travels. While cleaning under the tension spring, be careful not to bend the spring.

After cleaning the bobbin case, blow the case out with compressed air. It is also recommended that you check the bobbin tension.



Inserting a New Bobbin in the Bobbin Case & Checking the Tension

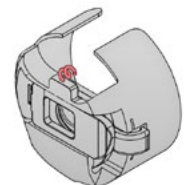
1. Hold the bobbin case with the front facing down and the open end facing up.
2. Hold the new bobbin with the thread coming over the top and to the right in a clockwise fashion. It should look like a number nine (9).
3. Without flipping the bobbin, drop it into the bobbin case.
4. Route the thread through the thin slot opening and under the tension spring. The bobbin thread should not be releasing from the side of the case.
5. To check the tension of the bobbin, hold the bobbin thread with one hand. As you gently bounce the thread, the bobbin case should barely drop. At most, it should drop a half inch / 13 mm. If the tension is incorrect, use a flat-blade screwdriver to turn the larger adjustment screw clockwise to tighten or counterclockwise to loosen the tension.



This test must be completed BEFORE winding the thread through the pigtail.

6. Once the tension is set, wind the thread through the pigtail.

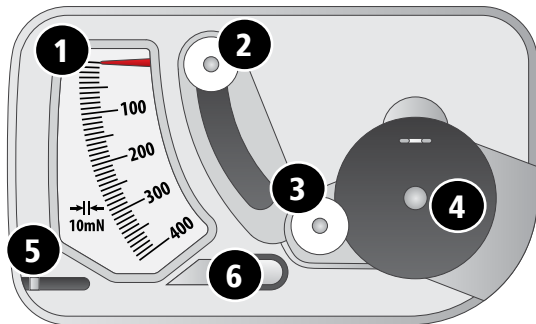
For a more accurate test of the bobbin tension, use a bobbin tension gauge.



Pigtail Shown in Red

Bobbin Case Tension Gauge

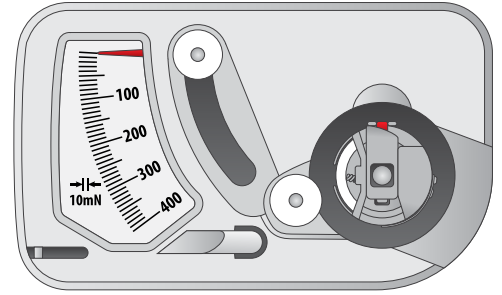
Overview



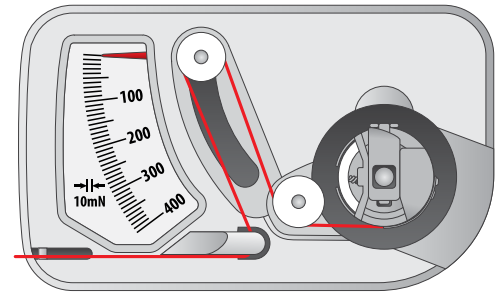
7. Indicator
8. Second Pulley
9. First Pulley
10. Bobbin Case Set Position
11. Thread Cutter
12. Thread Take-up

Using the Gauge

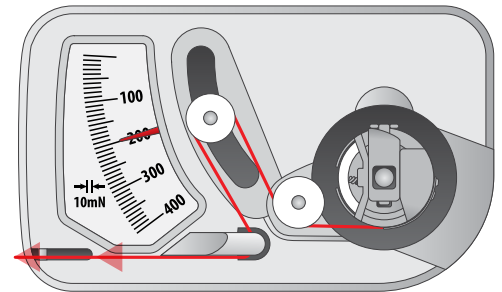
1. Clean and thread the bobbin case as you normally would.
2. Pull the thread through the tension spring, but do not pull the thread through the pigtail.
3. Insert the threaded bobbin case into the tension gauge with the extended portion of the latch falling into the guide as shown in red.
4. Route the thread through the two pulleys and the take up as shown in red.
5. Pull the thread gently and smoothly in the direction of the arrow at a rate of approximately an inch per second. Doing this will cause the second pulley to move down and with it, the gauge indicator. Watch as you pull for where the indicator is when the bobbin is starting to turn.
 - The ideal setting for bobbin tension for embroidery is between 180 and 220.
 - The necessary setting for bobbin tension during thread break sensor calibration is 250.



Step 3



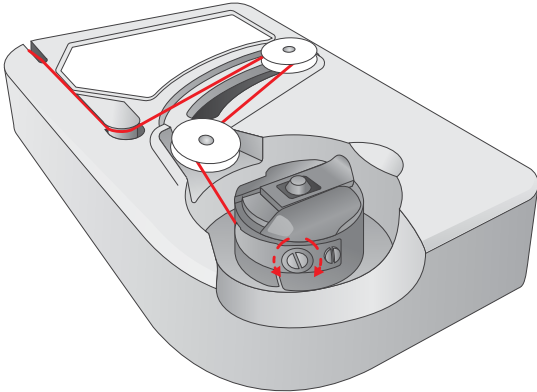
Step 4



Step 5

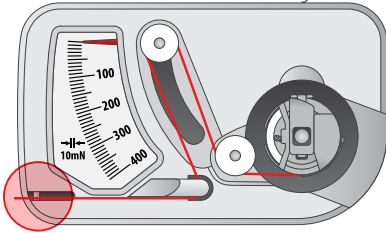
Adjusting Bobbin Tension


1. To adjust the tension, access the adjustment screw (larger of the two) on the tension spring from the recessed corner of the gauge.
2. Using a small flat blade screw driver, turn the adjustment screw in small increments between testing. Small rotations can make large adjustments to the tension.
 - Clockwise: This increases the tension on the bobbin thread.
 - Counter Clockwise: This decreases the tension on the bobbin thread.




Other Instructions

Note: Extra thread may be trimmed away using the thread cutter located below the indicator.



 *This device is a precise measuring apparatus that has been carefully tested and adjusted. Do not drop, hit against another body, or disassemble it.*

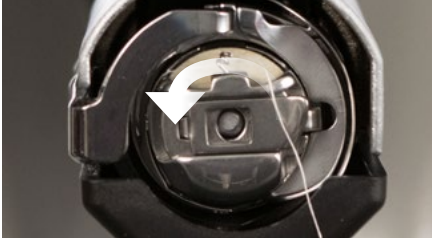
 *Avoid gauge contact with thinner oil, benzine oil, alcohol, and/or petroleum.*

Inserting the Bobbin Case



CAUTION: Never attempt to remove or insert the bobbin while the machine is in operation.

1. Insert the bobbin and case in the machine with the pigtail facing up. Push on the bobbin case until it snaps into place.
2. Test the bobbin orientation by pulling on the thread. The bobbin should rotate counter-clockwise.



3. Trim the thread to 2 - 3 inches.



NOTE: If the thread is cut too short, it will not pick up on the stitch. If the thread is left too long, it may wrap into the machine.

Initial Maintenance

The first time the machine is powered on, it is highly recommended that an initial maintenance be performed. To step through this maintenance,

It is recommended that you go through the first three maintenance sets when you first set up your machine. The maintenance procedures are covered in the maintenance section of this manual.

- 200,000 Stitch (Hook) Maintenance
- 2,000,000 Stitch Maintenance
- 10,000,000 Stitch Maintenance

Each section will walk you through the maintenance procedures and direct you to move the machine to the appropriate positions for each step.

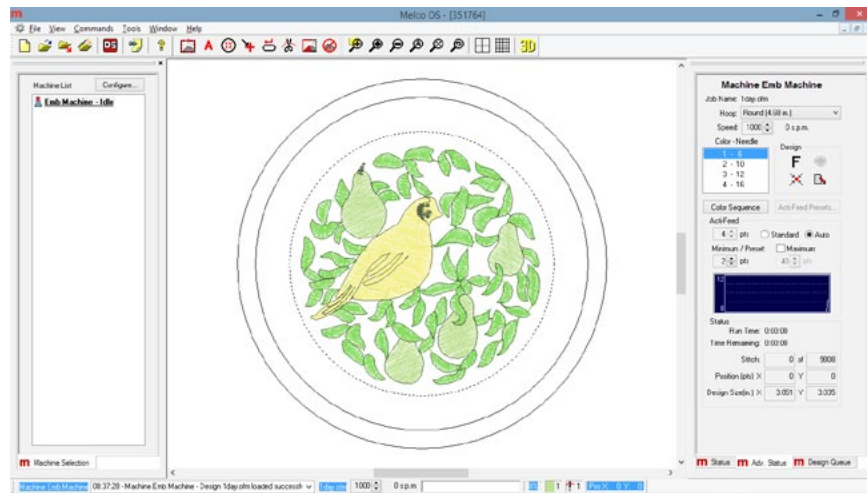
Melco OS Screen Overview

In the following sections, you will become more familiar with the operating software for your machine. The next sections will walk you through the loading of a design and how to set machine settings such as color sequence.

Screen Overview

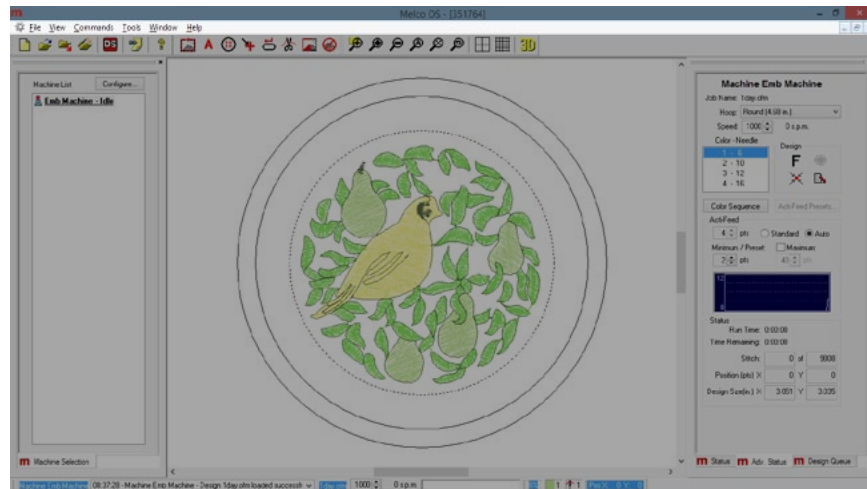
To view the Melco OS screen, the software must be open and the machine must be on and communicating with it. If you have not done so, launch the software and power up the machine.

When Melco OS is open and communicating with the machine, you will see a window similar to the one below. Some icons, windows, and tabs may not be visible depending on the level of software you are running.



Menu Bar

The menu bar lists drop-downs from which you can select any number of commands for the machine. Many of these commands will also be accessible from a keyboard shortcut or an icon on the toolbars.



Toolbars

Many of the machine commands are found on these bars. These bars can be moved by clicking and dragging on the small vertical line to the left of each set of icons. Each icon will display a tool tip when hovered over with a mouse. This will allow you to quickly see what each icon does.



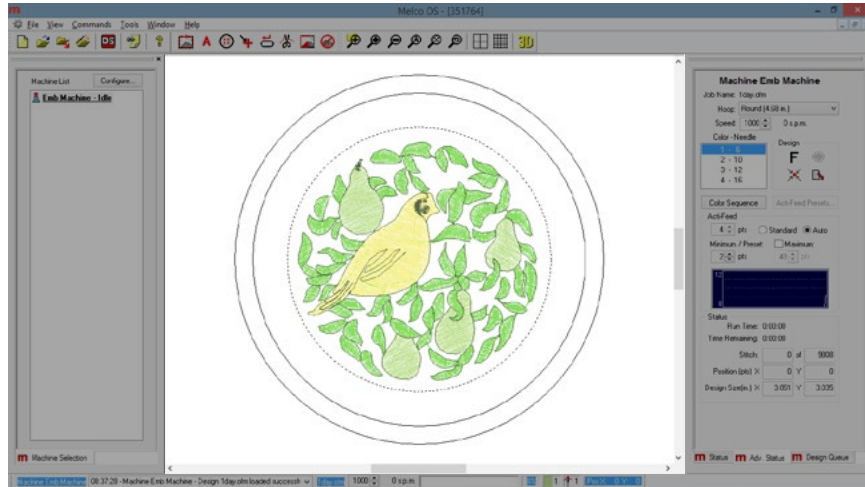
Machine List

This list of the machines connected to and communicating with Melco OS may or may not appear depending on the level of your software. This list is used to choose which machine or machines you wish to a design to or set settings for.



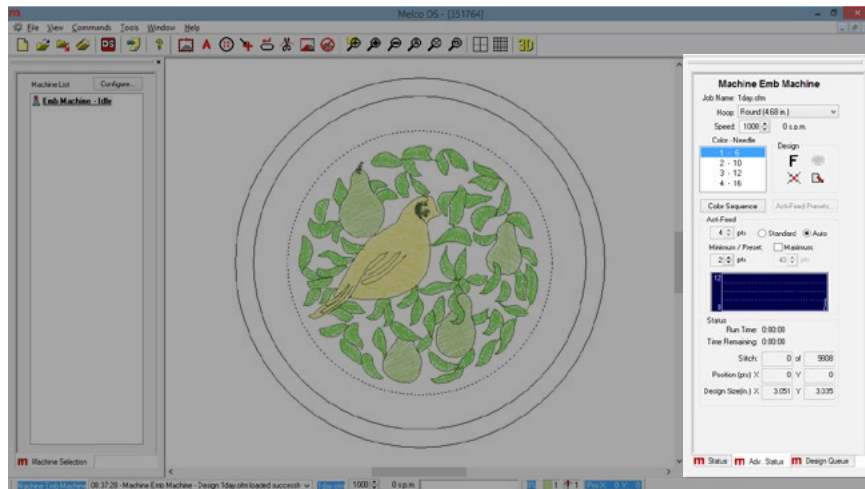
View Window

This area displays the design that is currently loaded to the machine as well as the currently selected hoop. This area is helpful in determining proper hoop size as well as embroidery location. This area may be blank if this is the first time the machine has been connected to the computer or if the machine has been switched off for a long time.



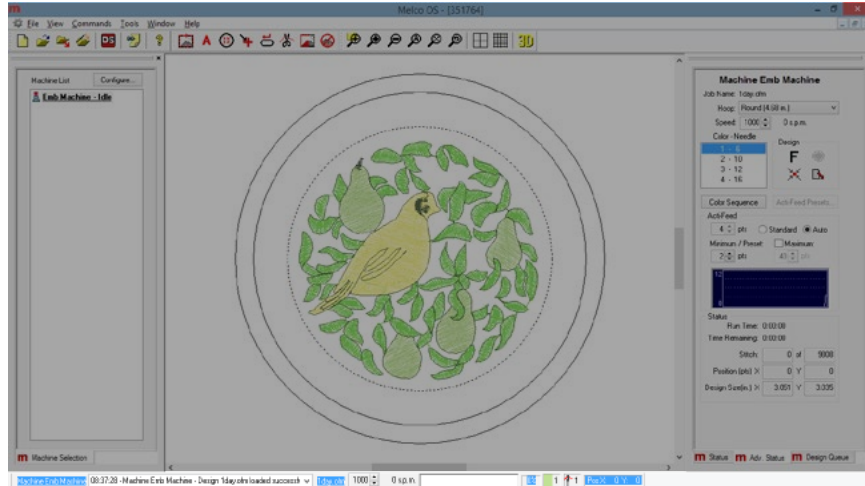
Status Tab

The status tab contains many of the sew settings for the machine. When preparing to run a design, it is common to address most of these settings before pressing the start button. These settings are explained in the next few topics.



Machine Bar

This bar, typically found at the bottom of the screen, displays the current status of a running machine. It will show a status log, sew speed, progress bar and percentage, as well as the current needle, color, and position.




Loading a Design

This section will walk you through loading a design to your machine. There are multiple ways to accomplish this, but for now, we will stick to the main two commands.

- Load Design
- Load Design Wizard

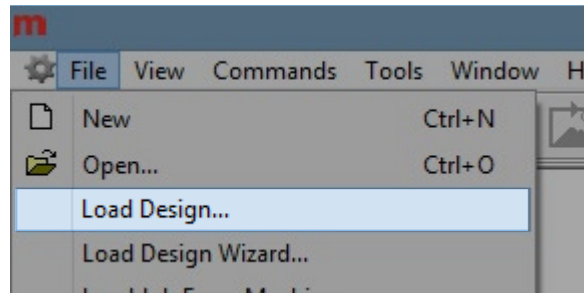
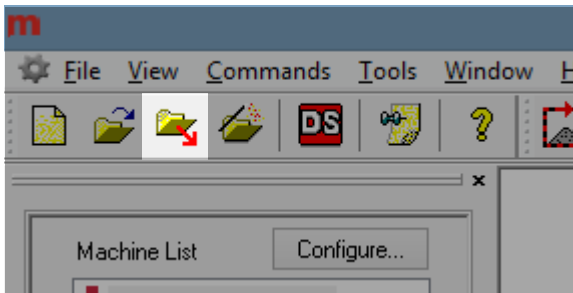
The Load Design command will simply load a design to the selected machine or machines. The Load Design Wizard will load the design to the selected machine, but it will also prompt you to set the color sequence, select the hoop, and set the Acti-feed.

 *When you are ready to load the next design, you do not need to delete the current design. You simply load a new design. It will replace the current one in the machine.*

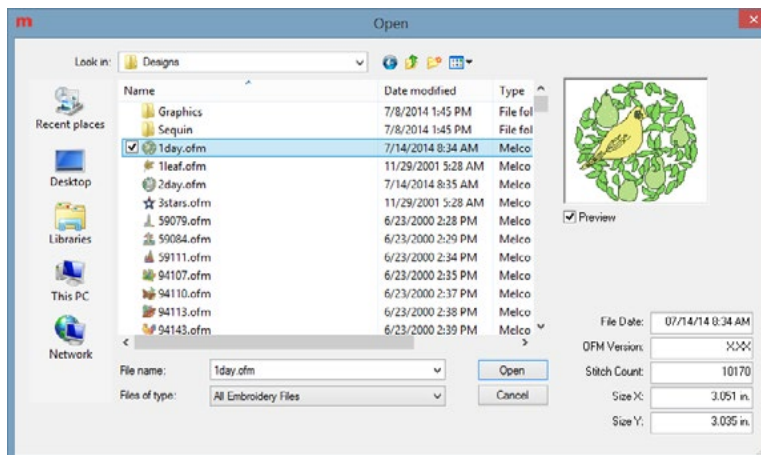
Load Design

To load a design using the Load Design command, you can use either the menu drop-down command or the icon on the toolbar.

1. Click on either the Load Design icon or choose File from the menu bar and select Load Design....



2. In the dialog box that opens, navigate to and select the design you want to load, then click Open. Double-clicking on the design from this window will also load it to the machine.



3. 1day.ofm is a good file to start with. It is most commonly located in the "Designs" folder on your local drive.

4. After a loading progress bar displays, the design will appear on screen and be loaded into your machine.

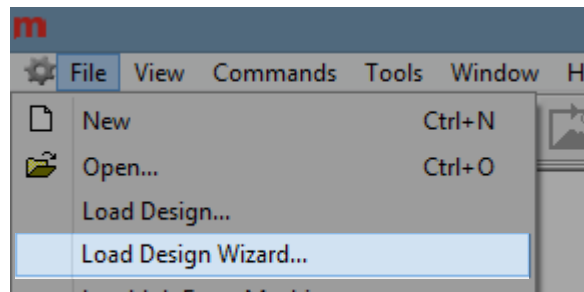
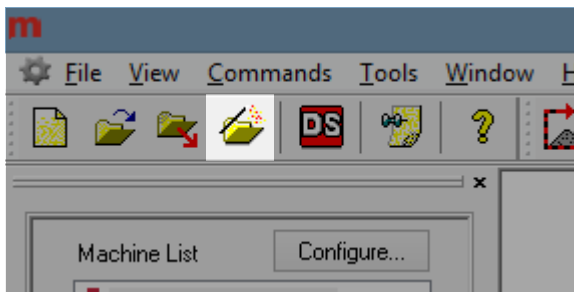


5. The design is loaded and you can progress to setting the color sequence.

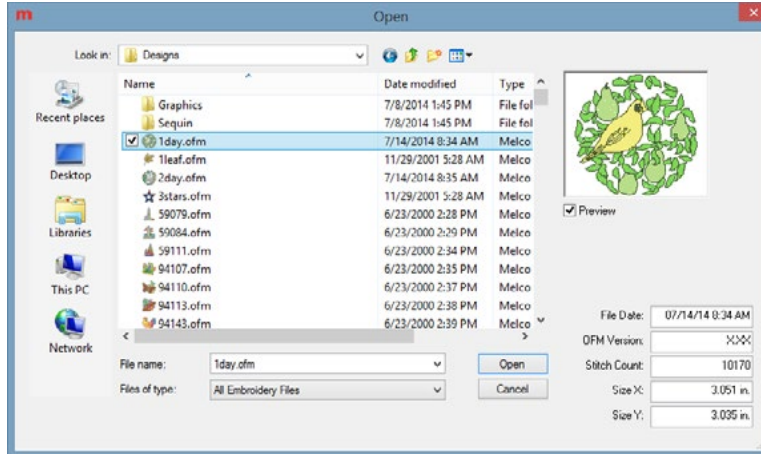
Load Design Wizard

To load a design using the Load Design Wizard, you can use either the menu drop-down command or the icon on the toolbar.

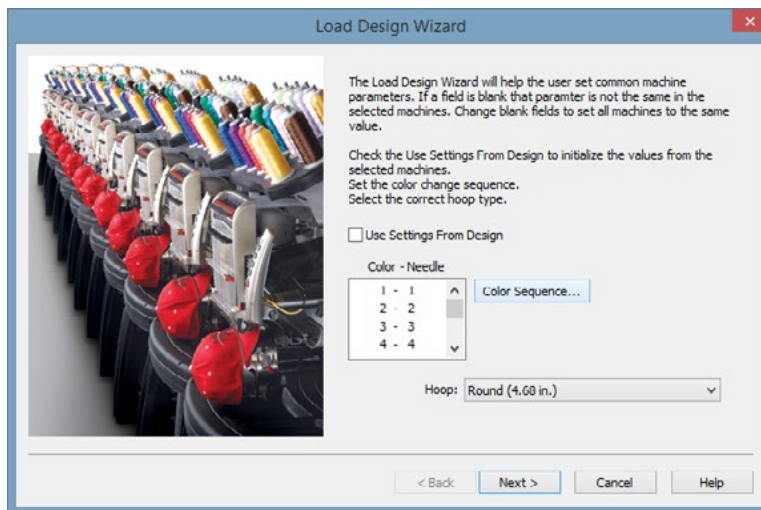
1. Click on either the Load Design Wizard icon or choose File from the menu bar and select Load Design Wizard....



2. In the dialog box that opens, navigate to and select the design you want to load, then click Open. Double-clicking on the design from this window will also load it to the machine.



3. 1day.ofm is a good file to start with. It is most commonly located in the "Designs" folder on your local drive.

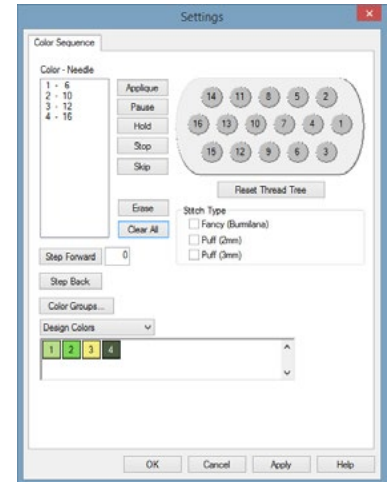


4. After a loading progress bar displays, the design will appear on screen and be loaded into your machine. The next window of the wizard will appear, and you can set the color sequence.
5. After setting the color sequence and choosing the hoop, click or tap the Next button to move on to selecting the sew speed and acti-feed settings. Each of this setting are explained in subsequent sections.
6. When finished, click or tap the Finish button to complete the process and close the Load Design Wizard.

Setting the Color Sequence

This section will walk you through setting the color sequence for the design. The color sequence can be accessed from a few places.

- Status or Advanced Status Tab:
 - Click on the Color Sequence button.
- Through the Load Design Wizard
 - From the first window after the design has loaded, click on the Color Sequence button.
- From the Tools menu:
 - Click on the Tools menu and select Settings....
 - Click on the Color Sequence tab.



Once accessed, the color sequence is set in mostly the same way.

To enter a new color sequence:

1. Click the Clear All button. This removes the color sequence from the previous design to sew. In the case of a new machine, this will remove the color sequence used for the test sew pattern.
2. Determine the needle order in which you would like to sew. This can be accomplished by using the design colors as a suggestion, or by using the Step Forward and Step Back buttons to determine the sew order of the elements in the design. Some designs, like many stock designs, may also come with a recommended color sequence. Step Forward and Step Back work only if the design is visible. Windows may need to be moved to see the design behind the settings window.



3. In the example above, the first recommended color is a light green. The second color is medium green. If you wanted to sew in those colors, find the light and medium green threads on the thread tree of your machine. The position of the cones of thread on the machine correlates to the positions on thread cone display in the software.



4. Click on the cone number (needle number) in the thread cone display in the order you wish to sew. If the light green was on needle 4 in the example above, you would click on the circled 4 first. This would place a "1-16" in the Color-Needle field on the left. This indicates that color 1 will sew on needle 4.
5. Continue in the same fashion for the rest of the color blocks in the design.

To change a color in the existing color sequence:

1. Determine which color number in the color sequence you want to change.
2. Double-click that color, and it will begin to flash. Now you may choose a new needle for that color. In the thread cone display, click on the needle number (cone number) that holds (or will be holding) the thread you want to sew for that color number. This will replace the current needle with the new needle.

To add a color to the existing color sequence:

If you missed a color and need to go back and add it, you can do so in the Color - Needle box.

1. Click on the color you want to add. If you were missing color 2, that is the color on which you would click.
2. Once the color is highlighted, click on the desired thread cone number (needle number) in the thread cone display. This will insert the new needle number for that color and shift down all of the following colors in the sequence.

To remove a color from the existing color sequence:

1. Select the color you wish to remove from the Color - Needle box.
2. Once the color is highlighted in that box, click on the Erase button.
3. The remaining colors in the sequence will be shifted up.

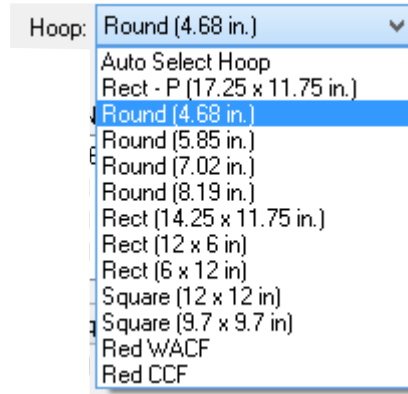
Additional Settings

Additional commands and settings are available under the Color Sequence Tab. The section of this document

Selecting a Hoop in the Software

To select a hoop in Melco OS:

1. Click on the Hoop Selection drop-down to show the available hoop sizes.
2. Click on the hoop you want to select. The new hoop will appear in the View Window.




3. If using the load design wizard, you will need to click Next > to continue to the next screen with Machine Speed and Acti-feed.

Choosing the Appropriate Hoop Size

The Melco OS view window will show how the current design will fit into the selected hoop. Ideally, the hoop used to embroider a design fits as closely as possible without the design exceeding the hoop limits. This will help prevent excess material from pulling and moving in the hoop while being sewn.

If the load design wizard is used, the hoop selection can be changed after exiting the wizard in order to see the change in hoop size on screen.

 *For your first sew out, the 12cm (4.68 in.) hoop or the 15cm (5.85 in.) round hoop should work well for the 1day.ofm design.*

For more information on choosing an appropriate hoop, see the Choosing the Right Hoop section.

Customize Hoop List

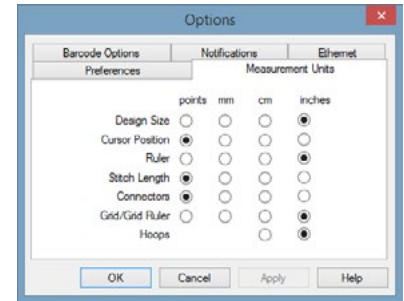
The hoop list drop-down can be customized to contain only the hoops that you own. To access this feature:

1. Click on the Tools menu.
2. Select Hoop Setup.
3. Click on the Customize Hoop List button. This will bring up a window from which you can choose which hoops will be in the hoop selection drop-down in the machine views.
4. Place check marks by any hoops you own or wish to be in the list, and uncheck any hoops that you do not.
5. When finished, click OK.

Inches or Centimeters

The measurement units for the hoops and many other aspects of Melco OS can be changed.

1. Click on the Tools menu.
2. Select Options.
3. Click on the Measurement Units tab.
4. Select your desired measurement units.
5. Click OK.

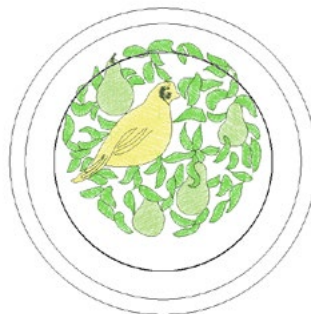



Hoop Limits

The dotted line represents the maximum sewing field, the outer solid line represents the outer edge of the inner hoop, and the inner solid line represents the inner edge of the inner hoop. Software hoop limits are drawn as a black dotted line drawn within the hoop. Software hoop limits for the sequin device are drawn as a black dash-dot-dot line within the hoop when a sequin design is loaded to the machine. Machine hoop limits are drawn as a light gray dash-dot line in hoops where machine hoop limits differ from the software hoop limits.



If the hoop you have selected is too small for your design, you will be able to see this in the Melco OS window. If the design crosses the dotted line, the dotted line will become a thicker solid black line indicating that the design falls outside of the recommended sewing area. This could mean that the design is too large for the hoop or simply needs to be moved to an area in the hoop that can accommodate it. If the hoop limit is exceeded and a trace command is attempted or the start button is pressed, a message window will pop up stating that "Machine ##### - Machine unable to start, hoop limits exceeded."



 *Note: If the design is being viewed in 3D, the hoop limits will not change to solid black when they have been exceeded. They will still prevent the machine from sewing or tracing if they have been exceeded.*

If the sequin hoop limit is exceeded when a sequin design is loaded a banner will display informing the user of potential for collision.

Centering the Hoop

If the hoop is not centered on the machine, it may be centered using either:

- The Center Hoop icon in Melco OS



- The Hoop and Center keys on the machine keypad.



Setting the Sew Speed

This section will walk you through sew speed for your machine. This can either be done from:

- Machine Keypad
- Software Controls

i *If the software level prevents you from using the software controls, you will need to use the machine Keypad to change the sew speed.*

How Fast Should I Sew?

The machines have extremely fast sew speeds. These speeds may need to be changed depending on the products or designs you're planning to embroider.

When the machines start to sew, they will begin slowly and then rapidly speed up after the thread has had a few stitches to catch.

The machine will sew at the set sew speed if it is possible. However, design factors may cause the machine to slow down. Longer machine movements and stitches will cause this. If you hear the machine changing speeds constantly, you may want to lower the set sew speed to even out sew quality.

Sew Speed	Application
850-1000 s.p.m.	Sewing using the Wide Angle Driver used for caps and micro (pocket) clamps. Designs using metallic or specialty threads.
1000-1200 s.p.m.	Finer detailed designs, smaller lettering.
1200-1500 s.p.m.	Faster production.

These sew speeds are meant as guidelines and should be adjusted as needed.

Sew Speed Change from the Machine Keypad

To set the sew speed from the keypad of the machine:

1. Press the Hoop and Up or Down Arrows simultaneously.
 - Pressing up will increase speed by 50 s.p.m.



- Pressing Down will decrease speed by 50 s.p.m.



Setting Sew Speed in Melco OS

To adjust the sew speed setting in Melco OS:

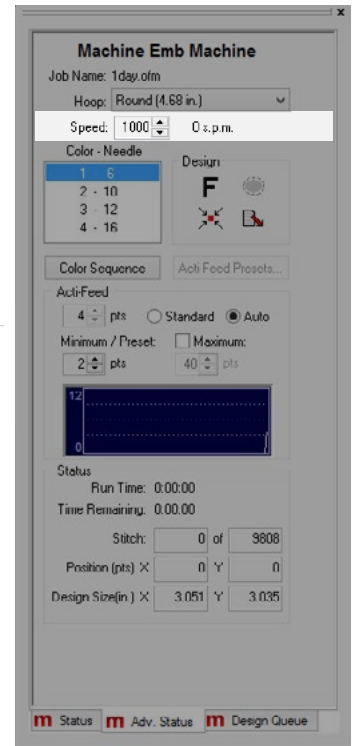
1. Click on either the up or down arrow just to the right of the speed setting.
 - Pressing up will increase speed by 50 s.p.m.
 - Clicking down will decrease speed by 50 s.p.m.

Symptoms from Sewing too Fast

Sewing with too high of speed can result in a few undesirable outcomes. These would include:

- Thread breaks
- Bobbin pulling to the top
- Poor registration of designs (designs don't line up)

These symptoms can also be caused by other settings or applications. However, if you experience one or more of these symptoms, adjusting your sew speed could be a possible solution.



Acti-Feed

Acti-feed is the feature that replaces the tensioning system on a conventional embroidery machine. It uses thread feed gears, rollers, and a thread sensor bar to feed the appropriate amount of thread for each stitch.

Acti-Feed is the system that calculates and feeds the correct amount of thread per stitch during sewing. The amount of thread feed per stitch is dependent on material thickness.

This section will walk you through Acti-Feed settings. Acti-Feed has two modes that can be changed by clicking on the radio button to the left of the desired mode.

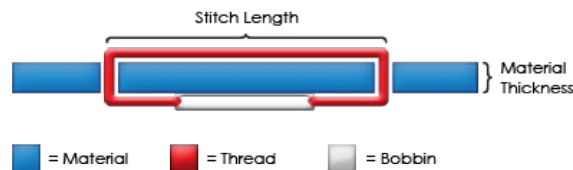
- Standard
- Auto

 For the initial design, auto should work well.

Material Thickness

Material thickness is a determining factor in the amount of thread feed for each stitch. It is displayed under "Acti-Feed" in the Status Tab and the Advanced Status Tab. It can also be found in the Thread Feed Tab.

Material thickness is measured in points. Points are a very fine unit of measure found in the embroidery industry and represent a tenth of a millimeter.



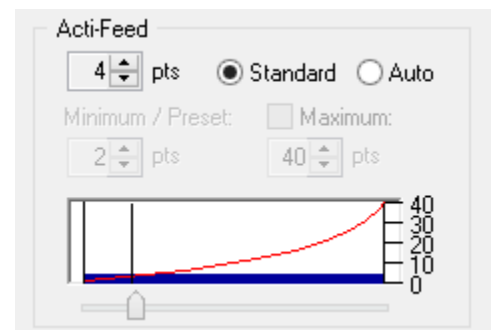
In general, as material to be embroidered increases in thickness, the value for the material thickness should be higher to increase thread feed.

Standard Acti-Feed

Standard Acti-feed is used to feed thread at a user specified amount. It will not feed more or less thread than the amount specified.

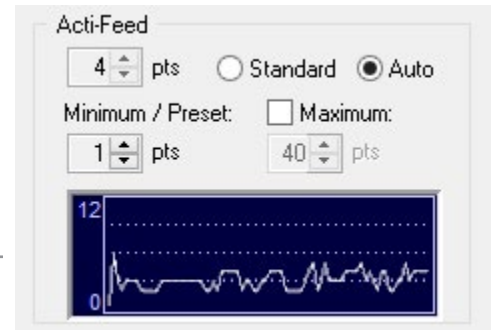
The amount can be adjusted by clicking on the up or down arrows to the right of the number. The number represents the material thickness.

The default value for the material thickness field is 4 points, but if running in standard acti-feed mode, you will need to adjust it to match your material. It can be adjusted to values ranging from 0-40 points.



Auto Acti-Feed

Auto Acti-feed is used to feed thread based on feedback from the thread sensor bar. This allows auto acti-feed to change the material thickness number as it is sewing to reflect changes in the material. This mode is ideal for any material or application that changes thickness. For example, it would be good to use for caps with seams or jackets with appliqué.



i *While auto mode was designed for materials that change thickness, it works well with most materials. It is recommended for your first sew-outs.*

As the product being embroidered changes thickness, the thread dynamic changes and is reflected by the sensor. The sensor sends information back to the software, and the material thickness number is automatically adjusted.

The changes in the material thickness are depicted in the moving graph just below the settings in the advanced tab.

i **NOTE:** *Bobbin tension should be set to drop 1-2" when bounced when using Acti-Feed Auto Mode.*

Limits for Auto Acti-Feed

Auto acti-feed automatically adjusts for different garment thicknesses. You can however provide some guidance in the form of lower limits. This will provide a range in which auto acti-feed must operate. Information on these limits can be found in the Acti-Feed Limits section.

While typically used with thicker materials, the lower limit (Minimum/Preset) is helpful when dealing with more delicate or squishy materials. It is helpful were the thread could pull tight, but a little more loft is desired.

Finding the Right Settings

Finding just the right settings or limits for your acti-feed is not always necessary, but it can make a marked improvement in sew quality and machine performance. See details in the following sections.

Auto Acti-Feed Limits

Auto acti-feed automatically adjusts for different garment thicknesses. You can however provide some guidance in the form of autofeed limits. This will provide a range in which auto acti-feed must operate.

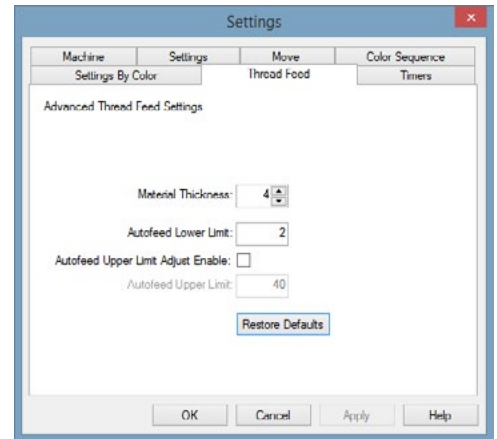
Autofeed Lower Limit (Minimum)

The autofeed lower limit guides auto mode with a minimum thread feed. It allows auto mode to adjust and feed more thread as needed, but it will not allow feeding less than the specified amount. The exception to this limit is the last few stitches before a trim. They will be allowed to feed less thread and essentially create a tighter tie stitch.

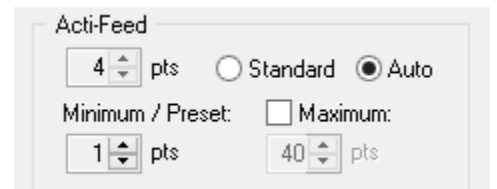
The lower limit is helpful when dealing with more delicate or squishy materials. It is helpful were the thread could pull tight, but a little more loft is desired.

The autofeed lower limit can be accessed through the Thread Feed Tab or through the Advanced Status Tab (if available) of the main Melco OS screen. To access the lower limit:

1. Select Tools from the menu bar.
2. Click on Settings.
3. Select the Thread Feed Tab



The same information can be accessed from the Advanced Status Tab if available in the main Melco OS screen. The autofeed lower limit is shown as the "Minimum".



Autofeed Lower Limit Suggestions

The autofeed lower limit is used to provide guidelines for auto act-feed mode. The following settings are suggestions of settings that might be used to better accommodate different fabrics and the backings. These settings may need to be adjusted as material weights differ across the variety of garments on the market.

Material	Lower Limit
Broadcloth with cut-away backing	3
T-shirt with cut-away backing	4
Polo shirt with cut-away backing	5
Towel with tear-away backing	8
Unstructured cap with tear-away backing	4-5
Structured cap with tear-away backing	6-7

Autofeed Upper Limit (Maximum)

The autofeed upper limit is a seldom used, but occasionally handy feature. It is not available on all packages of the machine. If it is unavailable, the machine maximum of 40 points is used.

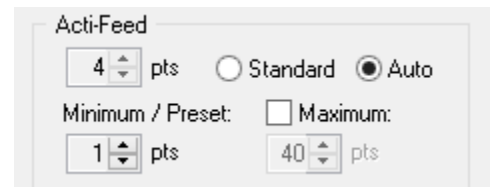
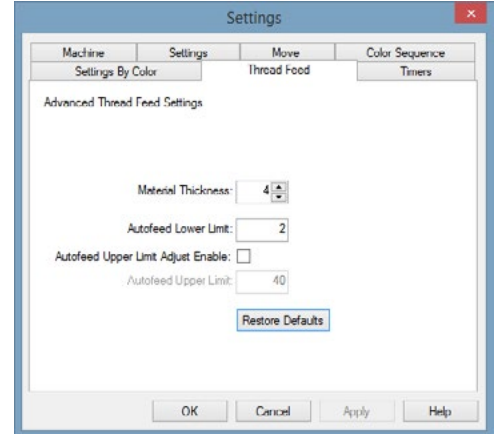
The autofeed upper limit restricts auto mode with a maximum thread feed. It allows auto mode to adjust and feed less thread as needed, but it will not allow feeding more than the specified amount.

The autofeed upper limit is disabled by default and will use the machine maximum of 40 points unless the check box enabling the feature is checked.

The autofeed upper limit can be accessed through the Thread Feed Tab or through the Advanced Status Tab (if available) of the main Melco OS screen. To access the upper limit:

1. Select Tools from the menu bar.
2. Click on Settings.
3. Select the Thread Feed Tab

The same information can be accessed from the Advanced Status Tab if available in the main Melco OS screen. The autofeed upper limit is shown as the "Maximum".



Appropriate Material Thickness Settings

Finding just the right settings or limits for your acti-feed is not always necessary, but it can make a marked improvement in sew quality and machine performance.

Sew quality and thread breaks are indicators of appropriate or inappropriate thread feed. Those symptoms are listed in sections below. The material thickness setting can either be adjusted in standard mode, or preferably, the lower limit could be adjusted in auto mode.

Material Thickness Value is Adequate When...

The material thickness does not need to be adjusted when:

- Satin and fill stitches - There is no looping or pulling on the top of a sew-out when sewing satin and fill stitches.
- Satin stitches - On the back side of the sewout, you can see 1/3 of bobbin showing in the middle of columns and the top color for the remainder around the sides.
- Fill Stitches - On the back of the sew-out, the top thread is even along the edge.

Increase Material Thickness When...

When not enough thread is being fed into the design, you need to increase the material thickness value. If you experience any of the following problems, you may need to perform this adjustment.

- Satin stitches - You are encountering thread breaks and you can see bobbin thread on the top of the design.
- Satin stitches - Too much bobbin is showing on the back of the design.
- Fill stitches - You can see bobbin thread on the top of the design.
- Fill stitches - There is not enough top thread showing on the back of the design.
- Registration Loss - If designs are not lining up when sewn and the cause is the thread being pulled way too tight, increasing the Material Thickness may help. Using a stable backing will also help.

Decrease Material Thickness When...

When too much thread is being fed into the design, you need to decrease the material thickness value. If you experience any of the following problems, you may need to perform this adjustment.

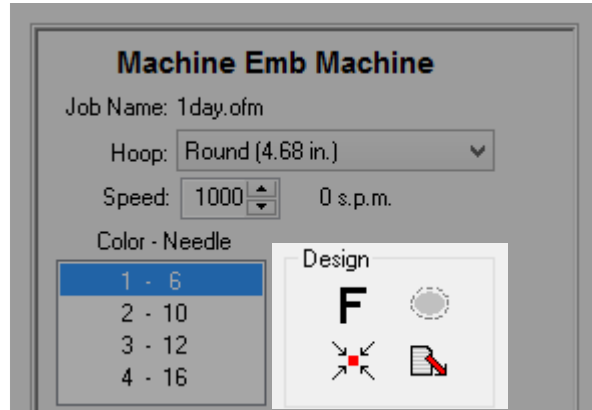
- Satin stitches - The stitches in the design are looping.
- Satin stitches - Not enough bobbin is showing on the back of the design.
- Fill stitches - You are encountering thread breaks and the stitches in the design are looping.
- False Bobbin Breaks - When the software detects bobbin breaks that are not really breaks, it could be that your material thickness is too high.

Design Orientation or Rotation

This section will walk you through changing the orientation of the loaded design.


To change the orientation of the design:

1. Click on the Design Orientation F



Every click on the orientation F will rotate the icon by 90°. When the clicking stops, the design will rotate and the F icon will reset. The icon does not show the orientation of the design. It shows the changes you are making.

After four clicks of the F, the design will reflect and become a mirror image of the original.


 *If using 1day.ofm for your initial sew-out, changing the orientation is not necessary.*

When Should I Rotate My Design?

Some products like blankets, towels, caps, or hooded sweatshirts will embroidery more easily when hooped so that the design would be sewn upside-down. When these situations arise, it is often very beneficial to rotate your design.

Choosing the Right Hoop

Hooping a garment properly and selecting the right hoop for the job is essential to quality embroidery production. The hoop provides the means to move the product at high speeds and accurately place the stitch. If the hoop is too loose, the wrong size, or if the product is hooped poorly, this can adversely affect the design.

 *For the first sew out, the 12cm (4.68 in.) hoop or the 15cm (5.85 in.) round hoop should work well for the 1day.ofm design.*

Choosing the Appropriate Hoop Shape

To start, we need to know what type of hoop to use. Each shape has benefits and drawbacks.

Hoop Shape	Benefit	Drawback
Traditional Round	Even tension across the fabric. Great hoop for most left-chest designs.	Limited size number of sizes.
Traditional Square	Larger sew fields.	Tension is tighter in the corners and looser on the edges.
Specialty (clamps and other frames)	Tend to be easier to hoop quickly. Better for difficult to hoop materials and/or placements.	Does not hold the material as securely as a traditional style hoop.

Choosing the Appropriate Hoop Size

The ideal hoop for an embroidery design is one that just fits. The design would fall just inside the hoop limits.

Why would this matter? It removes the influence of excess material from around the design. This can help with registration (lining up), puckering, and overall stitch quality.

Occasionally there will be obstacles to using the smallest hoop possible for a design. It could be that a button is in the way, or a seam would fall right into the hoop. Adjusting your hoop size to better accommodate the material may be necessary.

Plastic or Wood?

Some of the larger hoops come in either wood or plastic. The wooden hoops are double walled and have more grip than the plastic. However, the inner and outer wooden hoop must remain aligned. The outer hoop cannot be rotated for easier hooping or tightening. Each set of hoops will have a registration number printed on both hoops to help keep them aligned.

Specialty Hoops

Specialty hoops such as clamps and frames that use adhesives are useful when dealing with difficult placements on garments or materials that are hard to hoop.

As they rarely provide the same hold on the materials as a traditional hoop, these hoops tend to be reserved for more specialized applications

Hooping

Hooping the fabric or garment securely is important to the quality of the embroidery. This section will walk you through the adjustment of the hoop tension as well as the hooping process.

Adjusting the Hoop Tension

You will need to adjust the tension of the hoop any time you change to a drastically different material. For example, changing from a T-shirt to a sweatshirt would require a change in hoop tension.

1. Start with a clean flat working surface. Remove clutter from the area. Do not hoop on an uneven surface or stack of shirts.
2. Use an appropriate hoop for your design. For more information, read the section on choosing an appropriate hoop.
3. Loosen the tension on the outer hoop ring by turning the adjustment screw counter-clockwise.

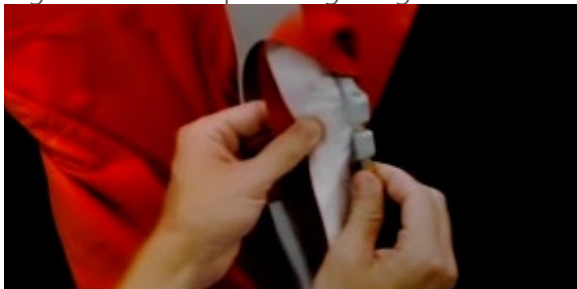


4. Place the outer hoop ring inside the garment.
5. Slide the appropriate backing between the outer ring and the hoop.
6. Smooth the fabric over the hoop.
7. Gently align the inner hoop with the outer hoop, sandwiching the backing and a single layer of the garment. The mounting brackets should be facing up.
8. Press the hoop down and into place. It should go fairly easily. Take care to press on the ring rather than on the arms.



Pressing on the arms can bend the hoop out of shape or break it.

9. Reach inside the garment and tighten the outer hoop by turning the adjustment screw clockwise. Tighten the hoop to finger-tight.



10. Now, without loosening the screw, remove the hoop from the garment.
11. Tighten the adjustment screw a turn or two more.
12. The outer hoop is now adjusted.

The appropriate tightness of a hoop can be tested by tapping rapidly with moderate pressure on the fabric inside the hoop. By doing this, you can mimic the presser foot of the machine. If material walks into the hoop, the hoop is too loose and needs further adjustment.

Hooping the Garment or Fabric

With the hoop properly adjusted, the garment can be hooped.

1. Start with a clean flat working surface. Remove clutter from the area. Do not hoop on an uneven surface or stack of shirts.
2. Use an appropriate hoop for your design. For more information, read the section on choosing an appropriate hoop.
3. Place the properly tensioned outer hoop ring inside the garment.
4. Slide the appropriate backing between the outer ring and the hoop.
5. Smooth the fabric over the hoop.



6. Gently align the inner hoop with the outer hoop, sandwiching the backing and a single layer of the garment. The mounting brackets should be facing up. The notch in the mounting bracket will face the machine when the hoop is loaded onto the machine.
7. Using the hoop arms as a guide, make sure that the hoop is level to the garment. This will help prevent sewing a design crookedly on a product.



8. Press the hoop down and into place. Take care to press on the ring rather than on the arms. Pressing on the arms can bend the hoop out of shape or break it.

melco

- It may be helpful to start by placing one hand just below and off of the outer hoop to stabilize and smooth the fabric.
- Try to hoop in a smooth motion. If the hoop rocks back and forth, extra material will move into the hoop and diminish the quality of the embroidery.
- Do not overstretch the material. Stretching the material will stretch and distort the sew-out. It can also lead to puckering.



9. Once the material has been hooped, make sure that the garment is smooth, flat, and taut. If the garment is loose, you may need to remove the hoop and adjust the hoop tension or hooping method.



10. Check the back of the hooped piece. Make sure that there are not wrinkles or other parts of the garment lodged in the hoop.
11. As a final step, check the hoop for placement accuracy and straightness.

Hooping Tips

Round hoops give the most even tension of all the hoop shapes.

Wooden hoops will have registration marks on them. These help maintain the shape and hold of the hoop.

Many wooden hoops are double-high, meaning their sides are twice as tall as normal hoops. They help grip slick or bulky goods because of the larger surface area and slight tooth the wood provides.

Choose the smallest hoop that the design will fit in without going over the hoop limitations.

Adjust the hoop tension before hooping the final garment. If you adjust the tension of the hoop while the garment is in it, you will increase your chances of "hoop burn" and create ripples in the garment.

Sew a Swatch!

It is often a good idea to sew a practice piece on material as similar to the final product as possible. Although not essential, producing a sample is an excellent way to prevent or solve potential problems before embroidering the final product.

Working With Different Fabrics

Different fabrics and fabric weights may require you to loosen or tighten the hoop. It might take a few attempts to get the exact setting for the fabric you are working with. Most fabrics do not require the hoop to be tightened down once in the hoop.

Attaching or Moving the Hoop Support Arms

Depending on the hoop you plan on using, the hoop support arms on the machine will need to be in the inner position, outer position, or removed completely if using a clamp or the wide angle driver.

This section will walk you through attaching and removing the support arms properly as well as adjusting the spring clips.

Attaching the Hoop Support Arms

Determine which support arm position the chosen hoop requires. Most of the smaller hoops require the inner position. Most of the larger hoops require the outer position.

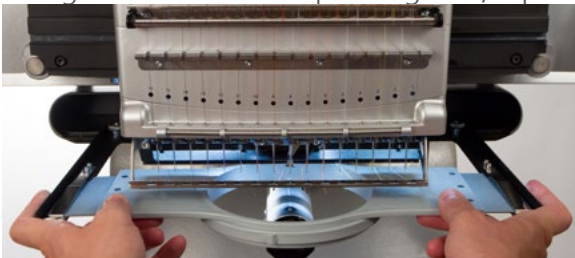
1. Align the hoop arms to either the inner holes or the outer holes on the x-carriage. There will be two holes for each support arm.
2. Make sure the clips on the ends where the tubular frame will attach are facing up. The sides of the hoop arms should face outward. This will ensure the brackets are attached to the correct side of the carriage. Also make sure both clips are attached securely to the arms.
3. Insert two thumbscrews for each arm. Screw them in to almost finger tight.



4. Install a hoop by sliding the side brackets of the hoop underneath the spring clips on the support arms. Slide the hoop towards the rear of the machine until it snaps into place and the brackets are fully seated beneath the spring clips. Make sure that the slotted bracket is to the right as you are facing the machine. The support arms will still move a little.



5. Using the installed hoop as a guide, square up the support arms.



6. Tighten the thumb screws to finger tight.
7. Using a 6mm hex wrench, tighten the screws a quarter to half turn more. Do not overtighten as the screws are designed to snap before damage to the x-carriage can occur.



If the hoop brackets shift forward and back, the spring clip may need to be adjusted. See the information below.

Removing the Hoop Support Arms

1. Use a 6mm hex wrench to loosen each of the two thumb screws attaching each arm to the x-carriage.
2. Using your fingers, fully loosen the thumb screws.
3. Remove the support arms from the x-carriage.

Adjusting the Spring Clips

When you have a hoop installed, you should make sure both spring clips are attached securely to the arms. If either side of the hoop can move front to back underneath the clip, the clip needs to be adjusted. It may be necessary to move the hoop forward for easier access to the nuts holding the clips. To adjust the clip:

1. Use a 5mm Hex nut driver to loosen the two nuts holding the clip in place.
2. Push the block underneath the clip as far forward as it will go.



3. Hold the block in place while tightening the nuts.

Loading a Hoop onto the Machine

1. Install a hoop by sliding the side brackets of the hoop underneath the spring clips on the support arms. Make sure that the slotted bracket is to the right as you are facing the machine.



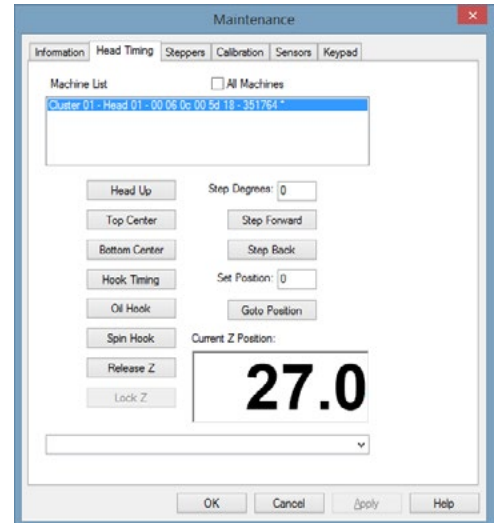
2. Slide the hoop towards the rear of the machine until it snaps into place and the brackets are fully seated beneath the spring clips.
3. Pull back gently on the hoop arms to ensure the spring clips are engaged.
4. Run your fingers around the edges of the hoop to ensure that sleeves, collars, zippers or other garment parts are not inadvertently under the hoop. Balloon the garment out around the cylindrical lower arm. This will prevent other garment parts from becoming sewn into the underneath side of the embroidery.



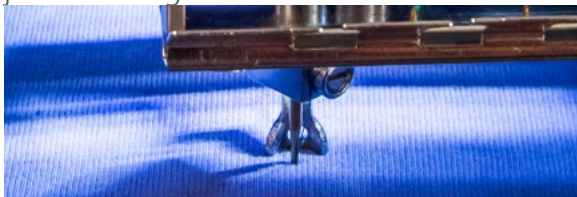
Adjusting the Presser Foot

The machine has an adjustable presser foot that can be set from 0.5mm to 3.5mm above the needle plate. The presser foot height should be changed when the thickness of the material you are sewing changes dramatically. To adjust the presser foot height, the software must be open, and your machine must be on and communicating with it. A hoop with the fabric you will be using should be installed.

1. Adjusting the presser foot is easiest with the needle case moved to needle 16. It is not necessary, but it makes the adjustment gear easier to see. If the machine is not on needle #16, the gear can still be accessed. Do not attempt to move the needle case during the following steps.
2. In the software, go to Tools>Maintenance>Head Timing Tab.
3. Make sure that only the material is under the needle, for the next step will command the machine to lower the needle.
4. In the Head Timing Tab, click or tap the Bottom Center button.
5. Locate the presser foot eccentric (gear) behind the needle case.



6. Turn the gear with your fingers to adjust the presser foot height up or down as needed.
7. Set the presser foot height over an unsewn section of the fabric. Set the presser foot so that it is just touching the material.



8. Once adjusted, press the raise presser foot button in the software.

Setting the Presser Foot for Different Materials

The presser foot will need to be adjusted whenever you drastically change the thickness of material that you are sewing on. For example, if you sew a sweatshirt and then sew a T-shirt, the presser foot would need to be adjusted.

The presser foot is meant to stabilize the material as the needle moves down through it and then help keep the material off of the needle as the needle moves back up. Ideally, the presser foot would sit just on the surface of the material, but that setting may not work for all material types.

For squishy materials like fleece or terry cloth, it is often better to lower the foot a bit more and press into the material.

Symptoms of Poor Presser Foot Height

Having the presser foot set poorly can result in a few sewing issues.


Presser Foot Height	Symptom
Too High	<ul style="list-style-type: none">• Thread breaks• Poor registration
Too Low	<ul style="list-style-type: none">• Louder sewing• Faint lighter halo around designs or dark fabric (Usually removed with steam, water, or a light ironing aid)

Keypad Operations

The machine keypad controls not only the starting and stopping of the machine, but it also provides access to change hoop position, sew speed, as well as the active needle. Many of these functions require the pressing of just a single button. Other functions require pressing multiple buttons simultaneously.



One Touch Controls

-
- | | |
|---|---|
|  | <p>Start</p> <p>Press to start sewing. Machine will not start if hoop limits have been exceeded.</p> |
|  | <p>Stop</p> <p>Press to stop sewing</p> |
|  | <p>Emergency Stop (E-Stop)</p> <p>Press this emergency stop button to stop immediately and cut power to the motors of the machine. Turn the knob clockwise to release.</p> |
|  | <p>Frame Back</p> <p>Move backward through a design one stitch at a time without stitching. Hold to move. Release to stop.</p> <p>After 15 stitches, machine will speed up. Press the stop button to stop.</p> |
|  | <p>Frame Forward</p> <p>Move forward through a design one stitch at a time without stitching. Hold to move. Release to stop.</p> <p>After 15 stitches, machine will speed up. Press the stop button to stop.</p> |
|  | <p>Laser</p> <p>Press to illuminate the point directly below the active needle.</p> |
|  | <p>Center</p> <p>Press for 1 second to change the focus of the OS to this machine. This only matters when multiple machines are present. It will also flash the serial number of the machine on screen.</p> |
-

Key Combinations

Center Hoop



Hoop + Center: Centers the currently selected hoop on the machine.

Move Hoop



Hoop + Up Arrow: Moves the hoop so the needle will sew higher in the hoop.



Hoop + Down Arrow: Moves the hoop so the needle will sew lower in the hoop.



Hoop + Left Arrow: Moves the hoop so the needle will farther left in the hoop.



Hoop + Right Arrow: Moves the hoop so the needle will farther right in the hoop.

Trace Design



Hoop + Trace: Traces around the outer edges of the design.

Bypass "Trim Required"



Hoop + Adjustment: Clears and ignores the "Trim Required" message. This indicates to the machine that no thread is through the cloth.

Speed Change



Adjustment + Up Arrow: Increases sew speed by 50 s.p.m.



Adjustment + Down Arrow: Decreases sew speed by 50 s.p.m.

Open/Close Grabber Bar



Adjustment + Center: Opens or closes the grabber bar.

Change Active Needle



Needle Case + Left Arrow: Changes the active needle by moving the needle case to the left.



Needle Case + Right Arrow: Changes the active needle by moving the needle case to the right.

Trim Immediate



Adjustment + Needle Case: Performs a trim command.

Return to Last Stitch



Left Arrow + Right Arrow: If a hoop has been moved during the sewing of a design, pressing this combination will move the hoop back to the position of the most recent stitch to sew.

This can be used to recover the hoop position if the hoop arms get shifted when the e-stop is engaged. Use this command after disengaging the e-stop.

Retain X/Y Position



Up Arrow + Down Arrow: If a hoop has been moved during the sewing of a design, pressing this combination will keep the hoop in the position to continue sewing.

Move to Color



Needle Case + Up Arrow: Moves to the next color in the design.



Needle Case + Down Arrow: Moves to the previous color in the design.

Reset Color Groups



Needle Case + Hoop: Resets the color group letting the machine know that all needles in the group have been threaded.



Note: When the Head Timing Tab is open, the keypad is assigned new functions. Those functions are listed in the Head Timing Section.

LED Indicator

The Status Indicator LED is illuminated when the machine is turned ON.

The LED color and whether it is blinking indicates the machine status or if it has a fault.

Status Light Condition	Definition	Action to Take
Green (blinking)	Machine is on, but no RSA files loaded yet	Start software, check connections
Green (continuous)	Machine is on and ready for operation	
Red (blinking slow)	Indicates a thread break	Re-thread the needle with thread break
Red (blinking fast)	Indicates the machine has run out of bobbin thread	Replace the bobbin
Red (continuous)	Indicates the machine is in E-Stop engaged mode	Release the red emergency stop button

Sewing Your Design

A general checklist for sewing a design would be

- Load a Design
- Set the Color Sequence
- Select a Hoop
- Set the Machine Speed
- Set the Acti-feed
- Check Design Orientation
- Hoop the Garment
- Load the Hoop Onto the Machine
- Adjust the Presser Foot
- Position the Design in the Hoop
- Trace the Design

If you have done all of the above, you are ready to press the start button and watch your design sew.

After the Design is Sewn

After the design is complete, remove the hoop from the machine by gently lifting the spring clips and pulling the hoop free of the hoop arms.

Before giving the garment to the customer, you will want to remove backing, hoop rings, and any top-pings used. This is discussed in the Finishing a Garment section.

Powering Down the Machine

This section will describe how to correctly power down the machine.

Power Down Sequence

1. Close Melco OS.
2. Power down the machine with the power switch.



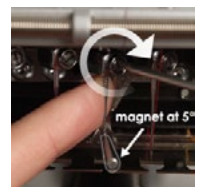
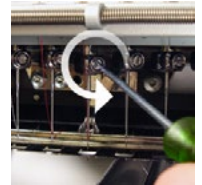
Needle Types and Replacements

Embroidery quality can be greatly effected by your choice of needles. You will need to find what works best with your applications. The following information should help.

Replacing a Needle

Sew conditions and material properties will affect the life of a needle, but eventually, needles will need to be changed.

1. Make sure the safety grabber blade is in the back position before changing a needle. If it is not, press the Adjustment and Center keys on the machine keypad to move the grabber back.
2. Above each needle is a needle clamp set screw that holds it in place. Using a small flat-blade screwdriver, turn the needle clamp set screw counterclockwise about a half of a turn, until the needle can slide down and out of the needle bar. Do not loosen too much or remove the set screw. Loosen the screw just enough for the needle to be removed.
3. Remove the needle by pulling down on the needle.
4. Embroidery needles have a front and a back side. The needle must be installed correctly or the sew quality may suffer. If you install the needle incorrectly, you may also get thread breaks. The front of the needle has a long groove (thread guide), while the back has an indented notch (scarf) just above the eye of the needle.
5. With the thread guide facing forward and the scarf facing back, slide the needle up and into the needle clamp as far as it will go. The eye of the needle should then be turned 5° to the right. The acceptable range is 0° - 20° to the right.
6. A needle orientation magnet may be used to help determine the angle of the needle eye. This cylindrical magnet can be temporarily attached to the front of the needle just above the eye. The end of the magnet will rest on each side of the thread guide and stick straight out from the needle. This will better indicate the angle of the eye. For reference, one minute is 6° on a clock face.
7. While holding the needle in place, re-tighten the needle clamp set screw to hold the needle in place.



Common Reasons to Change the Needle

- The needle breaks or is bent.
- The thread will consistently fray - this usually means there is a bur on the needle causing it to fray a part of the thread.
- The needle is dull.
- Sewing conditions change, such as a change in fabric.

Choosing a Needle

Your machine utilizes DBxK5 needles. Among other things, this means that they are industrial needles with larger eyes.

Needle Sizes

Needles come in a variety of sizes, and most are marked with two numbers. For example, you will find 75/11 needles. The first number is metric and is the diameter of the needle blade. It is measured in hundredths of a millimeter. A 75/11 needle has a blade that is 0.75mm in diameter.

Standard sewing conditions will utilize needle sizes ranging from 65/9 to 80/12 needles.

Smaller needles work well for finer materials, thinner threads, and delicate detail work.

Larger needles work well for tougher and more abrasive materials. As the holes made by the needle are larger, sewing creates less friction on the threads and helps prevent thread breaks.

Size	Benefit	Drawback
60/8	Used for the thinnest threads and finest detail work.	Thinner needle blade is more prone to needle deflection and breakage. Uncommon needle size and can be difficult to source and purchase.
65/9	Smallest of the more common needles. Used for fine fabrics, 60-weight thread, and delicate design details and tiny lettering.	Thinner needle blade is more prone to needle deflection and breakage.
70/10	Used for fine fabrics, design details and small letter. Good needle size for a larger majority of embroidery work.	Thinner needle blade is more prone to needle deflection and breakage.
75/11	Standard needle size and good for the majority of embroidery applications.	May be too large for finer detail work.
80/12	Largest of the more common needles. Often used caps with buckram backing or cotton duct jackets to help alleviate thread breaks.	Larger holes can damage finer materials and smaller design details.
90/14	Used with some specialty and metallic threads.	Larger holes can damage finer materials and smaller design details. Uncommon needle size and can be difficult to source and purchase.
100/16	Used with the thicker 12-weight threads like the wool-acrylic blends.	Larger holes can damage finer materials and smaller design details. Uncommon needle size and can be difficult to source and purchase.

Needle Points

Needle points also come in a variety of options. The main two are sharp and ball point.

Sharp point needles are generally better at cutting through materials and are usually used on tightly woven or non-woven.



Ball point needles are most often used on knit materials. They tend to move the threads of the material to the side of the needle as they sew. Ball point needles are usually marked with a “BP” on the package.

Needle Coatings

Needles are offered with a few different coatings.

Standard needles are silver in color and offer a sewing life of approximately 4 to 6 solid sewing hours.



Titanium needles are gold in color and offer an extended sewing life of 2 to 3 times the life of a standard needle. While they are stronger needles, they have little flex. If deflected, they will often break instead of bend. Titanium needles are usually marked with a “PD” on the packaging.

Other needle coatings exist to cut down on the heat built up when traveling through synthetic materials.

Backings & Toppings

Backings

Appropriate backing is essential for embroidering most fabrics. Without backing, fabrics can slip even when they are hooped tightly. Using the proper backing is directly linked to the production of consistently high quality embroidery. It is important to understand that many different embroiderers with identical criteria may choose completely different backing and topping formulas and still achieve successful embroidery results. Experimentation and experience are essential in creating consistently high quality embroidery. New products are constantly being developed and introduced. Find the combinations that work best for you.

Backing is placed on the underneath side of a fabric before it is embroidered. It is also sometimes referred to as interfacing or stabilizer. Depending on the material, backing can:

- Stabilize the material as it is being sewn
- Provide support for the stitches after sewing is complete

Different backing types provide varying levels of support.

Cut-away

Cut Away backing is a woven or non-woven material that must be cut from the fabric after the embroidery is complete. This type of backing is used to support the embroidery on the fabric during and after the embroidery process. It also prevents the fabric from stretching during embroidery.

Cut-away backing is a great choice for knits or loosely woven materials. These materials tend to move and stretch. The cut-away backing helps to stabilize the material and support the stitches.

Cut-away backing also has a softer feel to it. If the embroidery is going to eventually be against skin directly, consider using cut-away for a more pleasant experience for the wearer.

As the name implies, cut-away backing must be removed by cutting it away with scissors after the embroidery is complete. It is best to remove leaving $\frac{1}{4}$ of an inch edge.

Tear-away

Tear away backing is a non-woven material that tears easily in any direction and can be easily removed after embroidery. Tear away is extremely simple and fast to use, but the uses are limited because it offers little support to unstable fabrics. Some examples of fabrics suitable for tear away are cotton sheeting, heavy woven dress shirts, denim, terry cloth, and hats.

Tear-away backing is a favorite among embroiderers because of its ease of removal. It is simply torn away from the garment after the embroidery is finished.

It often has a feel that is similar to paper, and leftovers can be rough against skin.

It is best used with stable materials, as the backing offers little support for the material.



Specialty Backings

Specialty backings such as poly mesh and nylon mesh are also options. While they may not be as stable as traditional cut-aways, they are much less visible through lighter weight garments. They also tend to be softer than other backings.

Water soluble backing is also available for jobs that require that no backing be left after the completion of the embroidery. Be aware that this would require a fairly stable garment as the backing will be dissolved completely and offer no support once the garment has been laundered.

Backing Choice Example

The choice of backing impacts the quality of the embroidery greatly. The following examples were sewn on the same machine with all the same settings. The only difference was the choice of backing.

Embroidery on T-Shirt	
	
Cut-away backing provides needed stability to the thin knit of a T-shirt. The embroidery holds the shape of the design.	Tear-away backing does not hold up to the embroidery. The stitching is allowed to pull in and the borders do not line up.

Embroidery on T-Shirt



Cut-away backing provides needed stability to the thin knit of a T-shirt. The embroidery holds the shape of the design.



Tear-away backing allows the T-shirt to pull and pucker as the design is sewn.

Backing Weights

Backing comes in different thicknesses. Many times, you can ask for sample packets from suppliers to find what will work best with your application.


Heavier backings tend to offer more support. Lighter backings are often less visible. Because finding the right backing for the application requires some experience or experimentation, having a medium weight backing is a good starting place for new embroiderers.

Toppings

Toppings are used to keep your stitches from falling into the nap of a lofty material like terry cloth or polar fleece. It can also be used to clean up small lettering and the overall appearance of your embroidery. Most toppings are water-soluble and can be easily removed after the embroidery is complete.

Thread Types

Thread comes in many styles, weights, and compositions. Understanding the differences can help determine the appropriate thread for the job.

 *Manufacturers and suppliers often have fact sheets with sewing tips, design settings, and needle recommendations on their websites. This is very useful in learning to use a variety of thread types.*


Thread Types

Thread comes in a few compositions. These have different properties that can drastically affect sewing and quality.

Polyester

Polyester thread has become the standard thread for Melco embroidery machine users.

- Stronger than other threads
- Fewer thread breaks when sewing
- Colorfast and resistant to chlorine making it ideal for garments that are washed frequently. It is perfect for uniforms and corporate apparel.
- Comes in a wide variety of colors

 *Polyester thread is recommended for use with your machine to achieve full sew speed and prevent thread breaks.*

Metallic

Metallic threads are often used to add a bit of sparkle to a design.

- High sheen or sometimes a matte finish
- Can be more problematic to sew with
- Requires lighter densities and longer stitch lengths
- Usually requires slower sew speeds and larger needles

Wool/Acrylic Blend

Usually a heavier thread, these threads can be used for a more natural or hand look.

- Unique look
- Can be more problematic to sew with
- Requires much lighter densities and longer stitch lengths
- Usually requires slower sew speeds and larger needles

Rayon

Rayon threads are made of natural fibers and can have slightly higher sheens than polyester.

- Wide variety of colors
- Beautiful Sheen
- Less strength than polyester
- Not chlorine resistant
- Usually requires slower sew speeds

Thread Weight (Thickness)

Thread is commonly referred to by its weight. In many cases, this is a number beside the type. For example, you might find a "Poly 40". This number usually means that it would require 40 kilometers of thread to weigh 1 kilogram. With this method, the higher the number, the thinner the thread.

- 40 weight thread is the industry standard for embroidery. Most stock designs are digitized for use with 40 weight.
- 60 weight thread is excellent for fine details and small lettering.
- 12 weight thread is very thick and can work well for a hand embroidery look.

Each thread weight will require different needles and design specifications.

Sewing Caps

Sewing caps will require a little more setup than sewing a flat product. For sewing caps, you will need to do the following.

- Select the appropriate hoop in software
- Load the Wide Angle Driver (this may need adjustment the first time)
- Hoop a cap - this will change depending on the cap frame. Conventional Cap Frame (CCF) or Wide Angle Cap Frame (WACF)
- Load the hooped cap onto the driver
- Set up the design for caps
- Load the design and proper settings
- Adjust the presser foot for the cap
- Center the design on the cap

The next few sections of this document will assist in sewing a cap.

Select the Hoop

From the hoop selection drop-down, select the hoop you are planning on using. Selecting the hoop before loading the driver onto the machine isn't necessary, but it can make the process easier.

Installing & Removing the Wide Angle Driver

Both the cap frames and the micro clamps utilize the Wide Angle Driver. The Red Wide Angle Driver consists of two pieces:

- The (red) cap frame driver ring
- The lower arm bracket



You must ALWAYS select the proper cap frame hoop in the software when sewing with cap frames. Failure to do so may result in damage to your equipment!

Red Wide Angle Driver Installation

1. Start with the correct hoop selected and displayed on screen.
2. Center the hoop on the machine by either pressing the "Hoop" and "Center" keys simultaneously on the machine keypad or pressing the "Move To Center" button under the Move Screen in the software. If the hoop is already at center, this button will be slightly transparent and unavailable.

 +  on the machine keypad

or



in the software

3. It is also beneficial to move the machine to either needle 8 or needle 9. This can be done by pressing the "Needlecase" key and the "Left" or "Right" arrow key on the machine keypad.

 +  or  + 

4. If attached, remove the hoop arms from the machine. To do this, use a 6mm Allen wrench to loosen the two thumb screws attaching each arm. Unscrew them and remove the arms.



Failure to remove the hoop arms will result in the wide angle driver colliding with the arms during sewing.

5. Remove the hook guard by loosening the screws on either side of the lower arm with a 2mm hex wrench, and sliding the hook guard forward. The screws do not need to be completely removed.



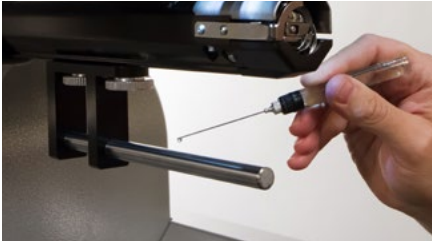
6. Loosen the knobs of the lower shaft support until the top of screws are flush with the t-nut.
7. Slide the shaft support mount into the lower arm extrusion and toward the back of the machine until it contacts the hard stop. It should slide smoothly into the t-channel. The t-nut must go all the way back to the hard stop or the shaft will be set too far forward on the machine.



8. Tighten the two knobs.



9. Reattach the hook guard by sliding it back into place and tightening the two small screws with a 2mm hex wrench.
10. A few drops of sewing machine oil should be applied to the lower support shaft prior to the initial installation of the driver ring assembly. Later installations should not require this step.



11. Slide the red driver assembly onto the lower arm and support shaft. This may be easier if the grabber bar of the machine is closed. To close the bar, simultaneously press the "Adjustment" and "Center" keys on the keypad of the machine.



Then, slide the red driver assembly onto the lower arm and support shaft. Notice the orientation

of the ring in the picture.



- Using two of the thumb screws from the hoop arms, attach the red driver to the x-carriage of the machine. The driver will attach to the two innermost holes. Tighten them to finger-tight, and then use a 6mm Allen wrench to tighten an eighth to quarter turn more. Do not over-tighten the screws as they are designed to break before damage to the machine can occur.



The red driver ring should slide easily over the lower arm of the machine and should allow for a business card or two to fit between the ring and the lower arm. The space should be enough for the card(s), but no more. If the gap between the ring and the lower arm is incorrect, or if you are unable to install the driver, it will need to be adjusted. See the adjustment section for instructions on how to test and adjust.

- The Red Wide Angle Driver is now installed and ready to use.

Remove the support wings if using the Conventional Cap Frame or micro clamps. Support wings may also need to be removed when design size pushes the physical limits of a specific cap. For instructions on removing the support wings, see the corresponding section of this document.

Red Wide Angle Driver Removal

1. Starting with a 6mm Allen wrench, remove the thumbscrews attaching the red driver assembly to the x-carriage.



2. Slide the red driver assembly toward you and off of the lower arm and support shaft. This may be easier if the grabber bar of the machine is closed. To close the bar, simultaneously press the "Adjustment" and "Center" keys on the keypad of the machine.



3. Remove the hook guard by loosening the screws on both sides of the lower arm using a 2mm hex wrench, and sliding the hook guard forward. The screws do not need to be completely removed.



4. Loosen the knobs of the lower shaft support. Then, slide the lower support shaft out of the t-channel and off the machine.



5. Reattach the hook guard by sliding it back into place and tightening the two screws using a 2mm hex wrench.
6. The wide angle driver is now removed. Hoop arms can be reattached to sew with standard hoops.

Red Wide Angle Driver Cap Support Wings (Option)

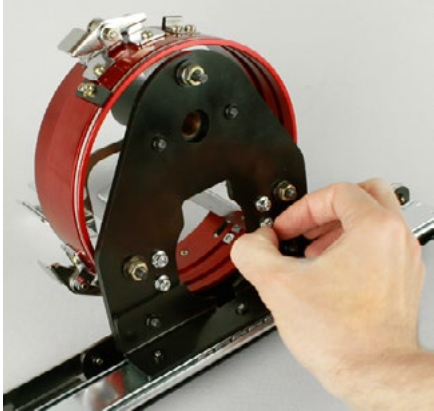
The cap support wings of the wide angle driver will need to be removed to use the driver with the Conventional Cap Frame (CCF) or any of the Micro Clamps. They may also need to be removed for any design that pushes the physical limit of any specific cap style or a smaller cap.

Installation and Adjustment of the Cap Support Wing Assembly (Option)

1. Remove the driver cylinder from the machine and lay it upside down on a flat surface.
2. Remove the 4 nuts from the threaded standoffs of the cap support wing assembly.
3. Make sure the 2 phillips head screws on the connecting bracket are loose.
4. Install the cap support assembly on the driver cylinder. Slightly pivot the assembly left and then right during the installation to ease each post past the white rollers.



5. Assemble the 4 nuts onto the threaded posts by hand. Allow them to stay slightly loose. This will enable the adjustment of the support wing assembly to the machine.

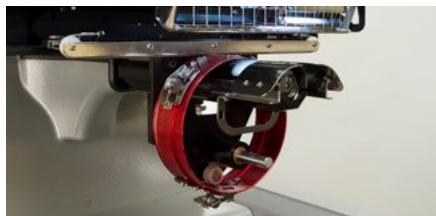


6. With the cap support wing assembly loosely installed on the wide angle driver, install the driver onto the machine.

- Using two of the thumb screws from the hoop arms, attach the red driver to the x-carriage of the machine. Tighten them to finger-tight, and then use a 6mm allen wrench to tight an eighth to quarter turn more.



Do not over-tighten the screws as they are designed to break before damage to the machine can occur.



- Move the driver and carriage back until the cap support wing assembly fully covers the needle plate.



- Place a business card between the cap support wings and the needle plate.



- Adjust one side of the cap support until it makes contact with the business card and needle plate. Tighten the two nuts on the back of the driver.



11. Repeat this process for the other side of the cap support.



When installing the cap support wings, ensure that there is a small gap between the cap support wing mounting bracket and the white roller. If no gap is present, it will cause wear on the parts.



12. Tighten the two phillips head screws on the connecting bracket.
13. Remove the business card and check that there is a gap between the cap support wings and the needle plate. Repeat the steps above if required to achieve a slight gap.



Removal of the Cap Support Wing Assembly (Option)

1. Remove the driver cylinder from the machine and lay it upside down on a flat surface.
2. Loosen, but do not remove, the two phillips screws from the cap support connecting bracket.



3. Remove the four nuts on the back of the driver. A 7mm hex driver or wrench will be needed.



4. Remove the cap support wing assembly. Slightly pivot the assembly from left to right and back again while removing it. This will help to ease each leg around the roller.



5. Place the 4 nuts back on the threaded standoffs of the cap support wing assembly to prevent their loss.



Adjusting the Red Wide Angle Driver

This procedure may need to be performed if the Red Wide Angle Driver was purchased separately from your machine, the driver has been dropped or mishandled, if the initial installation of the driver shows the adjustment to be off, or if prompted by technical support.

The Red Wide Angle Driver may need to be adjusted to custom-fit each machine. A driver that is not properly adjusted to the machine it is used on will result in negative impact to sew out quality and machine productivity and reliability.

The following tools will be used:

- Screwdriver, Hex Drive, Ball End, 4mm
- Hex Set, 7 Pieces, Metric Long – 6mm and 2mm

Testing for Appropriate Adjustment

1. Install the driver using the instructions for Installing the Red Wide Angle Driver.
2. Position the driver so that the bushing is aligned to the front of the support shaft and the driver ring is centered with the hole in the needle plate. Reference the ring's frame location tab.



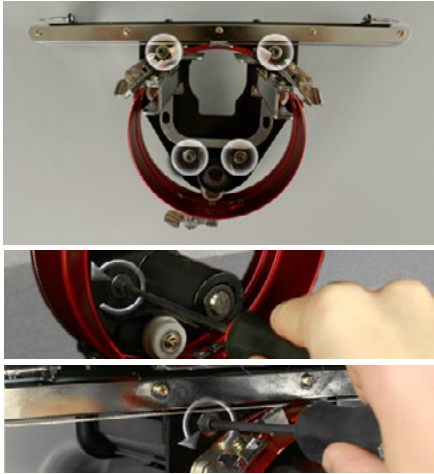
3. Place a business card of medium to heavy stock (or equivalent) between the needle plate and the driver ring. A single business card should be able to slide between them with little resistance. A gap of two business cards is acceptable.



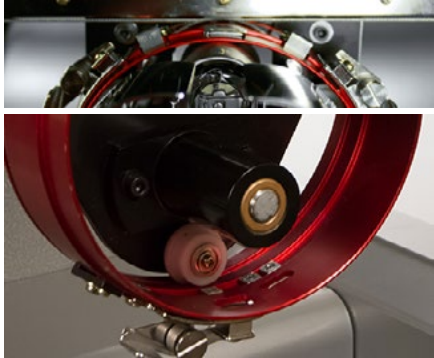
4. If the gap is too small or too large, the driver will need to be adjusted using the steps below.

Adjustment Procedure

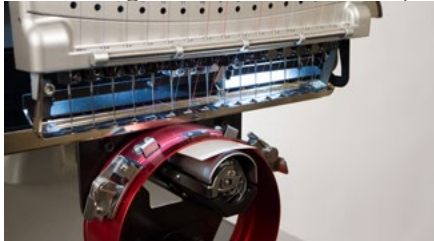
1. Begin by loosening the two bearing block hex screws and the two interface bracket screws using the 4mm hex screwdriver.



2. Install the Red Wide Angle Driver on your machine. See the installation section of the document for details.
3. Position the driver so that the bushing is aligned to the front of the support shaft and the driver ring is centered with the hole in the needle plate. Reference the ring's frame location tab.



4. Place a business card of medium to heavy stock (or equivalent) between the needle plate and the driver ring. This will act as a spacer. The ring should just rest on the card.



5. Making sure the edges of the two black brackets are aligned, tighten one of the upper screws.



6. Tighten the opposite screw securing the bearing mounting block.



7. Tighten the second upper screw securing the bracket and then the second lower screw securing the bearing mounting bracket. Tightening these four screws in a star-like pattern achieves the best results. Then remove the business card.



8. Move the y-beam and x-carriage by hand to ensure there is no binding. This can only be accomplished with the machine off or the e-stop engaged.



If using the red wide angle driver with the Conventional Cap Frame or any of the micro-clamps, the cap support wings must be removed to prevent interference with the frames.

Selecting Hoops for the Wide Angle Driver

When selecting a hoop for use with the wide angle driver, select a hoop that is labeled with the driver color first.

Hoop	Red Driver	Graphite Driver
	Red WACF	Graphite WACF
	Red CCF	Graphite CCF
	Red Micro (2.6 x 3.7in)	Graphite Micro (2.6 x 3.7in)
	Red Micro (3.1 x 3.7in)	Graphite Micro (3.1 x 3.7in)
	Red Micro (3.6 x 3.7in)	Graphite Micro (3.6 x 3.7in)

Hooping a Cap on the Conventional Cap Frame

The process for hooping a cap on the CCF is the same for almost any type of cap you are hooping.

Prepare the Cap

Preparing the cap before it is hooped will help the sew quality and ease the hooping process.

To prepare the cap,

1. Remove any cardboard from the inside of the cap.



2. Straighten the bill as best you can. It can be reshaped after the embroidery is complete.



3. Pull the sweatband to the outside of the cap. Near the back of the cap, the sweatband may be sewn into the cap. At this point, it may need to be folded a bit to fit in the frame.



4. If the cap has a braid, move it around the cap to the inside and under the brim.

Hooping the Cap

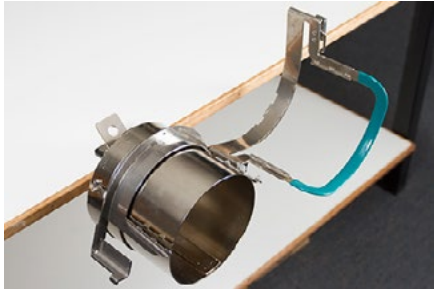
To hoop the cap,

1. Slide the cap frame onto the cap gauge. Make sure the locating tab on the cap gauge fits into the cap frame notch and the cap frame slips firmly under the two roller clips. Watch your fingers!

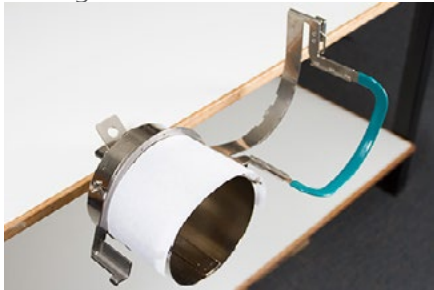
Don't pinch them between the back of the frame and the gauge.



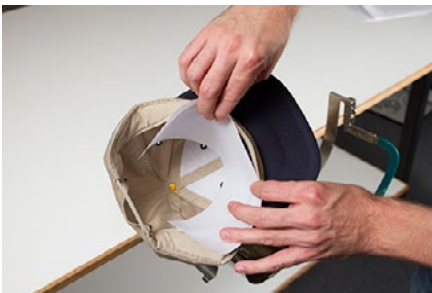
2. Unlatch the cap frame and swing the frame open and to the right. Do this by pulling the tab away from the frame. Then, press down on the edge of the frame to free the latch from the hook. Swing the frame open.



3. Place an appropriate backing over the gauge and the teeth of the cap frame. Make sure that the backing is long enough to support the full embroidery area. It may be easiest to use backing long enough to reach the teeth on each side of the cap frame.



You may find it easier to place the backing inside the cap and load both the backing and the cap onto the frame at the same time. Use what method works best for you.



4. Slide the prepared cap onto the cap frame with the visor pointing up and the frame going inside the cap. Make sure that the sweatband is flipped to the outside of the cap.



The sweatband may not touch the vertical ridge of the frame. That's okay. Different caps have varying sweatband widths and not all will appear the same when hooped.

5. The cap and backing should ride over the two posts with teeth on the sides of the frame.
6. Begin to close the frame. Insert the cap bill into the slot in the cap frame as you swing the frame closed over the front of the cap.
7. With the frame closed but not latched, adjust the position of the cap. Center the seam and level the cap as best you can.



8. Gently pull from the back of the cap. This will pull the cap down and snug against the frame.
9. With slight pressure still being applied to the back of the cap,
 - Push down on the end (top) of the bill to seat it against the top of the cap frame support.
 - Push back on the base of the bill to hold it against the plate at the front of the cap frame.
 - Push down on the middle top of the cap frame strap to seat it around the sweat band.



10. While holding the cap frame strap down around the sweat band, release the back of the cap and attach the strap latch over the hook on the support. Pull the tab to latch the cap frame.
11. You may now remove the cap frame from the gauge by pulling back on the handle.
12. The cap is now ready to be placed on the wide angle driver on the machine.

Hooping a Cap on the Wide Angle Cap Frame

The process for hooping a cap on the WACF is the same for almost any type of cap or visor you are hooping.

Prepare the Cap

Preparing the cap before it is hooped will help the sew quality and ease the hooping process.

To prepare the cap,

1. Remove any cardboard from the inside of the cap.



2. Straighten the bill as best you can. It can be reshaped after the embroidery is complete.



3. Pull the sweatband to the outside of the cap. Near the back of the cap, the sweatband may be sewn into the cap. At this point, it may need to be folded a bit to fit in the frame.



4. If the cap has a braid, move it around the cap to the inside and under the brim.

Hooping the Cap

To hoop the cap,

1. Slide the cap frame onto the cap gauge. Make sure the locating tab on the cap gauge fits into the cap frame notch and the cap frame slips firmly under the two roller clips. Watch your fingers!

Don't pinch them between the back of the frame and the gauge.



2. Swing the metal strap open.



3. Place an appropriate backing over the gauge and the teeth of the cap frame. Make sure that the backing is long enough to support the full embroidery area. It may be easiest to use backing long enough to reach the posts on the bottom of the cap frame.



Some people find it easier to use the binder clips to hold the backing while they are hooping the cap. The downside to this technique is that you have to remove the clips from inside the cap when you are done hooping. That isn't always easy.

Clipping the backing before hooping the cap is completely optional.



4. Slide the prepared cap onto the cap frame with the visor pointing up and the frame going inside the cap. The bill should be pushed against the bill-stop on the frame. The bill should also be

relatively centered on the frame. The centering mark on the bill-stop can be used for reference.



The sweatband may not touch the vertical ridge of the frame. That's okay. Different caps have varying sweatband widths and not all will appear the same when hooped.

5. The cap should ride over the two clip posts toward the bottom of each side of the frame.
6. Press down on the bill to ensure that it is falling in the bill trough of the cap frame. This will help keep the cap from slipping around or off the frame when the cap is being sewn.

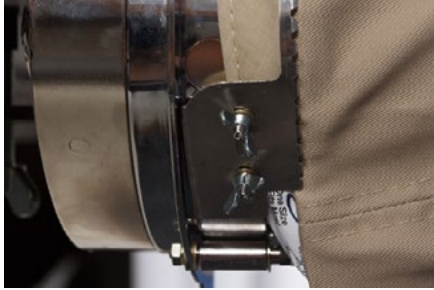


7. Pull the side of the sweatband toward the cap frame and down. Smooth any bunching of the cap sides or sweatband. You may eventually need to fold the sweatband a bit to avoid the latching hook. But this will help with the placement of the cap on the frame. As you do this, watch the backing to ensure it is still in place.



8. When the left side of the cap is within the strap hinge post, swing the strap up and over the cap brim. On the side of the cap, the teeth of the strap should fall just above the seam attaching the

sweatband of to the cap.



9. Continue bringing the strap around the front of the cap. On the front of the cap, the teeth of the strap must fall into the seam for the bill.



10. Bring the strap down the other side of the cap. Make sure the teeth of the strap fall just above the stitching attaching the sweat band. This will help ensure a level sewout.

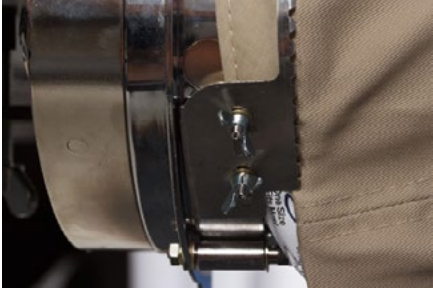


11. Hook the latch on the strap into the hook on the latch post. You may need to fold or adjust the sweatband of the cap slightly to accommodate the hook and latch. At this point, you want to hook the latch, but not close the latch.



12. The cap frame strap may need to be tightened if it does not fit the cap snugly or loosened should it be too tight to fasten appropriately. This is only necessary when hooping a different style of cap for the first time using the cap frame. Subsequent hoopings of that style should fit well after the adjustment.

- To adjust the cap frame strap, loosen the two wing nuts on the left side of the frame.



- Then, push the strap down against the cap brim moving from the latch toward the wing nuts so that it is very snug to the cap.



- Slide the strap toward the wing nut to remove the excess.



- Tighten the wing nuts while holding the strap tight against the cap.

13. Smooth the lower part of the cap while snapping the buckle closed. The buckle should be tight.



14. If clips were used to secure the backing while hooping, remove them now.



15. If sewing on the sides of the cap, smooth the cap material backward and over the clip posts on the both sides. Indent the cap material along the clip posts.
16. While pressing the cap material around the post, use a clip to secure the material to the post. Orient the clip handles toward the back of the cap.



These are only necessary when sewing the sides of the cap or if the cap is unstructured.

17. You may now remove the cap frame from the gauge.
- To do this, place the palms of your hands on the gauge and place your fingers on the frame.



- Pull your fingers toward your palms until the cap frame release from the gauge.

- Inspect the hooping. Look at the inside of the cap to ensure that the backing is not bunched and that it is caught in the teeth of the frame.



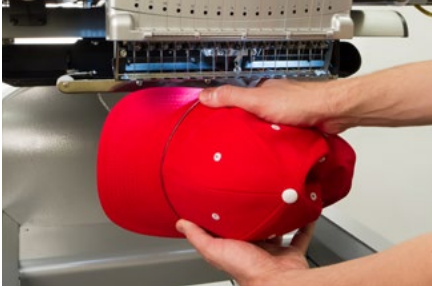
18. The cap is now ready to be placed on the wide angle driver on the machine.

Loading/Removing a Hoop with the Wide Angle Driver

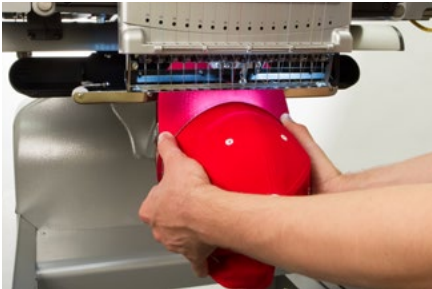
Loading a Hoop

To load a hooped cap onto the installed wide angle driver, use the following steps.

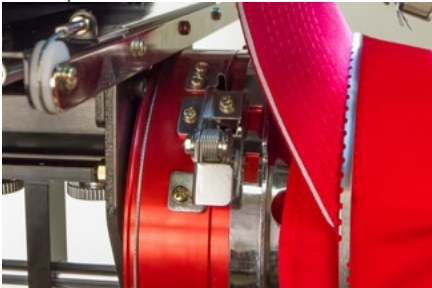
1. Rotate the hooped cap so the bill 90° to allow the bill to pass under the needle case.



2. Rotate the bill back up so that it is behind the needle case and the location tab on the driver aligns with the notch in the frame.



3. This also aligns the rectangular holes along the edge of the frame with the spring loaded locking clamps on the driver.



4. With the frame aligned, press the frame toward the driver until the three (3) spring loaded locking clamps snap into place. It may be helpful to grasp the back of the driver and close your grip to

push the cap into place as pictured.



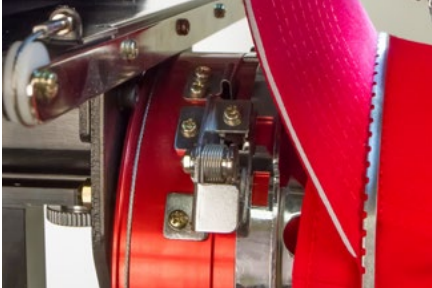
Removing a Hoop

To remove a hooped cap from the installed Red Wide Angle Driver, use the following steps.

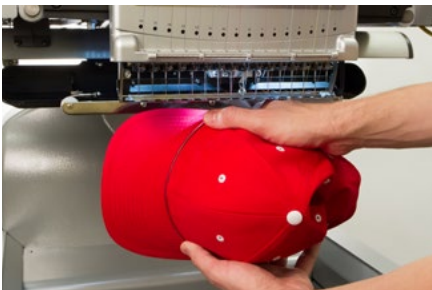
1. Press the three locking clamps on the driver while gently pulling back on the frame.



2. This will allow the frame to release and be pulled free from the driver.



3. Rotate the hooped cap 90° so the bill can pass under the needle case. The hoop can now be removed from the machine.



Digitizing for Caps

Setting up designs for caps requires a few considerations. Make sure that the design is of an appropriate size for the profile of the cap and ensure that the sew path will not create ripples, thread breaks, needle breaks, or registration issues. Consider the following when designing for caps.

- Design Size for Caps
- Sew Order for Cap Designs
 - Sew From the Bill Toward the Crown
 - Sew From the Center Toward the Sides
 - “Finish Elements As You Go”

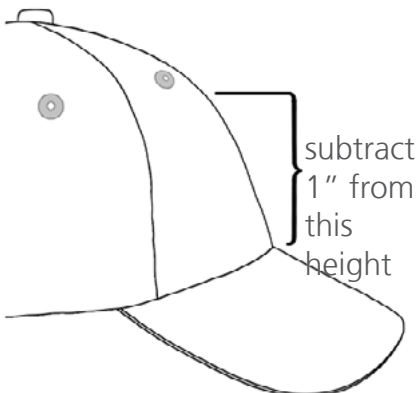
Design Size for Caps

The cap frame that you are using will most likely handle a much larger design than the cap itself. The size of a design that is able to be sewn on a cap depends on the profile of the cap itself. Higher profile caps can accommodate much larger designs than lower profile caps.

As designs sew toward the top of the cap, the inside of the cap can brush the lower arm of the machine and restrict cap movement. This can cause some distortion and cause vertical lines to appear as if the tops move in toward the center of the cap. If the design sews even farther up on the cap, the pressure of the lower arm against the inside of the cap can cause the cap to be pushed off the frame.

To figure out how large of a design can safely fit on the cap,

1. Measure from the bill to where the cap really starts to curve over the head of the potential wearer. This will require a little bit of judgment.
2. Subtract one inch from that measurement to find a fairly safe design height. Stay within this size if the design contains right angles, borders, or fine details.
3. If the design is more organic and contains few borders or details, the size can slightly ($\approx 1/2$ "") exceed the safe area calculated in the step above. However, some trapezoidal distortion may be noticeable.
4. The width of the design depends on the cap frame.



Sew Order for Cap Designs

Now that you have the size of the design figured out, the design needs to be digitized for a cap.

One of the challenges with embroidering caps is that the fabric moves and flags. The trick to sewing caps successfully is to use the design sew order to move the material where it can do little harm.

For cap designs, follow these three guidelines.

- Sew from the bottom (bill) toward the top (crown).
- Sew from the center (seam) toward the sides.
- Finish elements as you go. While less efficient, completing designs in smaller portions will help keep a tighter registration and help outlines and borders line up.

In embroidery, it is often a good idea to avoid sewing toward an anchor point. If the material is anchored to the backing or another element of the garment, like the bill of a cap, it will not move. Sewing toward one of these anchors can push a ripple of material. Once the anchor point is reached, the excess material has no place to go and a ripple is sewn into the garment.

Sew From the Bill Toward the Crown

The bill of the cap poses a bit more of a challenge if the material is stiff. A ripple of material formed from sewing toward the bill of a cap can deflect a needle and cause thread breaks and needle breaks.

Sew From the Center Toward the Sides

Digitizing the sew path to sew away from the bill and away from the center seam will help maintain design registration and avoid thread and needle breaks.



“Finish Elements As You Go”

Finishing elements as you go will mostly help with registration. For example, if you were setting up a design of lettering with borders, try sewing a letter or two and then bordering them. Sewing the whole word and then all the borders may sound more efficient, but it can result in material push and registration loss.

Sew Settings for Caps

The settings in the software will need to be adjusted for better quality on a cap. Be sure to address the following.

Design Orientation

To be oriented appropriately for a cap, the design usually needs to be rotated 180° in the software. For assistance on this, review the Design Orientation & Rotation section of this document.

Sew Speed

Sew speed for caps will need to be adjusted. Because the material is going around instead of back and forth, the machine speed will need to be set between 850 - 1200 stitches per minute. For newer embroiderers, starting at 1000 s.p.m. and adjusting from there may be a good idea.

For more information on setting the sew speed, see the machine speed section.

Material Thickness

Don't forget to change the material thickness for caps. There is a suggested cap setting that can be fine tuned as you are sewing. For more information, see the material thickness section of this document.

Adjusting the Presser Foot for Caps

The presser foot will need to be adjusted any time you significantly change the thickness of the material you're sewing on.

With caps, adjusting the presser foot is a little different than with flat goods. Because they cap flags (bounces) and has a seam, it is often best to set the presser foot to a standard setting and adjust from there.

Make sure the machine is stopped.

Adjust the presser foot by rotating the adjustment gear counter clockwise until it can no longer rotate. This will take the presser foot to the lowest position possible. This can be accomplished with the needle at head up (default position) or at bottom center (as described in the adjusting the presser foot section).

If the needle is not at the presser foot adjustment point, the presser foot will not appear to move. Even if the needle is at the adjustment point, it may be difficult to see a change in the presser foot. The material of the cap is pressing up against it and you may not see it lift off the material. This is normal and will not affect the actual adjustment.

With the presser foot adjusted all the way down, rotate the gear clockwise and bring the presser foot back up. Count the clicks of the gear. Raise the presser foot two clicks back up. Again, you most likely will not see the presser foot move.

With the presser foot two clicks up from the bottom, your machine is adjusted and you are ready to trace the design and sew it out.

Centering a Design on a Cap

Unless you hooped absolutely perfectly, and that is exceeding difficult to do, you will most likely need to adjust the hoop position on the machine to better center the design on your cap.

The best way to accomplish this is to have the hoop loaded on the machine first.

Screen Versus Cap

Pressing the move to Center button in the software or commanding it from the keypad of the machine is convenient, but it doesn't work well for caps. It functions by centering the hoop or frame to the machine.

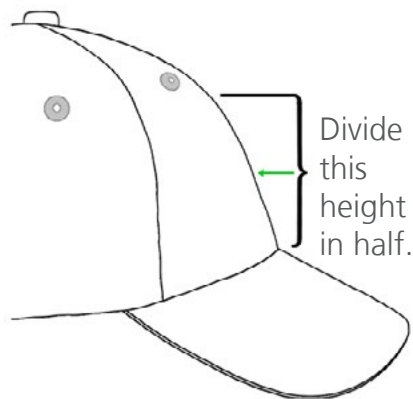
The software will display the frame limits. Centering the design within these limits will not necessarily center the design on the cap. Because caps have different profiles and embroiderers hoop inconsistently, small adjustments may need to be made to the hoop placement.

When the design is centered on the cap, the placement may appear to be off in the software and on screen.

Centering Vertically

Centering the design vertically will take a bit of measuring, but it only needs to be done once for a particular style of cap. Additional caps will not require vertical adjustments.

To find an appropriate vertical placement on the cap, measure from the bill of the cap to where the curve really starts to come over the head. This is similar to measuring the design height that the cap can accommodate. Once measured, divide the measurement in half. Measure up from the bill that half distance to find a good vertically centered placement for the design.



Marking this measurement on the cap with masking tape or tailor's chalk works well. Use the hoop and up or down arrows to move the hoop into position. As you use these keys, the machine's laser will illuminate the placement.

Centering Horizontally

With the cap frame loaded on the machine, use the Hoop Key and the left or right arrow on the machine keypad to center the cap horizontally. If the cap has six panels, you will have a seam running down the middle of the front. This acts as a marker for center. If the cap has five panels, it will not have a seam, and you may need to use a tape measure and tailor's chalk to find center.

Using the laser to line up to center may not work as well in this case. As the cap comes off the needle plate, the laser is displayed farther to the right. This is from the laser being set just behind the right upper arm front cover of the machine.

For a more accurate placement, line up the active needle (the needle with the presser foot behind it).

Trace the Design

Tracing the design using the hoop and trace keys simultaneously on the keypad of the machine will also give you a good idea of where the design will be sewn.

Watch the Hoop Limits

Depending on the structure of the cap, you will be able to sew within varying distances from the hoop limits. Softer, thinner, and more pliable materials will allow you to sew closer to the limit. Tougher and less flexible materials may cause the fabric to ramp up at the teeth causing flagging, needle deflection, and thread or needle breaks.

Wide Angle Driver Maintenance

Maintenance will need to be performed on your machine to keep it running at an optimal level. Machine maintenance procedures can be found under the Settings Screen.

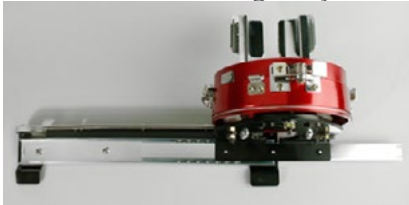
The Maintenance Screen will display procedures for the hook, weekly, monthly, and quarterly maintenance. Each procedure will move the machine to the appropriate location and walk through all the proper lubrications.

Hook maintenance should be performed every day before sewing and again after every four hours of solid sewing.

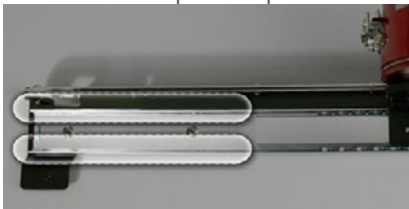
Wide Angle Driver Maintenance

Approximately once per year, the red wide angle driver will need to be cleaned and greased. The following steps will walk you through the procedure.

1. Remove the driver cylinder from the machine and lay it upside down on a flat surface.
2. Slide the driver ring fully to one side.



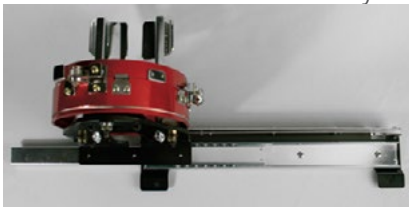
3. Clean the exposed portion of the exposed slider bearing groove with a clean towel.



4. Apply a thin film of hp grease to the grooves of the slider bearing.



5. Move the driver all the way to the opposite side and repeat the previous two steps.



6. Move the driver back and forth a few times to spread the grease.
7. The driver may now be reinstalled on the machine or stored for future use.

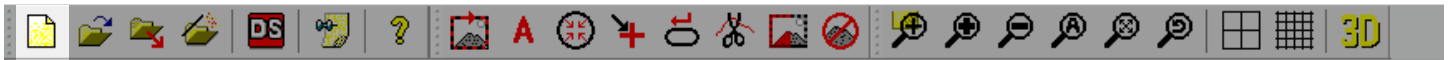
Melco OS Menu Items

This section will describe the options and commands listed under the menu items in Melco OS.

File Menu

New

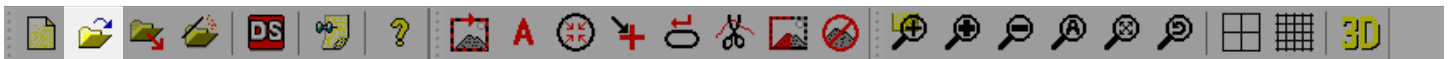
Selecting File>New creates a new project file in whatever level of DesignShop you have loaded. You can find this function in two locations. It is found on the toolbar button or under the File Menu.



 Note that this function is a link to DesignShop and not internal to Melco OS.

Open

Selecting File>Open will provide you with the Open dialog box to open a design in whatever level of DesignShop is loaded. In this dialog box, you have the ability to browse for the desired file or project. You also have the ability to view a thumbnail image of each design as it is selected. The thumbnail image is displayed on the right side of the Open dialogue box. You can find this function in two locations. It is found on the toolbar button or under the File Menu. The keyboard shortcut key for this is CTRL+O.



 Note that this function is a link to DesignShop and not internal to Melco OS.

At the bottom of the open dialog box is a drop-down menu listing the file types that can be opened.

Load Design

Selecting File>Load Design opens a dialog box for selecting a design to load to your machine. You can find this function in two locations. It is found on the toolbar button or under the File Menu.



Loading a design is covered in the Loading a Design section.

Load Design Wizard

Selecting File>Load Design Wizard opens a dialog box for selecting a design to load to your machine. After the design is loaded, the wizard will move to setting the color sequence, selecting the hoop, setting the sew speed, and selecting the acti-feed settings. You can find this function in two locations. It is found on the toolbar button or under the File Menu.



Loading a design using the wizard is covered in the Loading a Design section.

Load Job From Machine

Selecting File>Load Job From Machine allows you to load a design from one machine memory to another in a multiple machine setup. Using this feature will bring up a dialogue box that will list all available machines and provide the option for loading any design that remain in any of those machine memories.

Queue Design

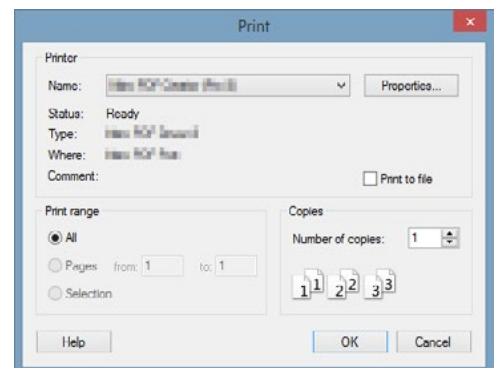
Selecting File>Queue Design allows you to add jobs to the jobs list in the Design Queue tab. This function brings up a dialog box like the load or open design functions. This is discussed further in the Design Queue Section.

Save As

Selecting File>Save As allows you to save the currently loaded design as an OFM file. Saving a design out of Melco OS saves not only the design information, but it also saves the machine settings. The Universal OFM file is the only file type that can contain these machine settings.

Print

Selecting File>Print allows you to print a preview of the loaded design to paper. This function brings up a standard dialog box in which the printer may be selected as well as the desired number of copies. Click or tap the OK button to print.



Print Preview

Selecting File>Print Preview allows you to preview the printed page on screen before sending the design preview to the printer.

Print Setup

Selecting File>Print Setup allows you to set the desired printer and number of copies. It brings up the same dialog box as "Print" does, but clicking the OK button doesn't print a design preview. It merely saves the printer settings.

View Design Notes

Selecting File>View Design Notes allows you to review and edit a text document that is saved with an OFM file. These notes can be used to store information about the job, the customer, run or application settings, as well as what types of thread, backing, and needles were used to make the job successful.

You can find this function in two locations. It is found on the toolbar button or under the File Menu.




Exit

Selecting File>Exit will close the Melco OS software.

View Menu

The first set of functions under the View menu are a few of the zoom tools. These tools allow for more flexibility in how you view the design.

 *Note that the zoom tools do not change the size of the design. The only change how closely you are view it.*

Zoom In

Selecting View>Zoom In will zoom into the center of the view window in Melco OS. The Zoom In function allows you to zoom into the design every time you use the command. You can find this function in two locations. It is found on the toolbar button or under the View Menu.



Zoom Out

Selecting View>Zoom Out will zoom out from the center of the view window in Melco OS. The Zoom In function allows you to zoom into the design every time you use the command. You can find this function in two locations. It is found on the toolbar button or under the View Menu.



Actual Size

Selecting View>Actual Size will zoom in or out to display the design on screen as close to the actual physical size of the design as possible. This may change slightly depending on your screen resolution settings. If the physical size of the design is larger than the view window in the software, not all of the design will be displayed. You can find this function in two locations. It is found on the toolbar button or under the View Menu.



Fit Window

Selecting View>Fit Window will zoom in or out to display the design on screen as largely as possible while still displaying the entire design within the view window. You can find this function in two locations. It is found on the toolbar button or under the View Menu.



Previous View

Selecting View>Previous View will return to the previous zoom level. You can find this function in two locations. It is found on the toolbar button or under the View Menu.



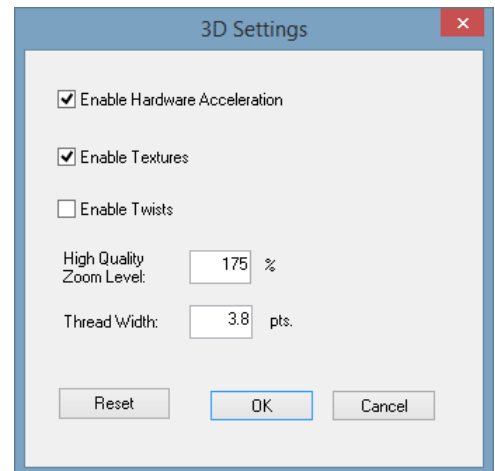
Show in 3D

Selecting View>Show in 3D will display the design rendered with the illusion of depth. Each thread is given thickness and a bit of texture as well as the illusion of light across the surface. You can find this function in two locations. It is found on the toolbar button or under the View Menu.



Settings for this feature can be altered by right-clicking on the icon in the toolbar.

- Enable Hardware Acceleration: This setting allows 3D acceleration with the video card in the computer.
- Enable Textures: This feature gives the stitches a mottled effect simulating the play of light on a textured thread.
- Enable Twists: At higher zoom levels as specified by the "High Quality Zoom Level" field, the threads will appear with twists. This is meant to simulate the twists in the actual thread.
- High Quality Zoom Level: This setting determines when the twists of thread are shown if that feature is enabled.
- Thread Width: This setting changes the thickness of thread when displayed in 3D.
- Reset Button: Use this button to reset the 3D Settings back to the software defaults.



Note: This feature is for rendering stitches on screen in a more realistic way. It is not meant to set up a design for use with 3D foam embroidery.

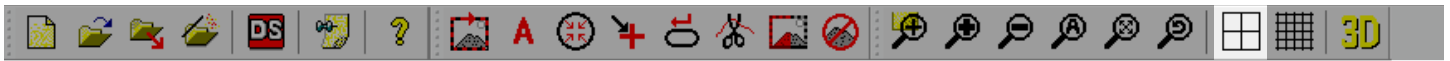
Stitches Sewn Only

Selecting View>Stitches Sewn Only will display the design on screen as the design is being sewn. The entire design will begin displayed in grey. The stitches will color in as they are sewn. You can find this function in two locations. It is found on the toolbar button or under the View Menu.



Design Origin

Selecting View>Design Origin will display the origin. By default, it will show the center of the machine. It shows the x-home axis and the y-home axis. You can find this function in two locations. It is found on the toolbar button or under the View Menu.



i *Note: If the selected hoop has a y-offset, this will not represent the center of the hoop even when the hoop center command is used.*

Settings for this feature can be altered by right-clicking on the icon in the toolbar. Settings include whether the origin is displayed as a solid or dotted line, and in what color is it displayed. You can also change where the origin is displayed. It can be displayed at either machine center (default) or the first stitch of the design.

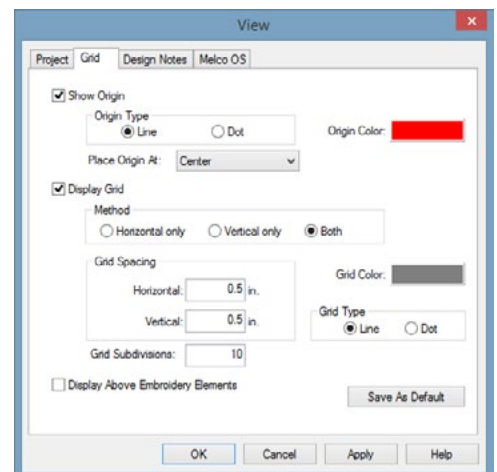
Show Grid

Selecting View>Show Grid will display a grid of horizontal and vertical lines behind the design in the view window. You can find this function in two locations. It is found on the toolbar button or under the View Menu.



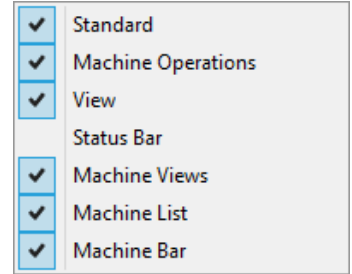
Settings for this feature can be altered by right-clicking on the icon in the toolbar. The settings follow.

- **Method:** Settings include whether the grid contains horizontal lines, vertical lines, or both.
- **Grid Spacing:** This setting controls the distance between the main grid lines. Subdivisions can be specified below.
- **Grid Color:** Select the grid color for the main grid lines.
- **Grid Type:** Specify a solid or dotted grid line.
- **Grid Subdivisions:** Specify the number of subdivision between the main grid lines.
- **Display Above Embroidery Elements:** Check to have the grid appear over the top of the displayed design.



Toolbars ▶

Selecting View>Toolbars will open a fly-out in which a list of available toolbars is shown. Selecting on of these toolbars will show or hide the toolbar. Visible toolbars are display with a check beside them. Hidden toolbars have no check. The toolbars follow.



- Standard: Consists of mostly file options and the help documentation.
- Machine: Contains machine commands and software settings.
- View: Contains zoom tools and view settings.
- Status Bar: Shows information about tools if the tools are hovered over.
- Machine Views: Shows or hides the machine views. This contains the Status, Advanced Status, and Design Queue Tabs.
- Machine List: Shows or hides the machine list that contains all connected and powered machines.
- Machine Bar: Displays information about the machine at the bottom of the screen.

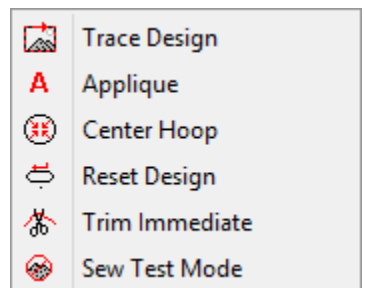
More information can be found in the Toolbars section of this document.

Status Bar

Selecting View>Status Bar toggles the status bar just below the view window. This bar shows information about tools if the tools are hovered over.

Commands Menu

The Commands Menu lists machine commands.



Many of these machine commands move in relation to the selected hoop. It is critical that the selected hoop in the software be the same as the physical hoop that is loaded on the machine.

Trace Design

Selecting Commands>Trace Design will command the machine to initialize the laser and move the hoop arms through the outermost dimensions of the loaded design. This will ensure that the design will fit within the hoop and show where it will be sewn.

Should the design exceed the selected hoop limits, the trace will not be initiated and a prompt will appear stating that the hoop limits have been detected.

You can find this function in two locations. It is found on the toolbar button or under the Commands Menu.



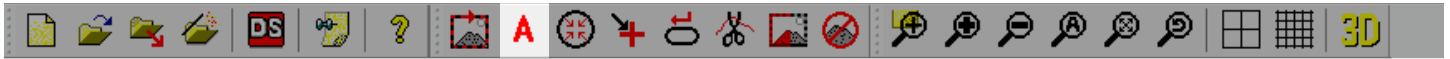
Appliqué

Selecting Commands>Appliqué will move the hoop arms as far forward as possible with the needle still within the hoop limits. In order to use this command, the machine must be stopped and at head up position.

Once the frame has been moved out, a prompt will appear to move it back to the original position.

This command can be useful in accessing the hoop to place appliqué material.

You can find this function in two locations. It is found on the toolbar button or under the Commands Menu.



Center Hoop

Selecting Commands>Center Hoop will initiate a rack movement on the machine to move the hoop arms to hoop center. You can find this function in two locations. It is found on the toolbar button or under the Commands Menu.



Reset Design

Selecting Commands>Reset Design will reset the currently loaded design back to stitch zero. It will reposition the design around wherever the needle is currently positioned in the hoop. You can find this function in two locations. It is found on the toolbar button or under the Commands Menu.



Trim Immediate

Selecting Commands>Trim Immediate will trim the thread immediately. This command is useful if you are doing repair work on a design or if you need to move the hoop and the thread is still in the cloth. You may want to stop in the middle of sewing a design to step back to a stitch in a design. Before you frame back, you can select this command to trim the thread.

When you select this command, a message window will appear, displaying that the machine is about to move. Click on OK to allow the machine to perform the trim command.

You can find this function in two locations. It is found on the toolbar button or under the Commands Menu.



Sew Test Mode

Selecting Commands>Sew Test Mode changes how the machine activity is logged. When this is activated, machine activity is logged as test data instead of production data. You can find this function in two locations. It is found on the toolbar button or under the Commands Menu.



Tools Menu

The Tools Menu contains many sub windows. Many of these are described in separate sections of the document.

Options...

The Options Window contains tabs on preferences, measurement units, barcode options, notifications, and Ethernet settings. Each of these tabs are explained in their respective sections of this document.

Settings...

The Settings Window contains tabs on machine settings, software settings, moving through a design, color sequence, settings by color, thread feed, and maintenance timers. Each of these tabs are explained in their respective sections of this document.

Maintenance...

The Maintenance Window contains tabs on machine information, head timing, steppers, calibration, sensors, and the keypad. Each of these tabs are explained in their respective sections of this document.

Design Filter...

The Design Filter window allows you to make minor adjustments to files as they are loaded to the machine. This window is explained in its own section of this document.

Hoop Setup...

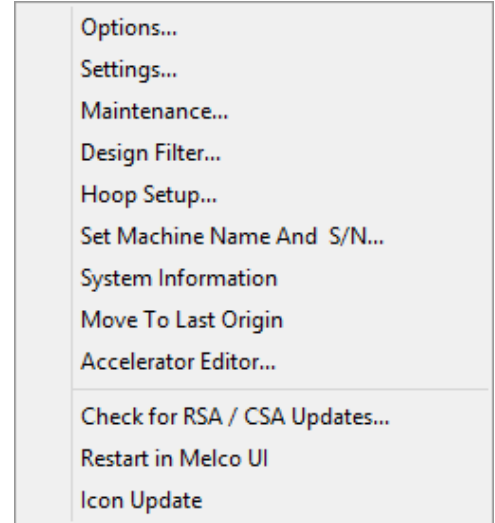
The Hoop Setup window allows you to customize your hoop list to show only the hoops that you own. It also allows you to create a custom hoop. This window is explained in its own section of this document.

Set Machine Name and S/N...

This window walk you through changing the name of the machine or setting the machine serial number. This window is used mostly by technicians in the event of a circuit board being replaced. This window is explained in its own section of this document.

System Information

Selecting Tools>System Information generates a .TXT document on the local drive of your computer listing all the information about your computer and Melco OS settings that a technician may need to diagnose an issues with your machine or software. This is usually only used when prompted by a technician. The file created is labeled "McSysInfo.txt".



Move to Last Origin

Selecting Tools>Move to Last Origin gives you the ability to recover to the exact same starting point of a design origin if for any reason (e.g., power failure) the machine was restarted while sewing a design. The following procedure must be followed for the tool to work correctly.

1. After loading a design, the hoop MUST be centered before sewing.
2. The hoop can then be jogged or moved for alignment purposes.
3. Start sewing the design.
4. If for any reason the machine or the computer must be restarted, e.g., loss of power, restart Melco OS and the machine(s).
5. Load the design and center the hoop.
6. Click on the Tools menu and then click on Move To Last Origin. The machine(s) will move to the last starting position.
7. Frame forward or use the Move to Stitch functions to move forward in the design to the desired starting stitch.

Accelerator Editor...

Selecting Tools>Accelerator Editor brings up a window that allows you to create your own keyboard shortcuts for a number of operations and tools. This window is explained in its own section of this document.

Check for RSA/CSA Updates...

Selecting Tools>Check for RSA/CSA Updates will look to the internet for any new RSA or CSA files for your machine. Should it find them, the files will be loaded to your machine. An internet connection must be available for this function to work.

Security...

The Security Window has information on the dongles, software levels and serial numbers for your software. This window is explained in its own section of this document.

Restart in Melco UI

Selecting Tools>Restart in Melco UI will close the Melco OS Advanced Interface and open the Melco OS User Interface. This provides a faster, cleaner, and simplified work environment for users who do not need all of the extra settings and information provided by the Advanced Interface.

Icon Update

Selecting Tools>Icon Update will open a dialog window for selecting a folder in which to have the icons of the files updated. This will provide icons or thumbnails for files in the file browser.

Tools Menu > Options

Selecting Tools > Options will open a window with several tabs. A description of these tabs follows.

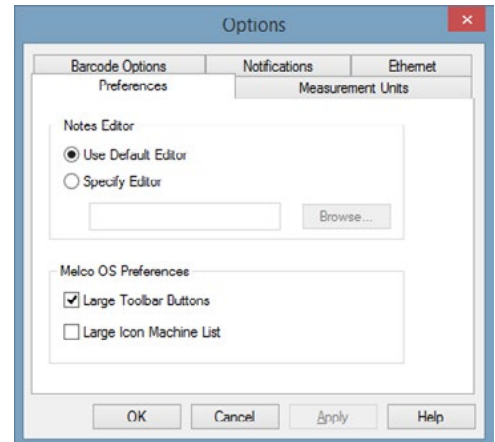
Preferences Tab

Notes Editor

If you choose to use a different editor than the default (Microsoft Word, for example), click in the radio button next to Specify Editor and then browse to the desired editor. Notepad is the default editor.

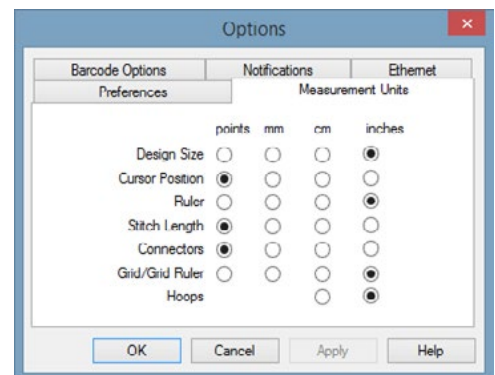
Melco OS Preferences

- Large Toolbar Buttons - If this box is checked, the software will display large toolbar buttons.
- Large Icon Machine List - If this box is checked, the machine list will display large icons.



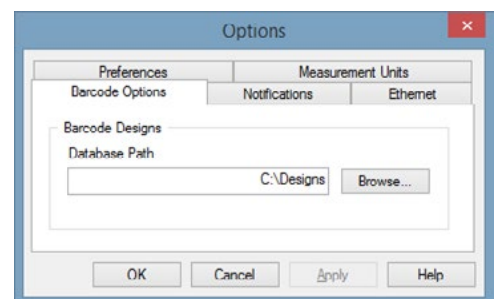
Measurement Units Tab

Use this type to specify the measurement units you would prefer to use for the design size, cursor position, ruler, stitch length, connectors length, the grid and grid ruler, as well as the hoops. The options for measurement units are embroidery points (1/10 of a millimeter), millimeters, centimeters, and inches.



Barcode Options Tab

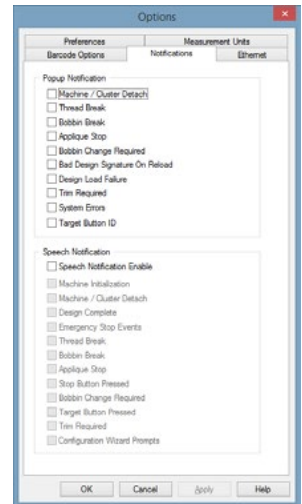
Use the Barcode Option tab to specify the database path for use with the barcode reader. Enter the address of the folder containing the designs to be loaded using the barcode reader. For more information on using a barcode reader to load designs, see the Using Barcodes with Melco OS section of this manual.



Notifications Tab

Select Tools > Options > Notifications tab to select what notifications you want to receive.

The user can choose from multiple banner notifications or from multiple voice notifications. The banner notifications appear as a pop up window on the screen and the speech notifications are played through a speech system for the user to hear. The user must check the box next to Speech Notification Enable before they choose what voice notifications they want to receive. They must also restart the software for the speech notification feature to start working.

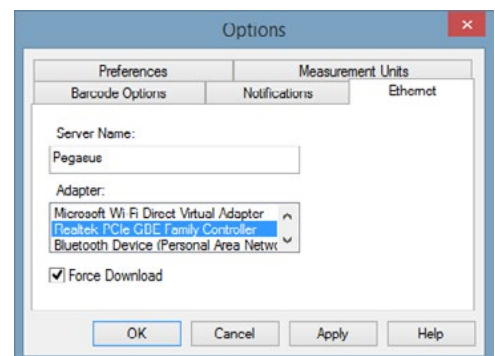


Ethernet Tab

The Ethernet Tab is where the connection to the machine is selected. For additional information about connecting a machine, see the Selecting the Connection section of this document. Server Name - Type the name of your server here. The server name can be any name you choose; it must be 14 characters or less.

Adapter

This lists all known Ethernet adapters in your computer. If more than one adapter is listed here, you will have to select the adapter that is connected to your machine(s). Selecting an adapter is unnecessary for machines with serial numbers of 403291 and later. It may also be unnecessary if the main board of your machine has been replaced.



Force Download (S/N 403290 and earlier)

When this box is checked, the RSA and CSA files on the connected PC are downloaded to the machine when the machine is turned on (the PC must also be turned on for the forced download to occur). Power fail will not work if Force Download is enabled. The design will be reset.

When you turn on the machine without turning on the connected PC, the machine will run the RSA/CSA files that have been previously downloaded from the PC. If the machine does not respond after you have turned it on, you must turn on the connected PC.

When this box is not checked, the download of these files will not be forced unless certain conditions exist when the machine and connected PC are turned on. These conditions are:

- The machine has been without power long enough for the backup capacitor to drain. (This typically takes 3 days).
- The RSA/CSA files have been updated on the PC the machine is connected to.

Tools Menu > Settings

Selecting Tools > Settings will open a window with several tabs. A description of these tabs follows.

Machine Tab

The machine tab contains several machine settings. These settings are described below.

Enable All Thread Detection

When this parameter is turned on, Melco OS will detect thread breaks. If bobbin detection is enabled, Melco OS will also detect when the machine is out of bobbin thread or if there is a bobbin thread break. The default for this parameter is On.

Enable Bobbin Thread Detection

When bobbin detection is enabled, Melco OS will detect when the machine is out of bobbin thread or if there is a bobbin thread break. The default for this parameter is On.

Enable Hoop Limits

This option will prevent the machine from sewing through the selected hoop by checking the frame limits. The default for this parameter is On.



CAUTION!! *If you do not enable hoop limits, you may cause damage to your machine(s) and/or any hoops (including cap frames) that are installed.*

Enable Tie In / Tie Off

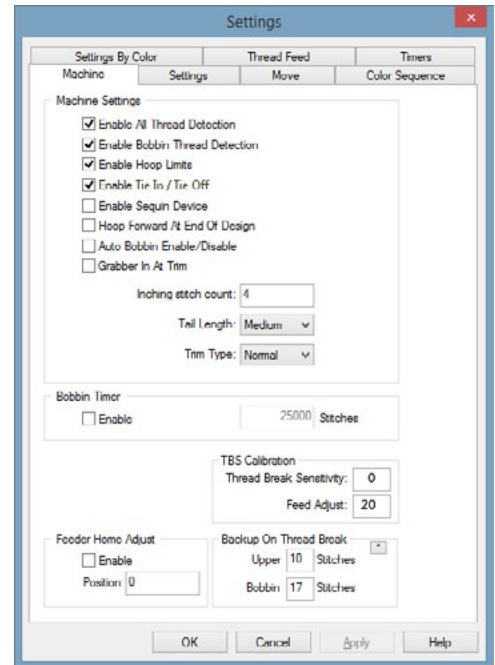
When this option is selected, the tie stitches in the design are replaced by tie stitches optimized for the machine. If no ties stitches are present on either side of a trim, they will be added. If not enabled, tie stitches will appear as digitized in the original design.

Enable Sequin Device

When this option is selected, the machine operates as if a sequin device is present.

Hoop Forward at End of Design

When this parameter is turned on, the machine will push the hoop forward after completing every design. The default for this parameter is Off.



Auto Bobbin Enable/Disable

When this parameter is turned on, and you change from a hoop that is not for caps to a cap hoop, the bobbin detection is turned off. When you change from a cap hoop to a hoop that is not for caps, bobbin detection is turned on.

Grabber in at Trim

If this field is checked the grabber will stay at the "in" position after the trim cycle.

Inching Stitch Count

The quantity of "slow stitches" the machine will make at the beginning of sewing before it goes to full speed.

Tail Length

This parameter (choices are short, medium, and long) refers to the length of thread tail left after a trim. The default is medium tail.

Trim Type

Some machines can be set to trim differently for metallic thread than other threads. When sewing with metallic thread, this parameter should be set to metallic; otherwise it should be set to normal. If you are sewing a design with both metallic and other thread types, you can use Needle Settings on the Settings by Color tab to set the trim type to metallic for specific needles. This is not necessary for all models.

Bobbin Timer

When Enable is checked under the Bobbin Timer feature, the machine will automatically tell you to replace your bobbin when you have reached the number of stitches you specified. Generally, 25,000 is a good number to set for the Bobbin Timer stitch count.

TBS Calibration

The TBS calibration fields allow for the adjust of the sensitivity of the thread break sensor and thread feed.

Feeder Home Adjust

In the small percentage of machines that exhibit clicking when color changing, this feature can be used to alleviate that issue. Read the Thread Feeder Home Adjust section for the full procedure.

Backup On Thread Break

When a break is detected, the machine will back up the specified number of stitches. As bobbin breaks typically take a few more stitches to detect, that number is usually larger. This numbers can be set differently for upper and bobbin thread breaks.

Settings Tab

The settings tab contains several software settings. These settings are described below.

Force Design Return to Origin

When this setting is enabled, the machine will always return to design origin after designs are sewn.

Use Colors from Design

When this parameter is turned on, Melco OS will display loaded designs with the colors stored in the design. This parameter does not affect the color sequence. It merely affects how the design is displayed on screen.

Auto Define Color Sequence

When this parameter is turned on, Melco OS will automatically create a color sequence based on the color information stored in the design and the color information associated with the needles in the thread cone display (displayed in the Color Sequence tab).

For every color number in the design, Melco OS will look for a match to the color in the thread cone display and insert that needle number (cone number) into the color sequence. If there is not a match, then you will be prompted to choose a color from the color palette.

You will not be prompted to choose a color if you have turned on Select Closest Matched Color.

Select Closest Matched Color

This feature is used with Auto Define Color Sequence. If Auto Define is unable to find an exact match, Melco OS will choose the closest color in the thread cone display using the RGB value of that color. When it is unable to find an exact match when automatically defining a color sequence.

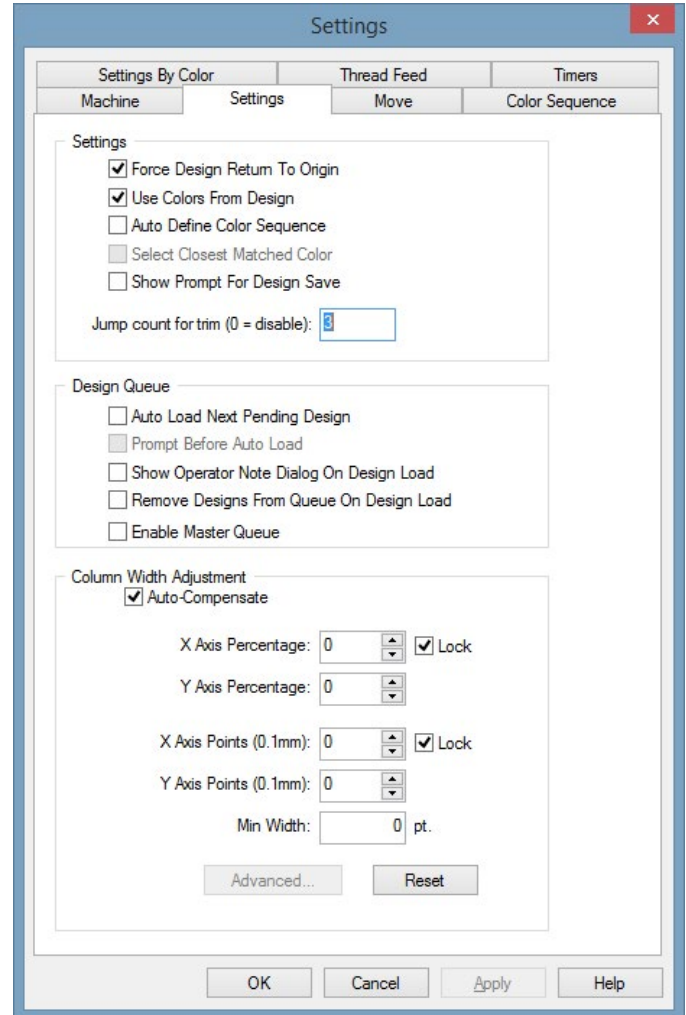
You can only turn on this parameter when Auto Define Color Sequence is turned on.

Show Prompt for Design Save

When this is checked, the user is prompted to save their current design when loading a new design.

Jump Count For Trim

Many stitch files utilize jump stitches instead of trim commands. This feature counts the jumps and converts them to trims. If you adjust this setting, you can adjust when a design utilizing jump stitches will trim.



If more than the specified number or consecutive jump stitches occur in a design, an automatic trim will be executed by the machine. The machine performs the trim before the jump stitches are made. The default value for this is 3. Entering 0 in this parameter disables this feature.

 *Note: You must reload a design for any changes to jump count to take place. That is, if you load a design, then change the jump count, the change will not take place until you reload the design.*

Design Queue Settings

For additional information on using the Design Queue, read the Design Queue section.

(Design Queue) Auto Load Next Pending Design

When this box is checked, the next design in the design queue is automatically loaded into the machine once the desired number of runs have been completed for the current design.

When this box is unchecked, the user must click on the Load button to load the next design into the machine.

(Design Queue) Prompt Before Auto Load

When this box is checked, the software prompts the user with the dialog shown below before automatically loading the next design in the queue. This feature is only available when Auto Load Next Pending Design is turned on. This feature can save you from needing to reload a design at a later time for a repair. The default setting for this feature is Off.

(Design Queue) Show Operator Note Dialog on Design Load

When this box is checked, the Operator Notes dialog is automatically displayed when a new design is loaded. The Operator Notes dialog is only displayed if the design contains operator or design notes. The default for this feature is Off.

(Design Queue) Remove Designs From Queue on Design Load

When this box is checked, designs are automatically deleted from the design queue when they are loaded into a machine. When this feature is turned off, the designs remain in the design queue until they are loaded. The default for this feature is Off.

When Master Queue is enabled, this feature removes the job from the queue after all the number of runs for the job reaches zero.

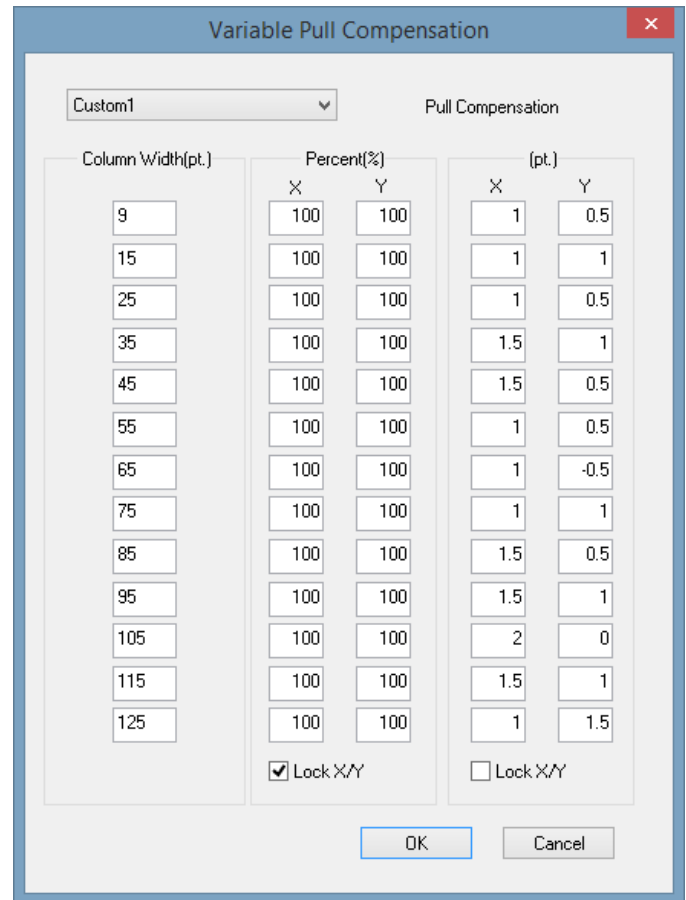
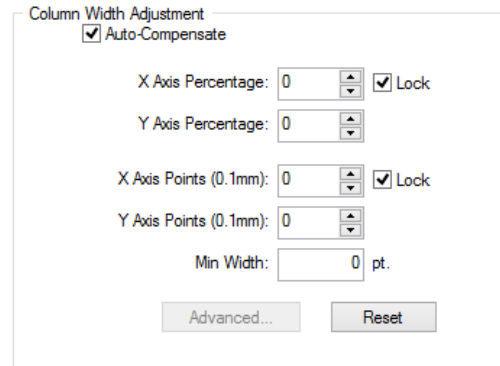
(Design Queue) Enable Master Queue

This check box affects every machine in the machine list. Turning this feature on or off for one machine will do the same for every machine in the machine list. When this box is checked, the Master Queue is enabled for all machines.

Column Width Adjustment Settings

This setting allows you to adjust the width of all columns when they are being sewn. If you have Auto-Compensate selected, the column width values are selected automatically depending on if you are sewing on a cap hoop or a flat hoop. Width can be adjusted manually by percentages (up to 25%) or by points (up to 20; entering points will add or take away points in the column). You can increase or decrease (enter negative values to decrease) column width along the X axis (horizontal stitch direction) and along the Y axis (vertical stitch direction). If Lock is checked, X and Y will both be changed according to the value entered for either X or Y. The default values for all of the settings is zero, which means the column width is not adjusted. The user can specify a minimum width in points for column width so that the columns never sew less than this width. Click the Reset button to restore all of these settings to the default value. Un-check Auto-Compensate and click on the Advanced... button to get the Variable Pull Comp dialog. This allows the user to vary what the pull compensation is for various column widths.

The pulldown menu choices are: Disabled, Custom 1, Custom 2, and 2004 Cap Driver. Change the pulldown menu to Disabled if you want to disable this feature. If you want preset values for a flat hoop, use Custom 1. If you want preset values for a cap hoop, use Custom 2. If you want preset values for a 2004 Cap Driver, use 2004 Cap Driver. The user can then adjust the settings to their specifications.

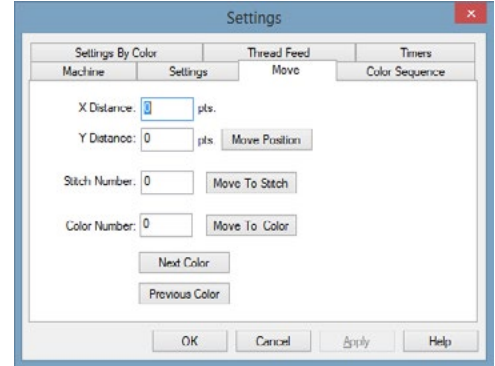


Move Tab

The move tab is used to move the machine to a different hoop position or to a different part of a design. You can move to a specific stitch number, the beginning of a color, or to an XY location.

X Distance and Y Distance

These parameters allow you to move the machine to certain X and Y coordinates. To do this, enter the desired X and/or Y coordinates, and click Move Position. A message window will display stating: Machine is about to move. Click on OK to allow the machine to continue.



Stitch Number

If you want to move the machine to a particular stitch number in the design, enter the stitch and click Move to Stitch. A message window will display stating: Machine is about to move. Click on OK to allow the machine to continue.

Color Number

If you want to move the machine to a particular color in the design, enter the number of the color and click Move to Color. A message window will display stating: Machine is about to move. Click on OK to allow the machine to continue.

Next Color

Click this button to move the machine to the next color in the design.

Previous Color

Click this button to move the machine to the previous color in the design.



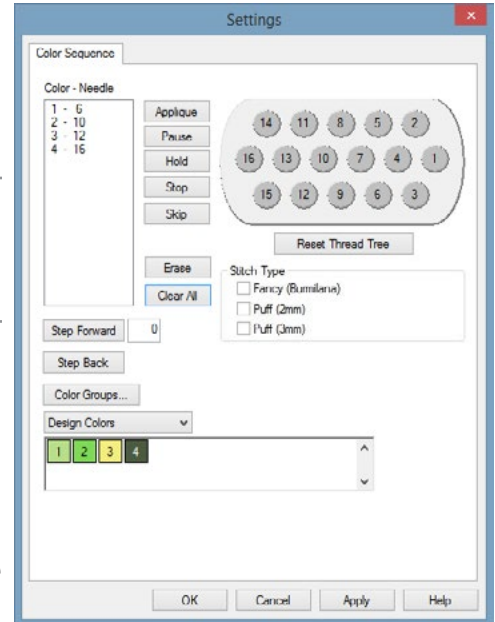
Note: This will move the machine to the first stitch at the beginning of that color in the design.

If you click OK to close this window, when you return to this tab, your previous settings will be saved.

Color Sequence Tab

You can access the color sequence through the menu bar by clicking on Tools > Settings, and then clicking on the Color Sequence tab. This tab is also available by clicking on the Color Sequence button in the Status or Adv Status tab of the Machine Views toolbar.

i *Tip: When you click the Color Sequence button in the Machine Views toolbar, the Settings By Color tab will also be available in the dialog that opens.*



Color - Needle

This area lists the needles in the order in which they are going to sew. The number on the left is the number of the color in the design. The number on the right is the number of the needle on which that color block is going to sew. In the image, the first color to sew will be sewing on needle six. The second color to sew will sew with needle ten.

Step Forward & Step Back

These buttons will allow you to walk through the color blocks in a design. To see this, you may need to move the color sequence tab window so that it is not blocking your view of the design on screen by clicking and dragging on the title bar of the color sequence window.

Pressing Step Forward once will cause the design will grey out and the color number beside it will go to "0". This represents the beginning of the design. Every time the Step Forward button is pressed, another color will appear in the design in the order that it will sew.

Pressing Step Back will cause the colors to grey out again in reverse order. The number beside the step Forward Button represents the latest color in the sequence to appear in color.

Color Groups...

The Color Groups button will open another window. In this new window, needles can be assigned to color groups. This means that multiple needles can have the same color of thread and can be configured to sew if another needle in the color group breaks the thread. In this way you can create back-up colors. For more information, see the Color Groups section.

Thread Cone Display

The thread cone display is a graphic representation of the thread tree on your machine. This is used in setting your color sequence. The first time OS is opened, the thread cone display will show as all grey.

This can be changed to reflect the actual thread colors on your machine. This can be accomplished a couple of ways.



- You can click on any of the design color swatches and drag them up to the thread cone display. This will change the color of the circle, and give that needle the properties of that specific thread.
- Another option would be to right-click on a needle in the thread cone to bring up the Color Properties window. Within this window, you can modify the properties of that color. (See Color Properties).

Reset Thread Tree

The Reset Thread Tree Button will clear any thread colors that have been assigned to the needles in the Thread Cone Display and reset them back to a standard grey.

Design Colors

Design colors displays the color blocks from the design in the order in which they will sew. In the example below, the stitches displayed in red will sew first. The number displayed on the color block represents its position in the sew order. Hovering your mouse over one of the color blocks will pop up the suggested thread color for that block. Notice that the same color may be used multiple times in a design. If that is the case, the color will display each time it is to be sewn. The red, blue, and black in the example below all repeat in the design.

Representative design colors are only saved by a few file formats. OFMs keep design colors. Most other file formats do not.

If a file format does not contain design color information when loaded into Melco OS, it will be given a color for each color block in the file. These colors do not represent the colors in which the design was intended to sew. An example of the default colors give to a design that contains no color information is shown below. This is usually very noticeable from looking at the design on screen. For example, a design of a beach scene without any color information might show up with red water, green sand, and a yellow sky. These are not the colors in which you need to sew. You can choose to sew them in any color you wish.

Setting the Color Sequence with Design Colors

To set the color sequence for a design with Design Colors selected, read the Setting Color Sequence section.

Active Colors

Choosing Active Colors from the drop-down will display each color from the design once. It may be helpful to think of these colors like the cones of thread used in sewing your design. Red may be used several times in a design, but you only require that one cone of that red to be on the machine. Hovering your mouse over one of the color blocks will pop up the suggested thread color for that block.

With Active Colors, needles are assigned to each color block. If that color is used more than once in the a design, Melco OS will use the needle assign to that color block. Color blocks will appear without numbers until a needle is assigned.

Assigning Needles and Setting the Color Sequence with Active Colors

To set the color sequence or assign needles for a design with Active Colors selected, read the Setting Color Sequence Using Active Colors section.

Other Color Sequence Commands

Appliqué

This button inserts an appliqué pause into the color sequence. When the machine encounters an appliqué pause, it pauses and moves the rack out (towards the operator). Press the Start button on the machine to move the rack back in and resume sewing.

See Sewing an Appliqué for instructions on this procedure.

Pause

This button inserts a pause after a color change and commands the machine to wait for an operator restart. The machine will also pause after every following color change and will wait for the operator to restart. To restart sewing after a pause, hit the Start button on the machine. Use this when you want to stop after every color in the color sequence.

Hold

This button inserts a pause after a color change. To resume sewing press the start button. A hold is used most often when a thread color must be changed during a design.

Stop

This button replaces a color change. Inserting a stop does not insert a color change. This command is used most often when an operator wants to insert a manual color change. To resume sewing, press the Start button.

Skip

This button inserts a skip, which cause the machine to skip the next color change and continue sewing on the same needle.


Erase

This button erases the selected color change from the color change sequence.

Clear All

When Design Colors are selected, clicking this button will remove all color sequence information from the Color - Needle field.

When Active Colors are selected, clicking this button once will remove all color sequence information from the Color - Needle field. Clicking it a second time will remove any needle assignments from the active colors.

 *Note: Remember that when Auto Define Color Sequence is turned on, Melco OS will automatically match the colors in the design to colors in the color palette. If there is not a match, then you will be prompted to choose a color. You will not be prompted to choose a color if you have turned on Select Closest Match Color.*

Stitch Type

After a color sequence has been set in the Color-Needle window, the color block may be assigned a stitch type. This is useful for sewing foam or fancy stitch effects.

To use this feature:

1. Select the color to be assigned a stitch type in the Color-Needle window.
2. Check the desired stitch type in the Stitch Type section.
3. An asterisk will appear after the number to indicate that a stitch type has been assigned.

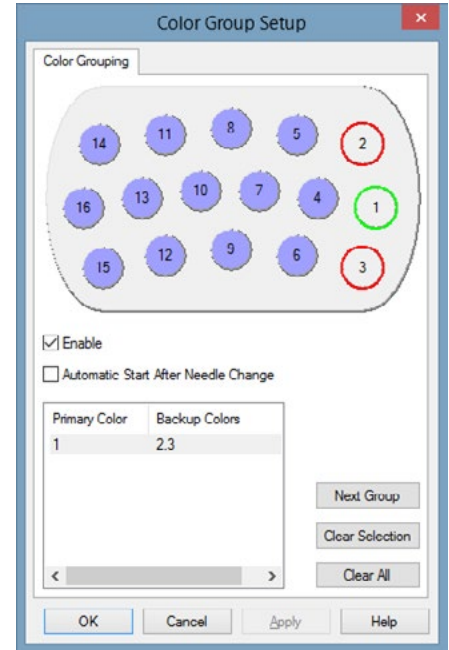
 *Note: No other adjustment to the material thickness needs to be made for that color.*

Color Groups

Color Groups allow you to load multiple cones of the same thread color on different needles. Should there be a thread break, the machine can move to another needle with the same color.

To set up this feature:

1. Click on the Color Group button below the Color-Needle window.
2. In the Color Group window, check the enable box. This will enable the feature, but the color groups must still be specified.
3. Click on the primary needle for your first color in the thread tree. This is the needle that will be able to be selected when setting a color sequence. Once selected, it will appear in the box below as the primary color and the needle in the thread tree will be ringed in green.
4. Next, click on any needles containing the same color of thread as the primary color. This will ring these needles in red and they will serve as backup needles. They will also appear in the box below as backup colors. Backup colors will not be able to be selected when setting a color sequence. They will be greyed out.
5. For additional color groups, click the Next Group button to create a new group and repeat steps 3 and 4 above.
6. Click Apply and OK to complete the group(s) and close the window.



Color Group Options

- Enable - This check box enables the feature.
- Automatic Start - When checked, this will cause the machine to change needles after a thread break and begin sewing on one of the backup needles. When not checked, the machine will still change needles after a thread break, but it will not begin sewing.
- Next Group - This creates a new color group.
- Clear Selection - This button will delete the currently selected color group.
- Clear All - This button will delete all color groups.

Reset Color Group

When the machine has cycled through all of the designated needles for a color, it will stop. You then need to thread up all the needles and reset the machine by pressing the Needlecase key and the Hoop key on the machine keypad.

Reset Color Groups



Needle Case + Hoop: Resets the color group letting the machine know that all needles in the group have been threaded.

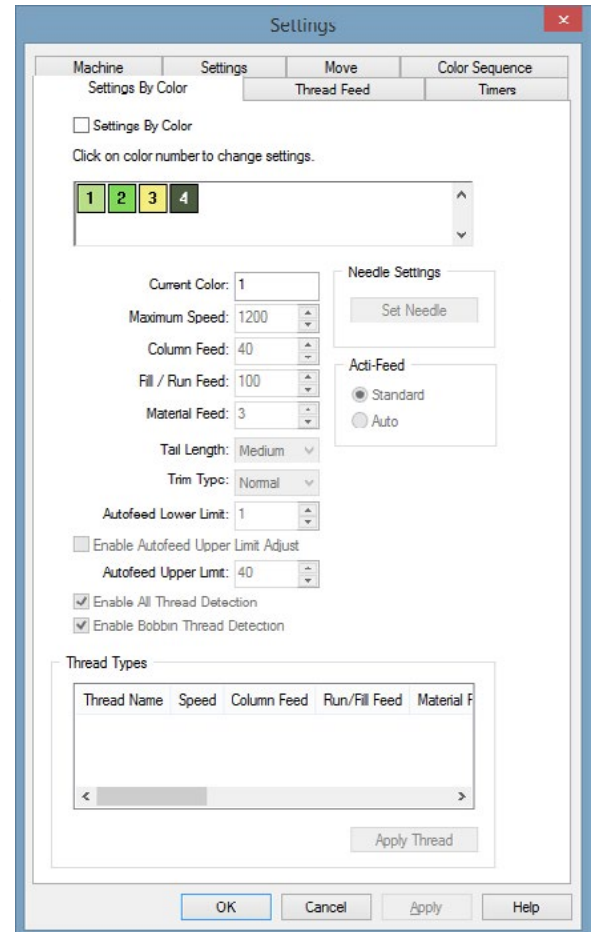
Settings By Color Tab

The Settings by Color tab allows you to change machine settings by design color. Please note that you should set the color sequence for a design before using the Settings by Color feature.

Many of the settings on this tab will be greyed out and unavailable until the feature is enabled by checking the box beside Settings by Color. Please note that if Settings by Color is not enabled, when [OK] or [Apply] is in this tab, any settings by color information will be removed from the current design.

Using Settings By Color

1. To use the Settings by Color feature, perform the following steps:
2. Enable the feature by checking the Settings by Color check box.
3. In the box where the color sequence colors are shown, click on the box of the color number you want to use to change machine settings. Once selected, that color number will display in the Current Color field.
 - Adjust the following machine settings as needed. The following settings are available.
 - Maximum Speed
 - Column Feed
 - Fill/Run Feed
 - Material Thickness - Choose your Acti-Feed settings
 - Tail Length
 - Trim Type
4. The Autofeed Limits are other settings you can change:
 - Autofeed Lower Limit: When in Auto Acti-feed Mode, the material thickness will never go lower than the number specified in this field.
 - Enable Autofeed Upper Limit Adjust: When this is checked, the Autofeed Upper limits become active.
 - Autofeed Upper Limit: Upper limits prevent the actifeed from feeding out more thread than the specified amount.
5. Enable or disable the thread detection.



- Enable All Thread Detection: When this is checked, both bobbin and upper thread are monitored for thread breaks.
 - Enable Bobbin Thread Detection: When unchecked, bobbin thread detection can be disabled independently from the upper thread detection. If unchecked, the bobbin thread will not be monitored for breaks.
6. Steps 2 though 5 can be repeated for each color that require different settings.
 7. When finished, click OK to close the window and apply your changes.

Thread Types

Different thread types may require different settings. For example, metallic thread may require a slower sew speed and a longer tail length to sew well.

When working with Settings By Color, a list of Thread Types appears at the bottom of the window. Each thread type contains predefined settings for the many parameters available on the Settings By Color tab.

To use these predefined thread types, click the box of the color number you want to change, then click the thread type you wish to use, then click the Apply Thread button. The machine settings for the color number you selected will be changed to the predefined settings for the thread type you selected.



IMPORTANT: Please note that these thread type settings are only meant to be used as guidelines. You may need to adjust these settings, depending on the fabric type, design being sewn, etc. After you apply the thread settings to a color number, you can adjust them in the settings area of this tab (this will not change the stored predefined settings). Material Feed will almost always need to be defined either using auto or standard acti-feed as this is not dependent on the thread, but on the material itself.

Creating User-Defined Threads

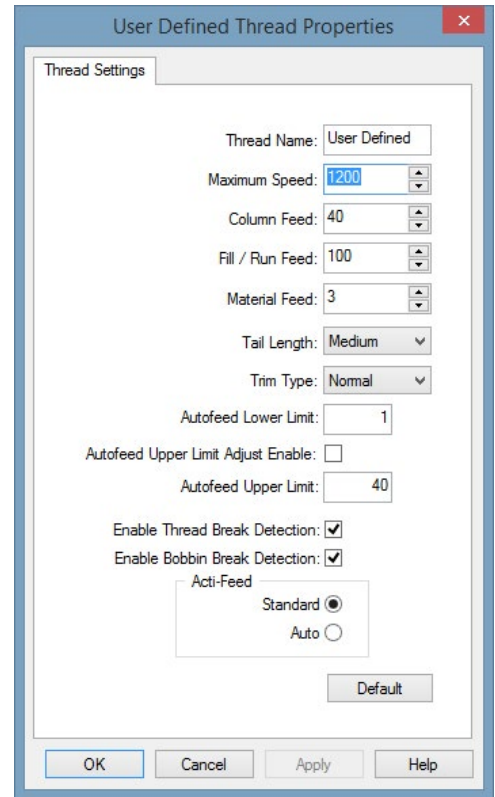
You can also create up to eight user-defined thread types. To do this, under the thread name list, right-click on UserDefined. You will see the following dialog:

Type a thread name, then choose your desired settings for this thread type. Click OK to apply the settings and close the window. The new thread type will appear in the Thread Type list.

Needle Settings

If a design requires the use of a specialty thread such as metallic, and that thread/needle is used multiple times in the design, the settings for that thread can be applied to the needle. When applied to a needle, the settings will be used for every color that uses that needle.

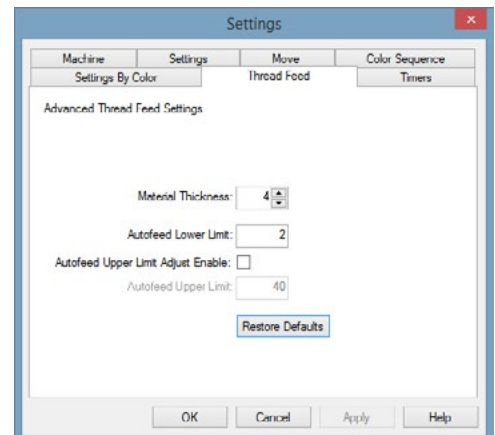
To set Needle Settings, follow the instructions for Settings By Color, but before moving to the next color, click the Set Needle # button (the # will be the number of the needle assigned to that particular color block). For any other color blocks that use that needle, those settings will now be applied.



Thread Feed Tab

Selecting Tools>Settings>Thread Feed Tab is another way of accessing the acti-feed or thread feed settings in your software.

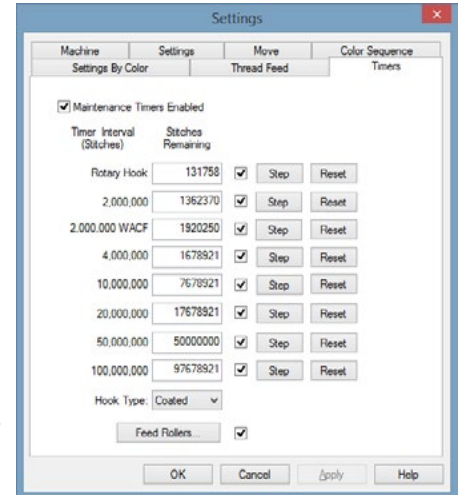
For more information on these settings and how best to use them, reference the Acti-Feed section of this document.



Timers Tab

Selecting Tools>Settings>Timers Tab provides access to the software and machines maintenance timers. These timers are based on the stitch count of the machine and will count down.

As the timers expire, a maintenance timer prompt will appear to remind you to perform the routine maintenance on your machine. This prompt should only appear at the end of a design and never in the middle of sewing.



Maintenance Timers Enabled

If this box is checked, the maintenance timers for your machine will be enabled. This means that you will be prompted by a dialog box at every scheduled interval.



IMPORTANT: *It is highly recommended that you do not disable maintenance timers. These timers are designed to prompt you to perform important maintenance procedures. Neglecting this maintenance could result in damage to your machine.*

Timers

Each timer will have a check box for enabling or disabling individual maintenance timers. This is intended for larger shops that have calendar-based maintenance routine and do not what machine operators interrupted by the more frequent maintenance prompts.

Maintenance Prompts

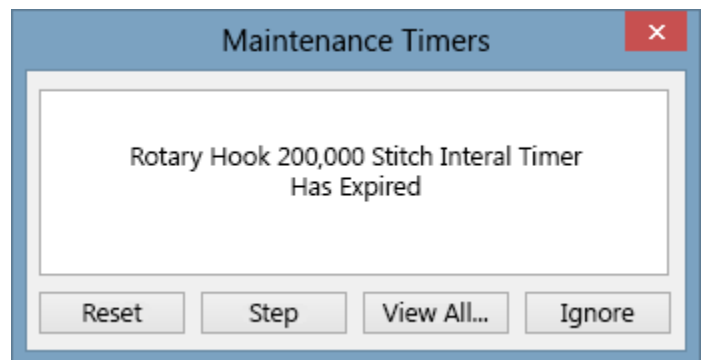
When timers are enabled and expire, a prompt will appear. The prompt will give the options of Reset, Step, View All..., and Ignore.

Reset - Select this if you would prefer to do the maintenance manually.

Step - Select this if you would prefer the software to walk you through the maintenance steps and move the machine to the correct lubrication positions.

View All - Select this to bring up the times tab to see if any other timers and near expiring. This will allow you to group your maintenance down-time more effectively.

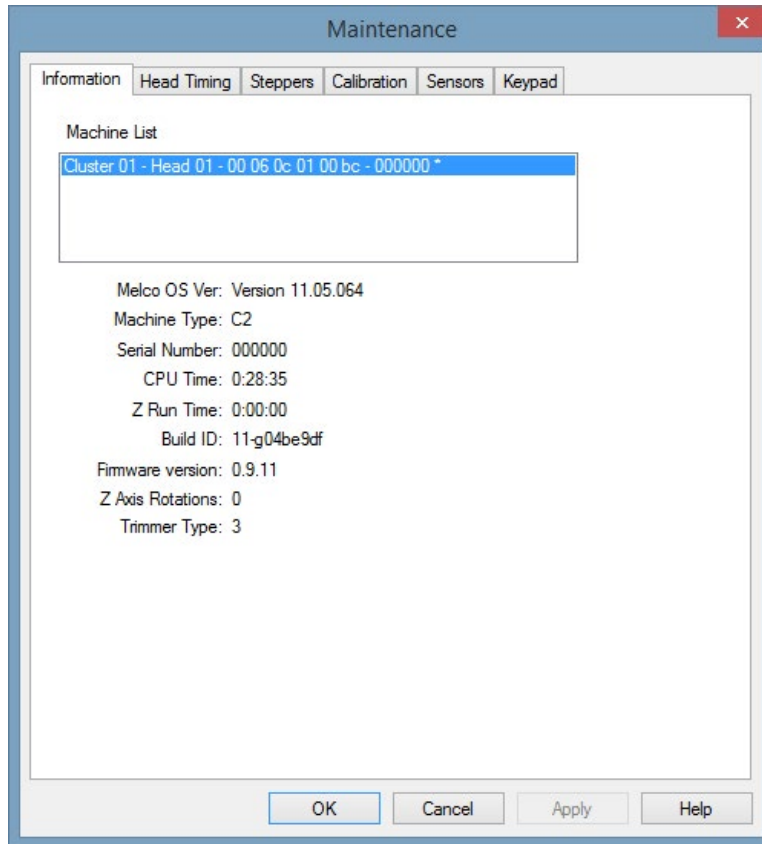
Ignore - Select this to ignore the prompt for one run.



IMPORTANT: *Do not reset a maintenance timer without performing the required maintenance.*

Information Tab

The information tab displays information on the machine(s) that the software is connected to. Information displayed will vary depending on the control board that is installed in the machine.



Head Timing Tab

The Head Timing Tab allows you or a technician to interact with the machine for troubleshooting and maintenance purposes. It is mainly used to move the z-position (in essence, the needle shaft position) of the machine.

Head Up

Head Up position is the position that is sometimes referred to as the z-home position. This will be approximately at 27°.

The machine will return to Head Up when this window is closed.

Top Center

Clicking on Top Center will move the z-position to the top most position. This will display at approximately 0°.

Bottom Center

Clicking on Bottom Center will move the z-position to the bottom most rotation. This will display at approximately 180°.

Hook Timing

Used in setting or examining hook timing, this will most likely only be used when prompted by technical support or the technical manual.

Oil Hook

Clicking on Oil Hook will rotate the hook to the optimal oiling position.

Spin Hook

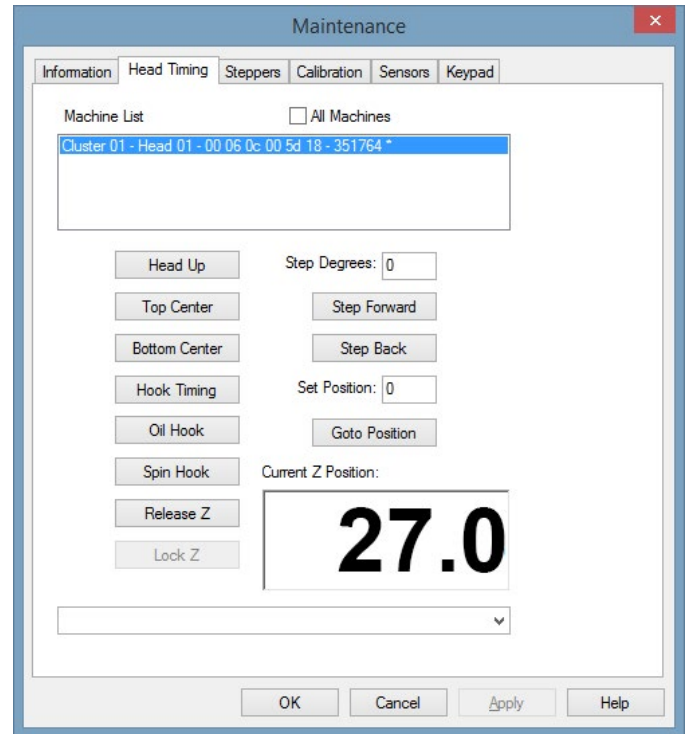
Clicking on Spin Hook will spin the hook quickly. This is often done after oiling the hook to spread the oil.

Release Z

Clicking on Release Z will cut the power to the Z-motor. This will also release the electric lock on the z-position.

Lock Z




Clicking on Lock Z will reinitialize the power to the Z-motor and reengage the electric lock on the z-position.



Head Timing Keypad Functions

When the Head Timing tab is open in the software, several special keypad functions are available. These keypad functions are only available when the Head Timing tab is open. The following table describes these functions.

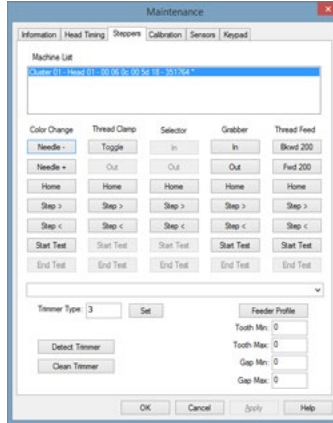
	Go To Head Up Position Adjustment Key + Up Arrow
	Go To Bottom Center Position Adjustment Key + Down Arrow
	Rotate Hook Forward (Approximately 20° increments) Adjustment Key + Right Arrow
	Rotate Z-Axis to 120° (Move needle to just above the needle plate) Adjustment Key + Left Arrow
	Rotate Hook Forward (Approximately 1° increments) Adjustment Key + Up Arrow
	Rotate Hook Forward (Approximately 1° increments) Adjustment Key + Down Arrow
	Micro-step Rotate Hook Forward (Approximately 0.1° increments) Trace Key + Down Arrow
	Micro-step Rotate Hook Backward (Approximately 0.1° increments) Trace Key + Down Arrow
	Shift Needle Case Right (Used for Color Calibration) Trace Key + Right Arrow
	Shift Needle Case Left (Used for Color Calibration) Trace Key + Left Arrow

	<p>Head Up > Bottom Center (Used for Color Calibration)</p> <p>Frame Back Key</p> <p>Always starts at needle one. When this key is pressed once, machine goes to Head Up position twice, then goes to Bottom Center. When the Frame Back key is pressed again, the machine color changes to the next needle, then goes to Bottom Center on that needle.</p>
	<p>Feeder Home Adjust (+) Center + Right Arrow</p>
	<p>Feeder Home Adjust (-) Center + Left Arrow</p>

Steppers Tab

The Steppers Tab is used mostly by technicians. The availability of functions will depend on the machine that is connected to the software. Certain functions only affect legacy equipment or legacy hardware.

If functions are unavailable for the machine or trimmer type, they will grey out.



Color Change

Button	Function
Needle -	Moves the Needle Case to the left one needle
Needle +	Moves the Needle Case to the right one needle
Home	Returns the Needle Case to a home position (moves to the mechanical limit past needle 1)
Step >	Moves Needle Case to the right one motor step
Step <	Moves Needle Case to the left one motor step
Start Test	Begins a color change test
End Test	Ends the color change test

Thread Clamp (Rotary trimmers)

The thread clamp functions change depending on machine and trimmer type. Not all functions are available on all machines. If the function is unavailable, it is not applicable to the connected machine hardware.

Button	Function
Toggle	Activates the thread clamp.

Cutter (XT and ACAT Trimmers)

The cutter functions change depending on machine and trimmer type. Not all functions are available on all machines. If the function is unavailable, it is not applicable to the connected machine hardware.

Button	Function
In	Moves the Cutter to the Home position
Out	Moves the Cutter to the full out position
Home	Moves the Cutter to the Home position
Step >	Moves the Cutter one step out
Step <	Moves the Cutter in step out
Start Test	Begins a functional Cutter test
End Test	Ends the functional Cutter test

Selector

The selector functions change depending on machine and trimmer type. Not all functions are available on all machines. If the function is unavailable, it is not applicable to the connected machine hardware.

Button	Function
In	Moves the selector to the home position
Out	Moves the selector to the full out position
Home	Moves the selector to the home position
Step >	Moves the selector one step out
Step <	Moves the selector in step out
Start Test	Begins a functional selector test
End Test	Ends the functional selector test

Grabber

Button	Function
In	Moves the grabber in (home).
Out	Moves the grabber out
Home	Moves the grabber to the home position
Step >	Moves the grabber one motor step
Step <	Moves the grabber one motor step
Start Test	Begins a functional grabber test
End Test	Ends the functional grabber test

Thread Feed

Button	Function
Bkwd 200	Moves the drive thread feed drive motor backward 200 steps
Fwd 200	Moves the drive thread feed drive motor forward 200 steps (used commonly for the thread feed 200 test)
Home	Moves the thread feed motor to the home position
Step >	Steps the thread feed motor one step forward
Step <	Steps the thread feed motor one step back
Start Test	Starts a thread feed test
End Test	Ends the thread feed test

Trimmer Type

This will display the current software setting for the trimmer type.

- 0 = Non ACA standard XT Trimmer
- 1 = Not Used
- 2 = ACA Trimmer
- 3 = Rotary Trimmer



Changing the trimmer type to a number that does not match the hardware on your machine can result machine damage.

Detect Trimmer

Use the Detect Trimmer button to automatically detect the trimmer type.

Feeder Profile

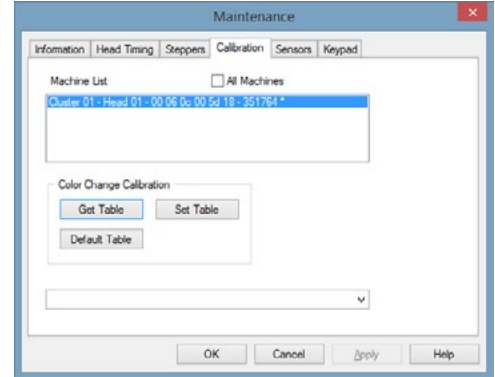
Use the Feeder Profile button to rotate the thread feed motor one full revolution to analyze the tooth profile of the drive gear and populate the fields below the button.

Calibration Tab

The calibration tab is used for calibrating the color change table. Essentially this is the information that keeps all of the machine needles in the center of the hole in the needle plate. If this calibration is off, it can cause thread breaks and needle breaks.

Get Table

The Get Table button pulls the calibration table from the machine and saves it in the computer. This is useful if you want to keep the table when a circuit board is replaced.



Set Table

The Set Table button pushes the table from the computer to the machine.

Default Table

The Default Table button sets the calibration table back to the factory defaults. This is a general table and is not meant to be sewn with. It is merely a starting point for the calibration process.



Warning! Do not sew with a default table. The default setting is a default table that is an approximation and is intended as a starting point for manually setting the color change table.

Color Change Calibration Procedure

There is a table in the machine that tells the machine the position of each needle. Each needle on your machine must be in the center on the hole in the needle plate. Perform the following steps to calibrate your color change table, please read through the whole procedure before taking any actions.

1. Color Change to needle 1.
2. Select Tools>Maintenance>Calibration Tab - from here you can GET or SET the color change table.
3. Go into the Head Timing Tab.
4. Press the Adjustment and Arrow Down keys on your machine keypad. This is also Bottom Center on your Head Timing Tab.
5. Check to see where your needle is. It must be in the exact center of the hole on your needle plate.
6. If the needle is not correctly lined up, you must raise the needle up and use the Trace and Arrow Left or Arrow Right keys on your machine keypad to align the needle.
7. Drop the needle down again to see if it is centered. Repeat the above steps until it is.
8. Color change to the next needle and repeat the steps for all 16 needles.
9. Go back into the Calibration Tab and select Get Table to save the color change calibration to the software.

Sensors Tab

The Sensors Tab contains information on the state of the sensors in the machine.

X-Axis Count

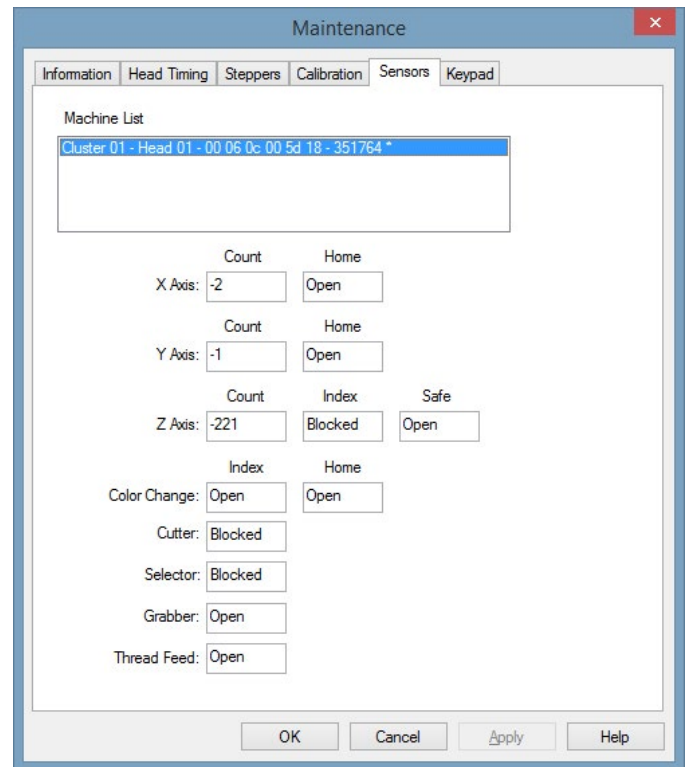
The X-Axis Count Sensor provides information on the current rotational position of the X servo motor. This motor is responsible for the left/right (X Axis) motion of the machine carriage.

X-Axis Home

The X-Axis Home Sensor provides information on the current STATE or STATUS of the motor relational to an optical sensor that reports either BLOCKED or OPEN. In addition this status is used by the machine during initialization and hoop center commands.

Blocked = The carriage is left of center

Open = The carriage is right of center



Y-Axis Count

The Y-Axis Count Sensor provides information on the current rotational position of the Y servo motor. This motor is responsible for the forward/back (Y Axis) motion of the machine carriage.

Y-Axis Home

The Y-Axis Home Sensor provides information on the current STATE or STATUS of the motor relational to an optical sensor that reports either BLOCKED or OPEN. In addition this status is used by the machine during initialization and hoop center commands

Blocked = The carriage is positioned rear of center

Open = The carriage is positioned forward of center

Z-Axis Count

The Z-Axis Count Sensor provides information on the current rotational position of the Z servo motor. This motor is responsible for the up/down (Z-Axis) motion of the needle.

Z-Axis Index

Z-Axis Index Sensor provides the index pulse needed for machine initialization and is used during sewing operation to coordinate carriage motion with needle motion.

Blocked = 0 - 180 degrees of current Z position

Open = 181 - 359 degrees of current Z position

Z-Axis Safe

The Z-Axis Safe Sensor provides information to the machine related to color change operations.

Blocked = Not at HEADUP

Open = Normal idle state at HEADUP

Color Change Index (Some models only)

Blocked = Not on needle center

Open = Machine recognizes that a needle is currently positioned at center (Note: This assumes proper needle calibration and should not be used to determine if a needle is correctly centered)

Cutter (Some Models Only)

The Cutter Sensor provides information on the current STATE or STATUS of the motor relational to an optical sensor that reports either BLOCKED or OPEN.

Blocked = XT - not at home / XTS - Home

Open = XT - Home / XTS - not at Home

Selector (Some Models Only)

The Selector Sensor provides information on the current STATE or STATUS of the motor relational to an optical sensor that reports either BLOCKED or OPEN.

Blocked = XT - not at home / XTS - Home

Open = XT - Home / XTS - not at Home

Grabber

The Grabber Sensor provides information on the current STATE or STATUS of the motor relational to an optical sensor that reports either BLOCKED or OPEN.

Blocked = Not at Home

Open = Home

Thread Feed

The Thread Feed Sensor provides information on the current STATE or STATUS of the motor relational to an optical sensor that reports either BLOCKED or OPEN. For additional information see the Technical Manual.

Keypad Tab

If you are experiencing problems with your keypad, you may want to perform a keypad test. A keypad test will tell you if the keypad is communicating with your machine.

Use the Keypad Tab in the Maintenance window to perform a keypad test.

Keypad Buttons

When a key on the keypad is pressed, the corresponding button turns bright pink if the keypad is functioning properly.

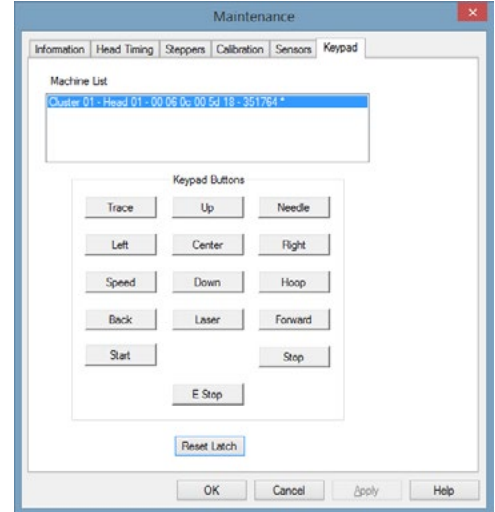
When the corresponding key on the keypad is released, the button turns back to grey, but the font color of the button changes to yellow if the keypad is functioning properly.

If none of these buttons change color, that indicates a problem with either the user interface harness, a loose connection, or a problem in the Main PCB.

The first button pressed while this screen is visible puts the keypad in test mode.

Reset Latch

Press to reset keypad latch on the Main PCB (this basically resets Test Mode).



Design Filter

Selecting Tools>Design Filter accesses the design filter settings. These settings will filter a design upon design load. To utilize these filters, check to box to the left of the desired filter.

Accumulate Jump Stitches

When you digitize a jump stitch between two points, the computer makes the move in increments of the stitch length you are using. For example, if the total distance you are moving is 360 points, and your stitch length is 40 points, then the computer will generate 9 stitches (in the jump stitch mode) to cover that distance.

By turning this function ON, you will force the computer to cover the 360-point distance in increments of the maximum stitch length for the format you are using.

Assuming we are using a format with a 127-point maximum stitch length, then the computer would generate only 3 stitches to cover the 360 point movement. This would decrease the design's stitch count, and save a little sewing time.

Accumulate Short Stitches

This function will delete all short stitches that are equal to, or less than, the length that you set in Short Stitch Length. This function will filter out a series of short stitches; therefore, if you desire to protect your lock stitches, you must enter the number of consecutive short stitches that you want to protect in the After Short stitch count box.

The box below Accumulate Short Stitches, labeled After Short, is the short stitch count. This function is used in conjunction with Accumulate Short Stitches and allows you to determine the number of consecutive short stitches that will not be deleted when you use the Accumulate Short Stitches function. You may enter any number up to and including 20 stitches.

Delete Single Short Stitches

This does not refer to your column stitches, but rather those zero-motion or tiny walk stitches that are sometimes in designs. There are also some very tiny stitches in the fills that are digitized when the needle begins sewing a new line of stitch.

This function will only delete a single short stitch, that is, a short stitch that is preceded by, and followed by, a stitch that exceeds the length defined in Short Stitch Length. Two or more consecutive short stitches will not be affected by this function. This function allows you to filter out any random short stitches without filtering out your lock stitches.

Maximum Stitch Length

Any stitches greater than this value will be broken down with intervening jump stitches by the computer.

Short Stitch Length

This function allows you to enter a length, from 0 to 10 points, that defines what a short stitch is. For example, if you enter a length of 3 points; then any stitch that has a length of 3 points or less will be considered a short stitch, and will be acted upon by the other short stitch functions.

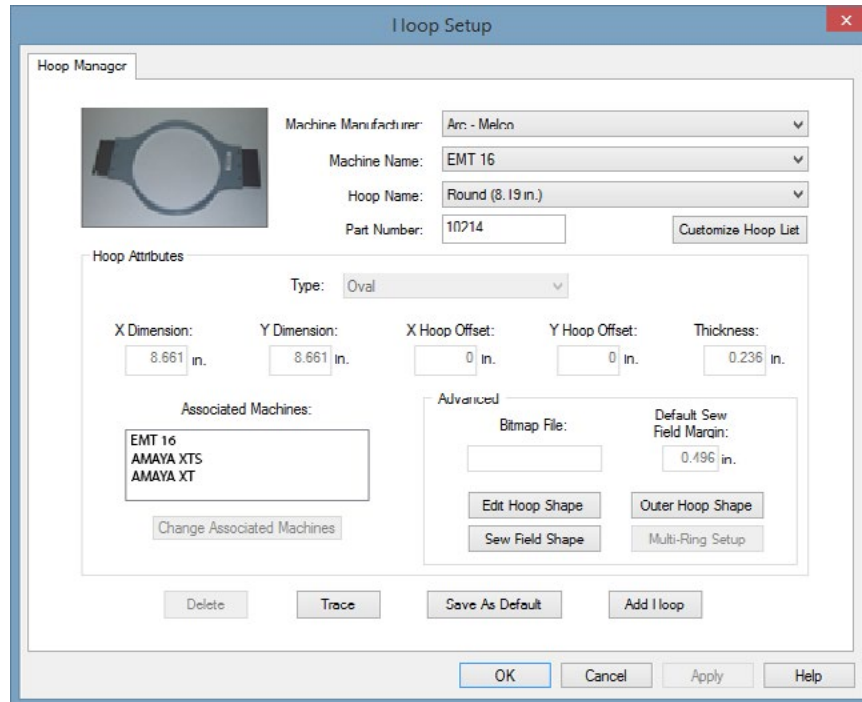
Filter and Adjust Now

Click this to apply your changes.

Hoop Manager (Hoop Setup)

Selecting Tools>Hoop Setup will access the Hoop Manager. The Hoop Manager allows you to view information on the predefined hoops commonly used with your machine and other embroidery machines. The Hoop Manager also allows you to create user-defined, custom hoops.

i **NOTE:** With your machine type set to Amaya, some hoops are turned off. To see all hoops, go to the Customize Hoop List button and turn the hoops on.



i **Tip:** You have the option of changing the measurement units displayed by the Hoop Manager. To do this, select Tools->Options, then click the Measurements Units tab. Here you can select inches or cm for Hoops.

Predefined Hoops

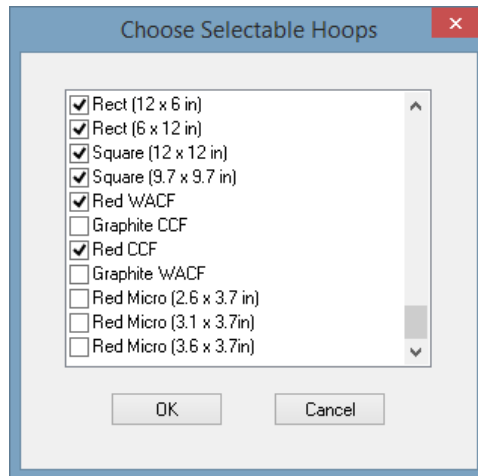
The Hoop Manager stores and displays the following information about predefined hoops. This information cannot be changed.

Machine Manufacturer: The Machine Manufacturer list displays several embroidery machine manufacturers. (Click the pull-down arrow to display the list, then left-click a manufacturer to select). The selected manufacturer will determine which machines are shown in the Machine Name list.

Machine Name List: The Machine Name list displays the machines produced by the selected manufacturer. For example, your machine name will only appear in the Machine Name list when ARC - Melco

is selected as the manufacturer. (Click the pull-down arrow to display the list, then left-click a machine name to select). The selected machine will determine which hoops are available in the Hoop Name list.

Hoop Name: The Hoop Name list displays which hoops are associated with the selected machine. To change which hoops are displayed in this list, click the Customize Hoop List button (located directly under the Hoop Name pull-down menu). This will display the following dialog:



When the check box next to a hoop name is checked, the hoop will be displayed in the list. To hide a hoop name in the list, uncheck the hoop's corresponding check box. When you click OK to close the dialog and display your changes, the hoop will not be visible in the list. To display a hoop that has been hidden, simply check its corresponding check box in this dialog.



NOTE: The 15cm / 5.9 inch hoop will not be available in this dialog because it is the default displayed hoop.

Part Number: This shows you the part number of the hoop you have selected.

Hoop Attributes

When a hoop is selected (click the pull-down arrow to display the list, then left-click a hoop name to select), that hoop's attributes will be displayed. These programmed dimensions will be grayed out; this information cannot be changed.

- Hoop Type: the type of the selected hoop (rectangular, circular, square, etc)
- X Dimension: the width of the hoop from left to right (measured from the outside edge of one side of the inner hoop to the outside edge of the other side of the inner hoop)
- Y Dimension: the height of the hoop from top to bottom (measured from the outside edge of one side of the inner hoop to the outside edge of the other side of the inner hoop)
- X and Y Offset: the distance from the machine origin to the hoop center
- Hoop Thickness: the width of the outside edge of the hoop wall to the inside edge of the hoop wall

After selecting a hoop, you can click the Trace button and Melco OS will trace your design and give you a message that tells you whether or not your design fits in the selected hoop

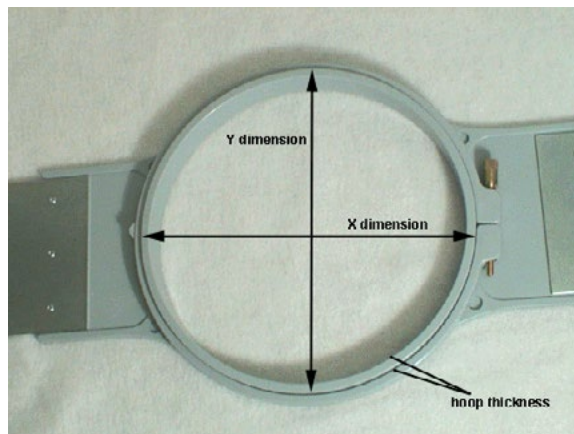
i *Note: The hoop that is selected in the Hoop Manager does not change the hoop selected in the Melco OS Hoop Selection menu. (Unless you click the Save As Default button to save the selected hoop as the default hoop in Melco OS. The next time you open Melco OS, this hoop will be the selected hoop in the Hoop Selection menu (and will be displayed in the View Window).*

Click OK to close the Hoop Manager dialog.

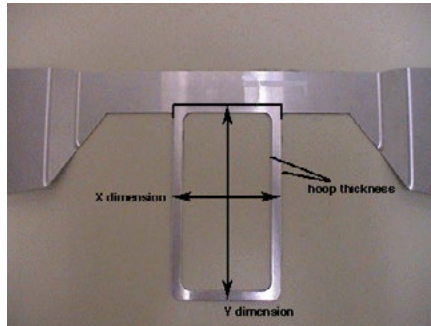
User-Defined Hoops

Complete the following steps to create a custom hoop in the software.

1. Make sure your machine is selected in the Machine Name pull-down menu (Arc - Melco must be selected as the Machine Manufacturer).
2. Click the Add Hoop button in the Hoop Manager window. Type in a name for the new hoop and click OK.
3. Select a hoop shape from the Hoop Type pull-down menu.
4. Enter the attributes of the new hoop in the Hoop Attributes area.
 - Hoop Type: the type of the selected hoop (rectangular, circular, square, etc.)
 - X Dimension: the width of the hoop from left to right. This measurement should be from the outside edge of one side of the inner hoop to the outside edge of the other side of the inner hoop (see image below).
 - Y Dimension: the height of the hoop from top to bottom. This measurement should be from the outside edge of one side of the inner hoop to the outside edge of the other side of the inner hoop (see image below).
 - Hoop Thickness: the width from the outside edge of the inner hoop to the inside edge of the inner hoop (see image below). If you do not enter a hoop thickness, the Hoop Manager will use a default thickness of 65 points.



i **NOTE:** Some hoops (such as Fast Frames) consist of a single frame rather than an inner and outer hoop. To measure the hoop thickness of this type of hoop, measure the thickness of the frame as shown in the example hoop below. To obtain the X dimension, measure the outer edge of the frame horizontally (left to right). To obtain the Y dimension, measure vertically (top to bottom) as shown in the following image. Notice that the Y dimension is not measured to the edge of the bracket.



- X and Y Offset: the distance from the machine origin to the hoop center. It is necessary to enter offsets when the hoop center is not aligned with the machine origin (the needle plate hole). Offsets will align the hoop center to the machine origin. Please note that you will not always need an X and Y offset; for example, in many cases, only a Y offset is needed.

To measure for offsets, you must first select a predefined hoop (e.g., 15cm) from the Hoop Selection menu, then click the Hoop Center button. Then attach the hoop you are defining to your machine.

To measure for the X offset, measure the horizontal distance (in inches) from the hoop center to the needle plate hole. If you need to move the hoop center to the left (your left as you face the machine), enter a negative number for this value.

To measure for the Y offset, measure the vertical distance (in inches) from the hoop center to the needle plate hole. If you need to move the hoop center toward the machine, enter a negative number for this value.

5. After you enter the hoop attributes, the Hoop Manager will have the information needed to create the new hoop. Click OK to save your changes and close the Hoop Manager dialog. The new hoop will now be available from the Hoop Selection menu.

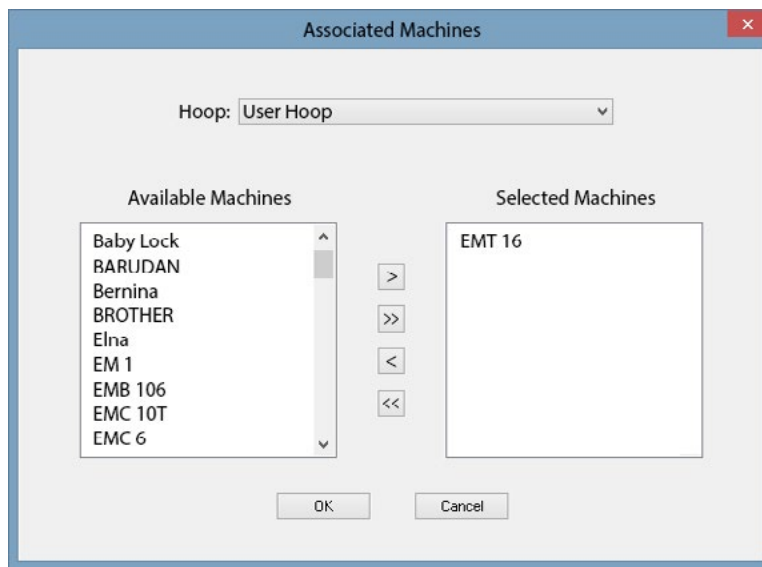
When the hoop is displayed in the View Window (the hoop will be displayed when selected in the Hoop Selection menu), you will see two solid lines and a dashed line.



The outer solid line represents the outer edge of the inner hoop (drawn based on entered X and Y dimensions). The inner solid line represents the inner edge of the inner hoop (the Hoop Manager determines this by doubling the hoop thickness, then subtracting this from the X and Y dimensions). The dotted line represents the sew field for the defined hoop. The Hoop Manager determines the sew field from the value in the Default Sew Field Margin box. If you have not changed this value, the sew field will be 126 embroidery points (approximately 0.50 inches) from the inner edge of the inner hoop (the inner solid line). You can change this to any desired value, and this value will be saved with the hoop.

Additional Settings

Associated Machines - To change the machine(s) associated with the new hoop, click the Change Associated Machines button in the Hoop Manager Properties dialog. To select a machine, left-click the machine name, then click (>). [To select all machines click (<<)]. Click OK when you are finished selecting machines.



You can enter an image file name (in the Bitmap File box) if you have an image of the new hoop. This image will be displayed in the main Hoop Manager window. (The ideal size for this image is 1.3 inches wide x 0.82 inches tall). After you type the name of the image in the Bitmap File box, copy the image file into the following directory (Melco OS Install Directory\System\Bitmaps).

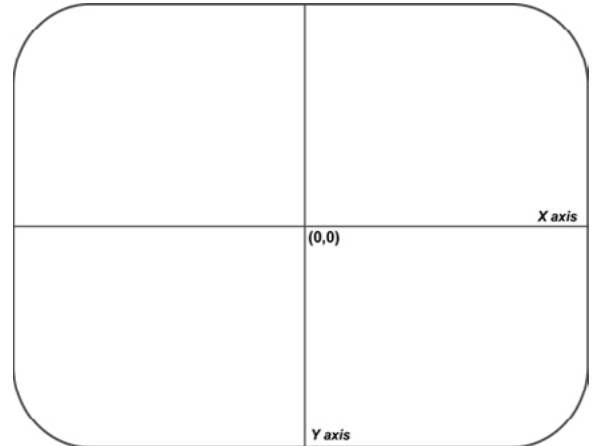
Click OK or Apply when you have completed your changes.

Custom Hoop Shape

When creating a custom hoop, the shape of your hoop may not be available from the Hoop Type menu. If it is not, you will need to create a custom hoop shape. In our example, we will create a rectangular hoop with round edges that is 11 x 8.5 inches (28 x 22 cm). To create a custom hoop shape:

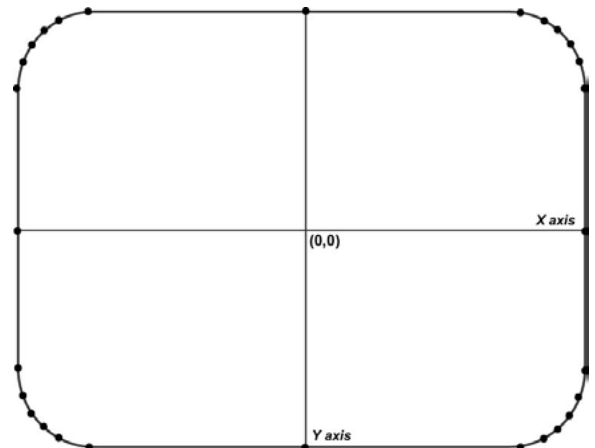
1. Creating a custom hoop shape involves entering a list of points that will define the shape in the Hoop Manager. Before you open the Hoop Manager, you can determine these points.

The easiest way to obtain these points is to trace your hoop on a piece of paper. When tracing, trace around the outer edge of the inner hoop. After tracing, draw a vertical line to split the hoop exactly in half vertically (this will be the Y axis). Next, draw a horizontal line to split the hoop exactly in half horizontally (this will be the X axis). The point where the two lines cross will be the hoop center (0,0). (See the following image, which displays the traced outline of our example hoop).



2. Now you need to determine the points you are going to enter in the Hoop Manager. On the traced hoop, draw up to 32 points all the way around the hoop. You must place a point at any location where the X/Y axes intersect with the hoop outline (see the following image).

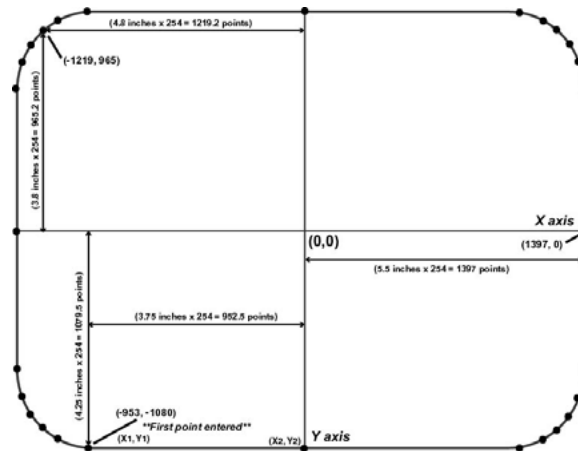
The more points you choose to enter, the smoother the drawing of the hoop will be onscreen. Try to place as many points as you can on any curved areas of your hoop. (The following image displays 28 points selected to enter for our example hoop. Notice how most of the points are **clustered** at the curves of the hoop).



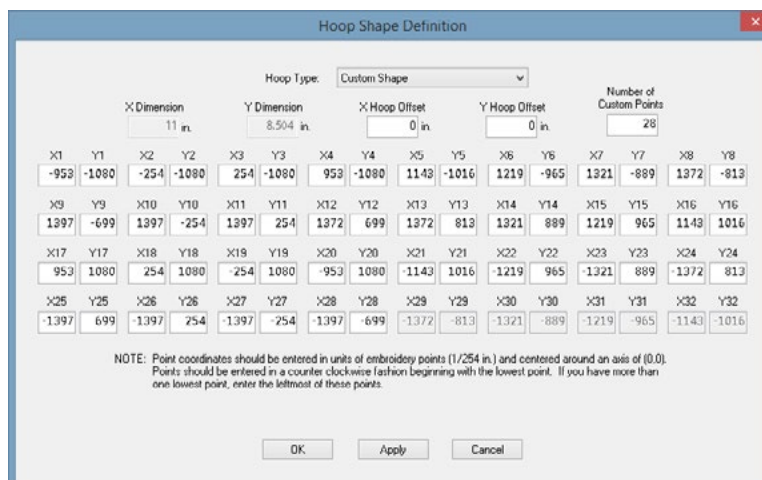
3. Now you need to measure the distance from each point to the hoop center. You can take these measurements in inches or centimeters. For each point you will need to take two measurements: the horizontal distance from the hoop center (0,0) and the vertical distance from the hoop center. Note that the closer the points are together, the more exact your measurements should be.

Once you have these measurements, you will need to determine the coordinates of each point in embroidery points. For the X coordinate, multiply the horizontal distance by 254 if measured in inches or by 100 if measured in centimeters. If the point is to the left of the hoop center, the coordinate will be a negative number. Repeat this for the Y coordinate (vertical distance). If the point is below the hoop center, this coordinate will be a negative number. After calculating the embroidery points, round them to whole numbers. You will now have the coordinates needed to enter in Hoop Manager.

See the following image for examples of these measurements (note that distances were measured in inches).



4. Click the Add Hoop button in the Hoop Manager Properties dialog. Enter a name for the new hoop and click OK.
5. Click the Edit Hoop Shape button. You will see the Hoop Shape Definition dialog.
6. In this dialog you will enter points to plot the shape of your hoop. After you have calculated all of your points, you can enter them in the Hoop Manager. In the Hoop Shape Definition dialog, select Custom Shape from the Hoop Type pull-down menu.
7. In the Number of Points text box, type the number of points you will be entering. Once you type this number, the coordinate text boxes will no longer be grayed out.
8. You can now type in the coordinates of your points, beginning with the lowest point (type this point in the X1 and Y1 boxes). If you have more than one lowest point, enter the point that is farthest to the left. (The first point of our example hoop is indicated in the above image. After entering the first point, proceed in a counter-clockwise direction around the hoop and enter the remaining points.
9. The following image displays all of the points of our example hoop typed in the Hoop Shape Definition dialog.



After you enter all points, click the Apply button.

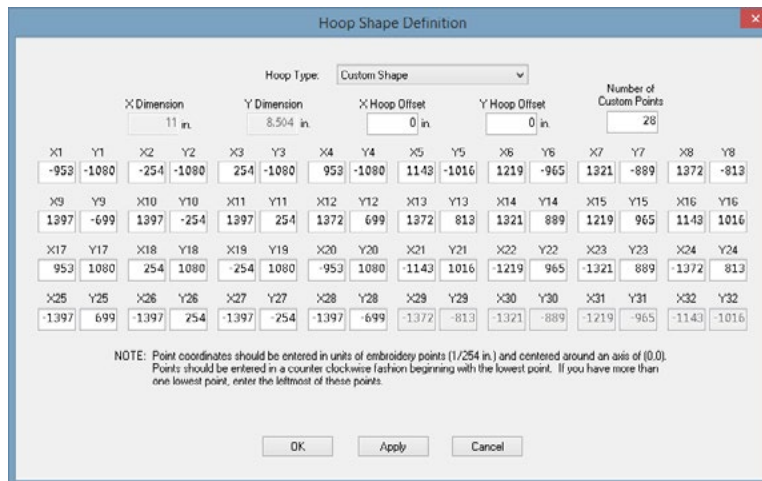
The Hoop Manager will notify you if the shape is invalid. For example, you will receive an error message if your shape does not form a convex polygon (the hoop must be a convex polygon, that is, none of the sides can be dented inward). If you received an error message, check your points to make sure you entered them correctly.

Click OK to close the Hoop Shape Definition dialog.

Your custom hoop with custom hoop shape will now be available in the Hoop Manager (and from the Melco OS Hoop Selection menu).

Custom Sew Field Shape

As mentioned above, the Hoop Manager will determine the sew field from the value in the Default Sew Field Margin box (the sew field takes the shape of the defined hoop). If you wish to change the sew field, click the Sew Field Shape button in the Hoop Manager Properties dialog. You will see the following window:



In this window, you can either select a predefined sew field shape or create a custom sew field shape. To select a predefined sew field shape (based on hoop types), select the type from the Hoop Type menu (e.g., circular in the above image). To specify the sew field size, enter the X Dimension (sew field width), Y Dimension (sew field height) and X and Y Offsets (the vertical and horizontal distances from the sew field center to the hoop center).

You can also enter points to create a custom sew field shape. To do this, use the same procedure used to create a custom hoop shape. (See Custom Hoop Shape for the procedure).

Clicking the Reset to Default Sew Field Value will reset the sew field to the value on the Hoop Manager Properties dialog. (See Default Sew Field Value).

When finished, click Apply. You will receive a message if your sew field is not valid.

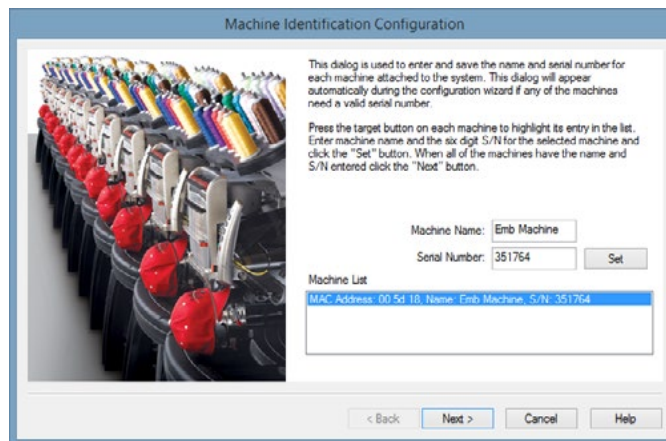
Set Machine Name & S/N

Selecting Tools>Set Machine Name and S/N will bring up the Machine Identification Configuration screen. This screen can also be accessed from the Configure Button at the top of the Machine List.

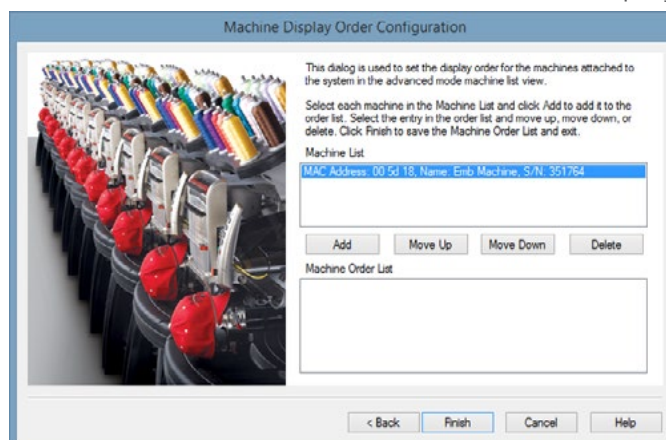
This screen will allow you to rename and change the order of the machines you currently have connected to the software. The on screen instructions will walk you through the process. These same steps are listed below.

To change the name or the order of machines listed in the Machine List View:

1. Click the Configure Button from the Machine List View or go to Tools>Set Machine Name and S/N. You will be taken to the Machine Identification Configuration.



2. From the Machine Identification Configuration window Machine List click on the first machine you wish to modify.
3. After clicking on the machine you wish to modify you can:
 - a. Rename the machine by typing in the field next to "Machine Name" - click on Set to make your changes permanent
 - b. Change the serial number by typing in the field next to "Serial Number" - click on Set to make your changes permanent
4. Click Next to continue. You will see the screen called Machine Display Order Configuration.

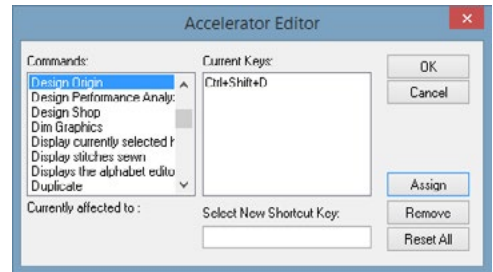


From the Machine Display Order Configuration window you can:

- Change the order of machines by clicking on the machine you wish to add to your list and then click add.
- When a machine is selected in the Machine Display Order Configuration window you can click on Move Up or Move Down to move the machine up or down in the list order.
- When a machine is selected, clicking on Delete will remove the machine from the list.
- Clicking on the < Back button will return you to the Machine Identification Configuration window.
- Clicking on the Finish button will save all of your changes and return you to the main screen.
- Clicking on Cancel will cancel any changes you have made and return you to the main screen.

Tools Menu > Accelerator Editor

Selecting Tools>Accelerator Editor brings up a window that allows you to create your own keyboard shortcuts for a number of operations and tools.



To setup a shortcut:

1. Select the function that you want to accelerate from the Commands window
2. After clicking on the command you wish to edit, click > in the field Select New Shortcut Key
3. Press the key stroke combination you wish to use to activate your selected command
4. Click the Assign button.
5. Click the OK button.

To remove a shortcut:

1. Select the function that you want to accelerate from the Commands window
2. Click the Remove button

To restore system defaults:

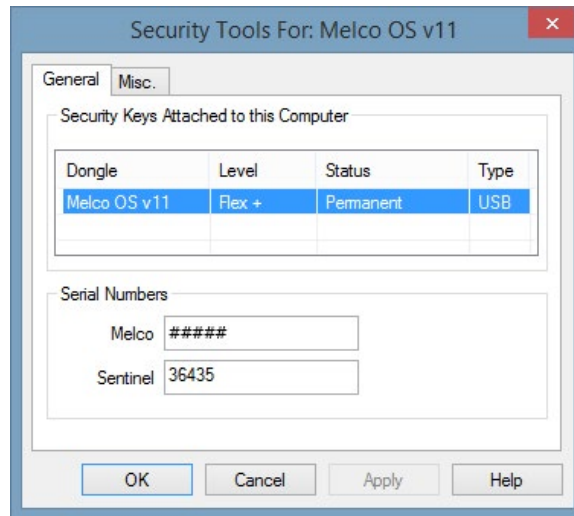
1. Click the Reset All button.

Tools Menu > Security

Selecting Tools > Security will bring up the security tools.

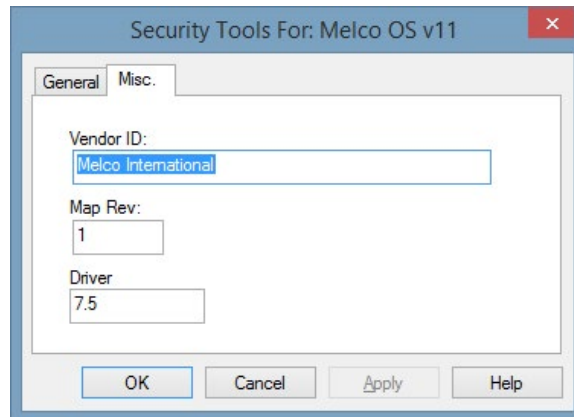
General Tab

The General Tab will contain information on the security keys attached to the computer and the serial numbers of those keys.



Misc Tab

The Miscellaneous Tab contains information on the vendor, the map rev, and the driver.

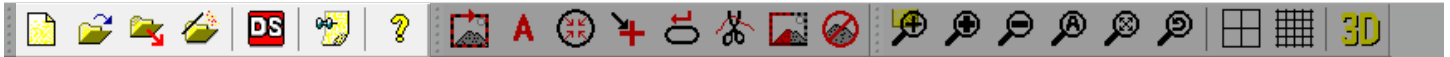


Toolbars

The toolbars in your software provide quick access to many of the software tools and features. They can be hidden or shown by navigating to View > Toolbars and ensuring that any toolbar you wish to see has a check beside it.

Standard Toolbar

The standard toolbar contains many tools dealing with the files as well as the help documentation.



Unless otherwise described, the function of these tools are as described in the File Menu section of this document.



New



Open



Load Design



Load Design Wizard



DesignShop - This tool allows you to open the currently loaded design in DesignShop



Notes

Machines Operations Toolbar

The Machine Operations Toolbar contains access to many machine functions.



Unless otherwise described, the function of these tools are as described in the Commands Menu section of this document.



Trace Design



Applique (Frame Movement)



Center Hoop



Return to Origin



Reset Design



Trim Immediate



Display Stitches Sewn



Test Sew Mode

View Toolbar

The View Toolbar contains the zoom tools as well as view settings such as the origin, grid, and 3D rendering.



The functions of these tools are described in the View Menu section of this document.



Graphical Zoom



Zoom In



Zoom Out



(Zoom) Actual Size



(Zoom) Fit Window



Zoom Previous



Design Origin



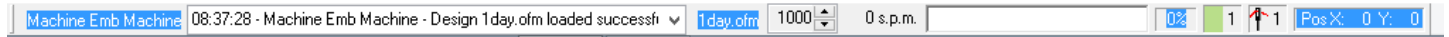
Display Grid



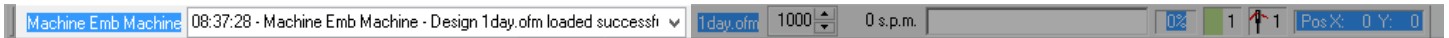
Display in 3D

Machine Bar

The machine bar appears at the bottom of the screen. It shows information about the machines that are connected to the software.

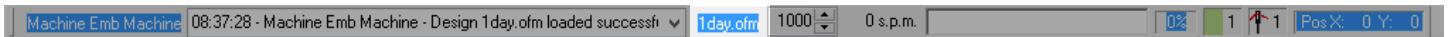


The first area of the machine bar identifies and displays information about the active machine (the machine with focus).



This area also displays any messages (such as error messages) concerning the active machine.

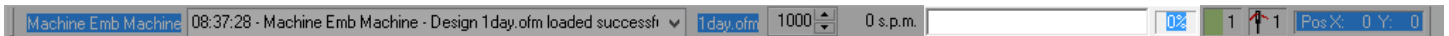
The next section displays the name of the currently loaded design file.



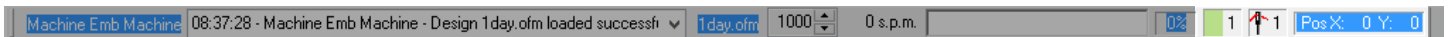
The machine speed can also be adjusted from this bar. It will show the maximum as well as the actual sew speed.



A progress bar fills in as the design is sewn. The percentage at the end shows the amount of the design that is complete.



The machine bar also shows the current color, needle, and X/Y position.



Machine List

The machine list appears by default on the left side of the screen. It displays all machines that are currently connected to the software.

The machine list displays the machines current status, for example Idle indicates the machines is currently not in use.

Machines serial numbers that are in bold are currently selected. Machines appearing in normal font are not currently selected.

To select a machine, click or tap on it in the machine list.



Machine Views

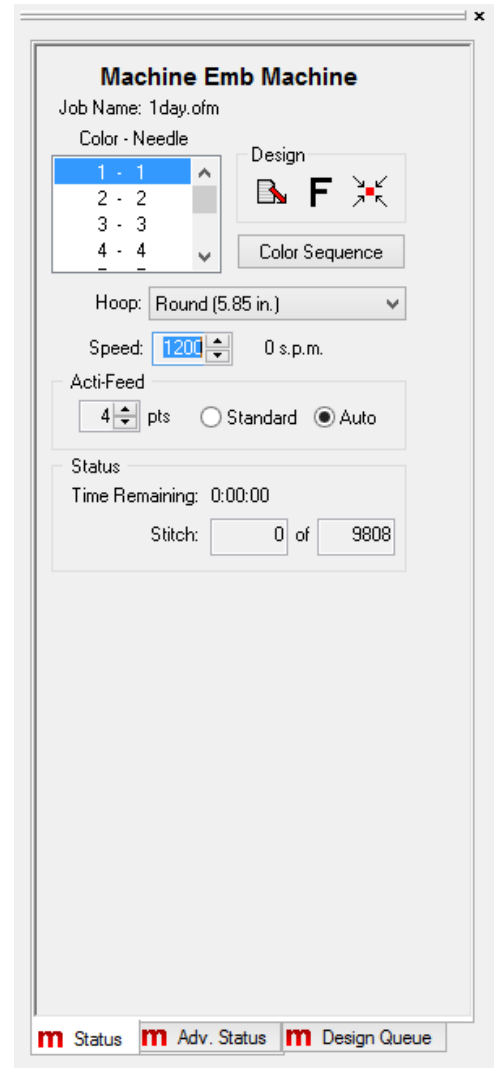
The machine views appear by default on the right side of the screen. These views are meant to give you quick access to the majority of settings needed to run a job as well as the most needed machine information. There are three tabs in the machine views.

For more information on loading a design and using the settings described, please see the “Loading a Design” section of this document.

Status Tab

The status tab contains the following information and functions.

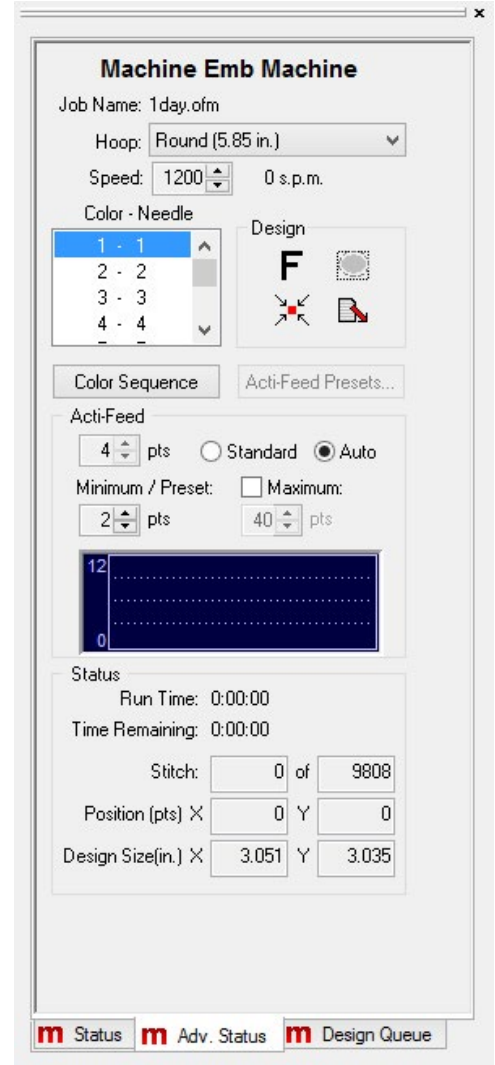
- Machine Name
- Job Name
- Color Sequence - From here, you can see the current color as well as set the color sequence for the currently loaded design.
- Load Machine Settings - If machine settings have been saved in the loaded OFM design, clicking or tapping the load machine settings button will load the saved settings to the machine.
- Design Orientation (Rotation) - Clicking or tapping on this icon will begin to rotate the currently loaded design in 90° increments.
- Hoop Selection - From this menu, a properly sized hoop should be select.
- Sew Speed - The maximum sew speed can be set here. The actual sew speed will be displayed to the side. Remember that if the machine needs to slow down for longer stitch movements, it will do so automatically.
- Acti-Feed Settings - From here, the acti-feed settings can be set. Chose between auto or standard and set the material thickness if needed.
- Status - The machine status is read back as a calculated time remaining as well as a stitch count out of the whole.



Advanced Status Tab

The advanced status tab builds on the status tab. It adds more information and a couple more settings. Additionally, you will find the following on the Advanced Status Tab.

- Acti-Feed Presets - These are guidelines for using Standard Acti-feed
- Act-Feed Minimum and Maximum - The Minimum and Maximum are used as guidelines for auto acti-feed. They can be helpful in controlling thread dynamics or sewing specialty applications.
- Run Time - The run time displays how long a job has been running on a machine.
- X/Y Position - This displays the X and Y position of the hoop on the machine in relation to the needle.
- Design Size - The design size has also been added to the advanced status tab.



Design Queue

The Design Queue Tab allows users to add designs to a pending designs list. While placing designs in the queue does not load them to the machine, it does provide faster access to them when they are ready to be loaded to the machine and sewn.

The Design Queue Tab contains three sections:

Machine

This is the serial number of the currently selected machine.

Current Design

This displays the current job and the number of runs completed out of the number of runs needed.

- Save As - Allows the user to save the design that is currently loaded in the machine.
- Edit - Allows the user to edit the design that is currently loaded in the machine.
- Notes - Displays a dialog containing the design notes and operator notes.
- Number of Runs: - Allows the user to set the number of runs needed for that design. Click on the up or down arrows to the right of the field to change the number.

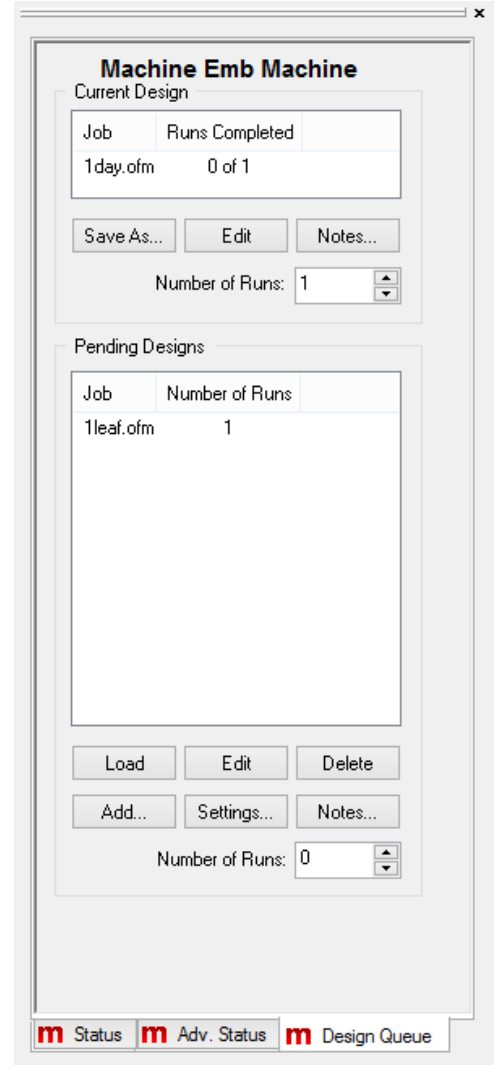
Pending Designs

Load - Loads the currently selected design into the machine. If no design is selected, it will load the first design in the list.

- Edit - Allows the user to edit the selected design.
- Delete - Deletes all the selected designs from the queue.
- Add - Adds new designs to the queue. The user can select more than one design at a time to add.
- Settings - Takes the user directly to the Settings Tab property page which contains all the options for the design queue.
- Notes - Displays a dialog containing the design notes and the operator notes.
- Number of Runs: - Allows the user to set the number of runs needed to complete the job for the selected design.

Adding Designs to the Design Queue

Designs can be added to the Design Queue in three ways.



- [Add] Button

Clicking on the [Add] in the lower half of the Design Queue tab will bring up an open dialog box. From here, select the design or designs you wish to add to the queue. Multiple designs can be selected by holding the CTRL key on your keyboard while clicking on the desired files. Click on [Open] to add the selected design(s) to the queue. If multiple machines are in the Machine List, a machine selection window will come up. From here, you can select which machine queue you would like to add the design to.

- File Menu

Menu commands can also be used to add designs to the queue. By going to File>Queue Design, an Open dialog box will come up. From here, select the design or designs you wish to add to the queue. Multiple designs can be selected by holding the CTRL key on your keyboard while clicking on the desired files. Click on [Open] to add the selected design(s) to the queue. If multiple machines are in the Machine List, a machine selection window will come up. From here, you can select which machine queue you would like to add the design to.

- Pending Folder

Designs placed in the pending folders through Windows Explorer will appear inside the Design Queue. To use the pending folders, you will need to navigate to them through Windows Explorer. If this method is going to be used often, it may benefit you to place a shortcut to these folders in a more convenient location such as your desktop. Each machine has its own pending folder in the Melco OS install directory. (An example path for these pending folders would be C:\Program Files\Melco\Melco OS v#\Jobs\“Machine Serial Number”\Pending.) Designs can be copied from any folder and pasted into this Pending folder.

Changing the Order of Pending Designs

The order of designs in the Pending Designs list can be altered by selecting a design and then clicking and dragging it to a new position in the list.

Loading Designs From the Queue to a Machine or Machines

To load a design to a machine from the queue, select the machine(s) in the machine list. If multiple machines are needed, hold the CTRL key on your keyboard while clicking on the desired machines. Each machine that is selected will show in the list with a highlighted color.

Next, click on the [Load] button located beneath the Pending Designs list. The selected (highlighted) design in the Pending Designs list will be loaded to the selected machine(s). If no design is selected, the top-most design in the list will be loaded.

Removing Designs From the Queue

Designs can be removed from the queue by either selecting the design in the Pending Designs list and clicking the [Delete] button, or they can be removed from the pending folder mentioned above.

Designs can also be set to automatically be removed from the queue when they are loaded. To access these settings, click on the [Settings] button in the lower portion of the Design Queue tab. For more information, read the Design Queue section under the Settings Tab in this Help document.

Master Queue (Flex+ ONLY)

When enabled through the Settings Tab, the Master Queue tab replaces the Design Queue tab in the Machine Views.

In most ways, the Master Queue functions like the Design Queue. Jobs are added, loaded, and removed through the software in the same way. The biggest difference is that with the Master Queue, all of the machines in the Machine List pull from the same queue. This means that they can share jobs, and that when designs are added to the queue, no machine selection window pops up.

Share Jobs

Using multiple machines to complete large orders is an effective way to complete your Pending Designs. If a job is loaded to multiple machines, the Number of Runs tracks the number of times a design has been completed on any of the machines. As designs are completed, the Number of Runs goes down. When it reaches zero, the job is complete.

Automate It

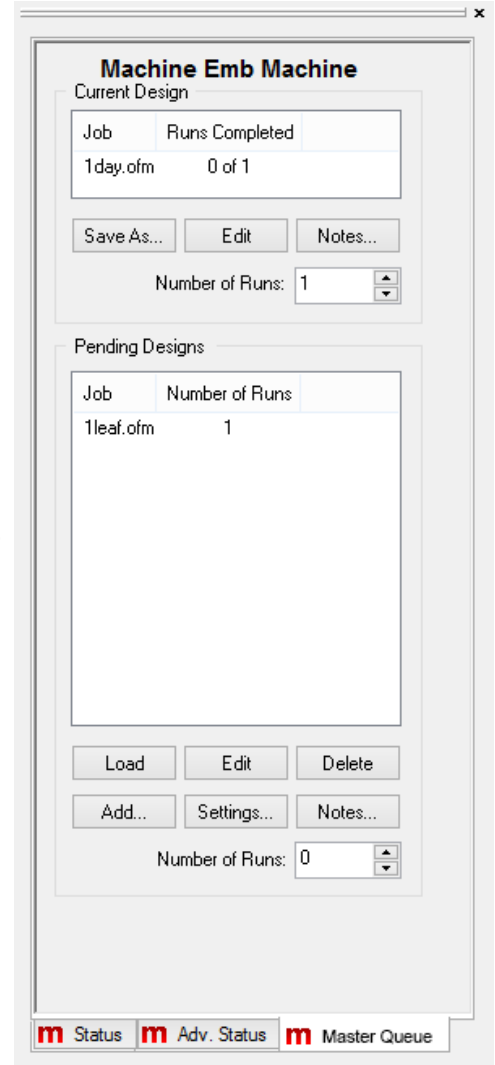
Design Queue

- Auto Load Next Pending Design
- Prompt Before Auto Load
- Show Operator Note Dialog On Design Load
- Remove Designs From Queue On Design Load
- Enable Master Queue

Combining the Master Queue with “Auto Load Next Pending Design” and “Remove Designs From Queue On Design Load” in the Settings Tab begins to automate your workflow. When all of the runs for a job have been loaded to machines, the job will be removed from the queue. The next machine to finish sewing will automatically load the next pending job in the Master Queue. It can begin sewing on the next job while the other machines in the Machine List finish up the designs that they’re running.

Using “Auto Define Color Sequence” in the Settings Tab will further speed up the process. With this setting enabled, the software can automatically define the color sequence of the newly loaded design based on the color information in the thread cone display.

With all of the automatic settings, you may want a visual cue that a job has changed and you may need to switch the product you are sewing on. By enabling “Show Operator Note Dialog On Design Load” in the settings tab, the Operator and Design Notes will pop up on screen when a new design is loaded to a machine.



Keeping a Machine Separate

Although enabling the Master Queue through the Settings Tab enables it for all machines in the Machine list, the settings to “Auto Load Next Pending Design” can be set per machine. If a machine in the list does not have this setting enabled, designs can be loaded to the machine manually through File>Load Design.

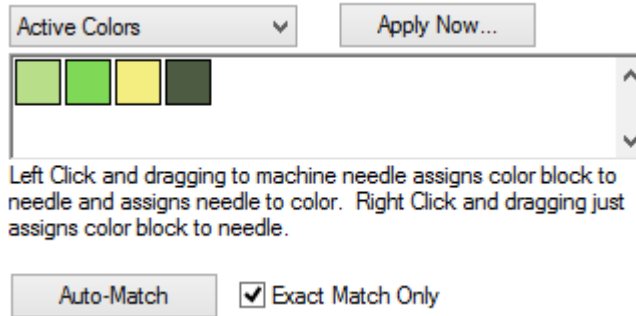
Master Queue Folder Location

Designs can be placed in the pending folder for the Master Queue through Windows Explorer just like they can for the Design Queue. The process is the same, but the location of the folder is different. An example path for the Master Queue pending folder would be C:\Program Files\Melco\Melco OS v#\Pending.) Designs can be copied from any folder and pasted into this Pending folder.

Setting the Color Sequence Using Active Colors

If a color sequence is programmed in the Color - Needle box, needles will assign to active colors based on that information. It may be best and far less confusing to click [Clear All] before beginning to assign needles.

Clicking the Clear All button once will clear any existing color sequence from the Color - Needle field. Clicking the Clear All button a second time will remove any needle assignments from the active colors.



Manually Assigning Needles

To manually assign needles to active colors, you can left-click and drag the active color block to the appropriate needle in the thread cone display. This gives the thread color properties to the needle, and it also assigns that needle to the active color block.

If you want to assign a needle to a color block but do not wish to change the color properties of that needle, you can right-click and drag the active color block onto the desired needle. This might be done if in a design with white lettering, you wanted to sew the lettering in bright green. You would right-click and drag the white active color onto the bright green needle number in the thread cone display.

When an active color has been assigned a needle, the needle number will be displayed inside the colored square. Unassigned colors display no number.

Automatically Assigning Needles

If your thread cone display is populated with thread colors, it may be faster to click the Auto-Match button. Auto-Match compares the active colors to the color properties for each of the needles in thread cone display and assigns needles to any color blocks that it finds matches for.

If it does not find a match and "Exact Match Only" is unchecked, it will assign the needle with the closest color match (based on RGB values) AND set the color sequence in the Color - Needle field.

If "Exact Match Only" is checked, it will prompt you to choose an appropriate needle.

Setting the Color Sequence with Active Colors

If needles have been assigned to every active color, clicking [Apply Now] will set the color sequence based on that information.

Additional Information on Color Sequence

Color Properties

Right-clicking on a numbered circle in the thread cone display allows you to access and change the color properties of that needle.

Color Chart

The Color Chart drop-down menu allows you to choose from any of the thread charts included with the software. This can be helpful in finding the exact thread color you are planning on using.

If you have additional thread charts installed on your computer, you may copy these files through Windows Explorer and paste them into the Color Data folder located in the program file folder. Thread Charts have the file extension of TCH.

Color

The number displayed in the box labeled "Color:" represents the needle number on the thread cone display that you are currently setting the color properties for. Using the up or down arrows will move you through needles 1 through 16 without having to exit the Color Properties window and choose a different needle.

Color Preview

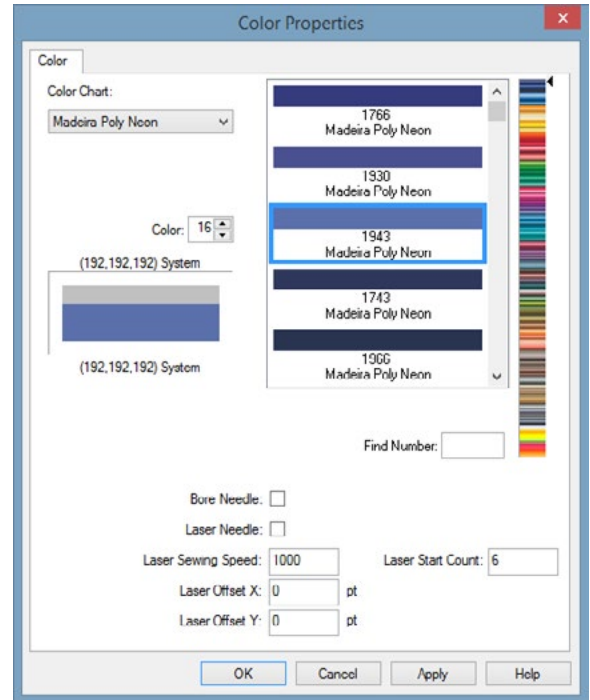
The Color Preview displays three colors. The top is the current color. The bottom is the newly selected color. The ring around both colors displays the background color. As new colors are selected, the bottom half of the preview will change to reflect the new selection. When [Apply] is clicked, the top half will display that color as well. This indicates that the color is now the current color.

In the example above, the current color is being displayed by (192, 192, 192) System color. The newly selected color is displayed as Madeira Neon Polyester color 1943 Copen.

Color Selection

On the right side of the color properties dialogue you can choose from a list of colors available in the selected color chart. Thread colors may be displayed with a thread color, name, or both.

If System RGB is the selected color chart, the standard windows color selector and mixer are displayed to the right.



Find Name / Find Number

If you know the name or number for the thread that you would like, you can enter that into the corresponding field and click [Go] to search the thread chart for it. Partial names can also work. If you the name of thread was called "Apple", you could choose the appropriate thread chart, type "Apple" into the "Find Name" field, and click [Go]. It might then bring up a red called "Candied Apple". If you were to click [Go] again, it would bring up the next color with the word "Apple" in the name, such as a light green called "Green Apple".

Bore Needle

Typically used with boring needles, when checked, this disables all thread detection and thread feed for the needle.

Laser Settings (Needle 16 ONLY)

Only available for needle sixteen, this feature disables all thread detection and acti-feed. It also allow you to specify a stitch speed and X and Y offset.

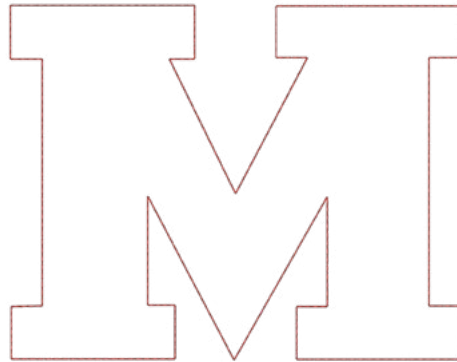
Sewing An Appliqué

Appliqué and tackle twill designs are designs that are specifically digitized for using fabric instead of stitches to fill in an area of a design.

There are entire magazine and book articles devoted to different ways of doing appliqué with different types of fabric. The variety is endless, but the core process remains mostly the same.

Anatomy Of An Appliqué Design

1. Placement Stitch - To start, the embroiderer needs to know where to place the material and in what shape to cut it. This is accomplished through a walk or run stitch that traces the outside edge of the appliqué shape. This stitch line is referred to as a placement stitch, a locater stitch, an outline stitch, or sometimes even the cut line. No matter what the line is called, it has the same purpose. It shows the embroiderer where to place the appliqué material.



2. Place the Material - Typically after the placement stitch is sewn, the machine will be stopped so that the material can be placed. Usually a light adhesive is used to keep the material in place while it is being tacked into place. Some twill manufacturers will apply a pressure sensitive (peel-and-stick) adhesive to the back of the twill.



 *If using spray adhesive, please spray outside or at least far from your machine.*

melco

3. Tack-down Stitch - After the material has been placed, the edges are tacked down with a tack-down stitch. This stitch is usually an inset walk or run stitch, a zig-zag or tackle stitch, or an e-stitch or blanket stitch. The purpose of this stitch is to attach the material to the product as quickly as possible without shifting the material and losing the registration. Attempting to tack down with a standard density satin stitch usually leads to pucking, bunching, and shifting of the material.



4. Cover Stitch (Optional) - Many designs will stop after the tack-down, but many others will finish the edge by following up with a satin stitch cover over the top of the tack-down.



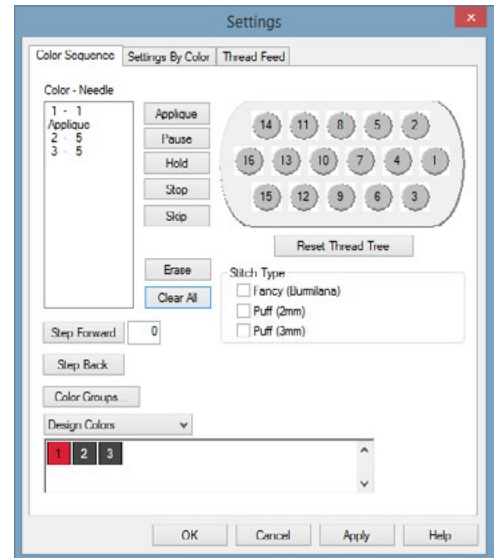
Precut Appliqué

If you would prefer to cut your appliqué material ahead of time, you can use the placement stitch as a template. Some embroiderers sew just that stitch onto the appliqué material while others sew it on a manila folder and use that as a stencil for cutting the appliqué pieces.

Setting the Color Sequence for an Appliqué Design

Appliqué elements can occur anywhere in the sequence of an embroidery design. It may help to look at the sew order in a run sheet or design software to make sure of where in the design the appliqué pieces are to be applied.

1. In the color sequence tab, begin setting your sequence like in a normal design.
2. When you reach the placement stitch, select the needle on which you wish it to sew. Many times the placement stitch thread color matches either the material that is being placed, the color of the tack-down stitch, or the material of the main product. If matching the material of the product, the stitch can be difficult to see.
3. After the placement stitch, add an appliqué command by clicking or tapping on the appliqué button. This will add an appliqué command to the color sequence. When the machine reads this command, it will stop, feed the frame as far forward as it can with the needle still within the hoop, and wait.
4. Continue setting the rest of the color sequence as normal.



Sewing the Appliqué

When you're ready to sew the appliqué design, begin sewing as you would any other design. When the machine reaches the appliqué command in the color sequence, it will stop and feed the frame out as far as it can while keeping the needle within the hoop limits.

When the machine stops, place the appliqué within the placement outline. It may be necessary to use a bit of textile adhesive to prevent the material from shifting.

When you are ready, press the start button on the keypad of the machine to command the machine to move the frame back in and sew the rest of the design.

Using a Boring Tool

Embroidery designs that utilize a boring tool will be specifically digitized for boring.

Installing a Boring Needle

To install the boring needle, simply remove the regular needle from the machine and install the boring needle as you would any other needle. Make sure that the boring needles are installed correctly so that they will be centered in the needle plate during operation.

Setting Up a Boring Needle In The Software

The software needs to know what needles contain boring needles. When a boring needle is indicated, thread detection and thread feed are disabled for that needle.

1. Access the Color Sequence tab.
2. In the thread cone display, right-click the thread cone that represents the boring needle (e.g., if the boring needle is Needle #7, right-click thread cone 7). This will open the Color Properties dialog.
3. To set the needle as a boring needle, check the Bore Needle check box.
4. Click OK to return to the Color Sequence tab.
5. Note that the boring needle is now indicated by a B in the thread cone display.
6. Repeat steps 2-4 for any other boring needles you wish to use. Typically, only a single boring needle is required.
7. Set the color sequence using the boring needles for the cutting passes in the boring design.
8. Click OK to confirm the color sequence and exit the color sequence tab.



Note: It is recommended that you clean the rotary hook after every boring operation

Laser Alignment (Design Registration)

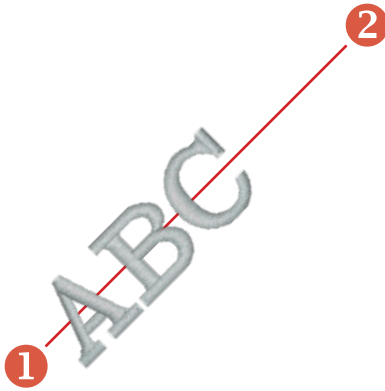
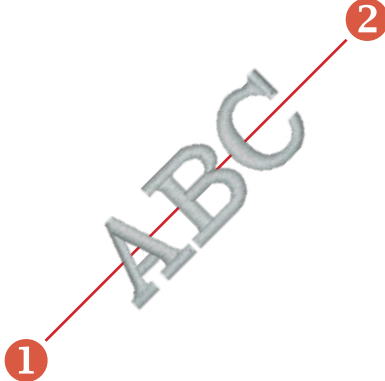
The Laser Alignment feature allows you to line up an embroidery design to a mark, such as a stripe, on a garment.

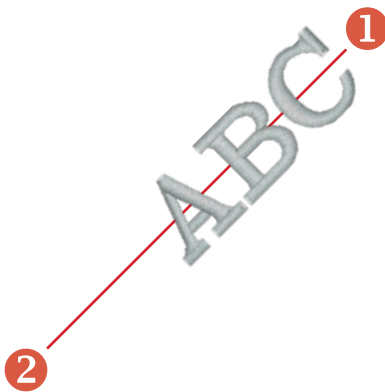






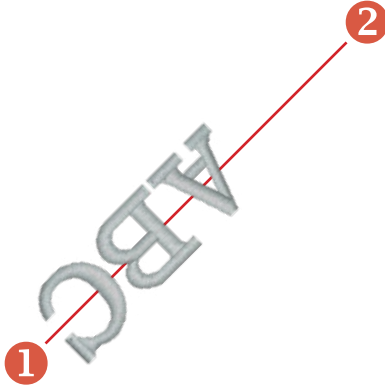






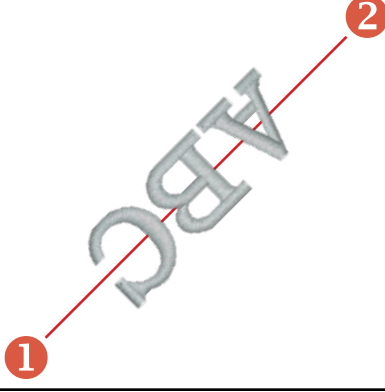






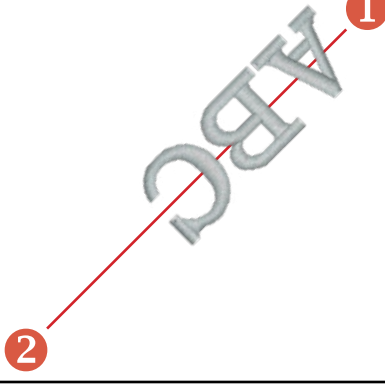






Perform the following steps to use the Laser Alignment feature:

1. Use the Hoop and Arrow key to move the laser to your first reference point (for example, the top of the stripe on the left side).
2. Press the Laser and Arrow key to confirm this point.
3. Move the laser with the Hoop and Arrow keys to your second reference point.
4. Press the Laser and Arrow key to confirm this point.
5. Press the Laser and Center key. The design aligns to the line created by your two reference points.

The placement of the design along the line depends on the Arrow keys used to input the reference points. The six variations follow:

This feature uses the design origin to determine how to rotate. This feature can also be used with a vector line stored in an OFM file to scale a design from the keypad of the machine or align based on specific points in the design. For more information on scaling and rotating a design in this fashion, read the Scaling Designs with Laser Registration section.

Desired Alignment	Keypad Commands
	<p>Design to Left of the Line:</p> <ol style="list-style-type: none"> 1. Laser + Left: + 2. Laser + Right: + 3. Laser + Center: +
	<p>Design in the Center of the Line:</p> <ol style="list-style-type: none"> 1. Laser + Left: + 2. Laser + Left: + 3. Laser + Center: +

Desired Alignment	Keypad Commands
	<p>Design to Right of the Line:</p> <ol style="list-style-type: none"> 1. Laser + Right:  +  2. Laser + Left:  +  3. Laser + Center:  + 
	<p>Design to Left, Flipped:</p> <ol style="list-style-type: none"> 1. Laser + Right:  +  2. Laser + Left:  +  3. Laser + Center:  + 
	<p>Design in Center, Flipped:</p> <ol style="list-style-type: none"> 1. Laser + Right:  +  2. Laser + Right:  +  3. Laser + Center:  + 
	<p>Design to Right, Flipped:</p> <ol style="list-style-type: none"> 1. Laser + Left:  +  2. Laser + Right:  +  3. Laser + Center:  + 

Scaling Designs with Laser Registration

Designs with a vector line with specific properties added in DesignShop can be scaled and rotated using the procedure for Laser Design Registration. This can be a useful tool when creating multimedia designs in which specific reference points would be required. It can also be used when adjust designs to fit within panels on a garment such as a sports uniform.

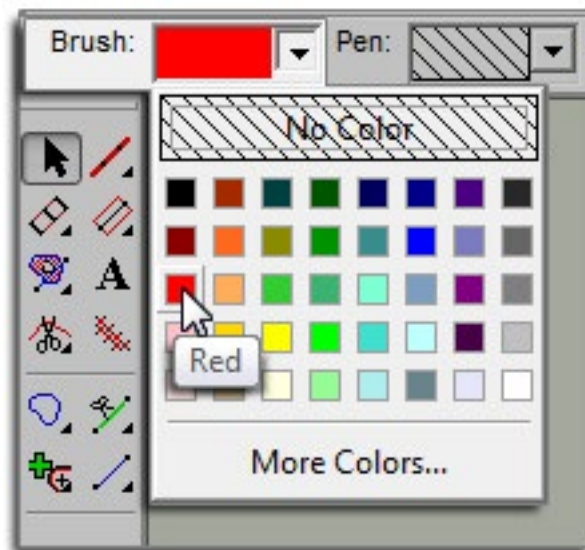
Setting Up the Design in DesignShop

Vector Line Properties

For a design to be scalable in Melco OS, it must contain a vector line element with the brush color of "Red" and a pen color can be any color.



If you're not sure which color swatch is "Red", hover over the swatches in the drop-down palette to see the name of the colors. The vector line must use these exact properties to work for the scaling feature.



Vector Line Placement

Find two points in your design that you want to use as reference points. These points can be inside or outside of the stitching area, but they need to be within the hoop limits of the hoop you are planning on using to embroidery the design. They line between them can also be at any angle. You may want to consider the application for which you are planning on using the design. If you are going to be lining up to a horizontal line in a garment, you may want to place your reference points on a horizontal line. If you are lining up embroidery to a screenprint or digital print on a garment, you may want to have the image in the behind your embroidery in DesignShop. This way, you can find distinctive features in the print to line up with.

In the example below, print will be combined with embroidery to create a multimedia design.

Using points that are farther apart will help with accuracy when scaling or rotating on the machine. Points that are closer together are more affected by slight differences in how the operator references these points on the machine.

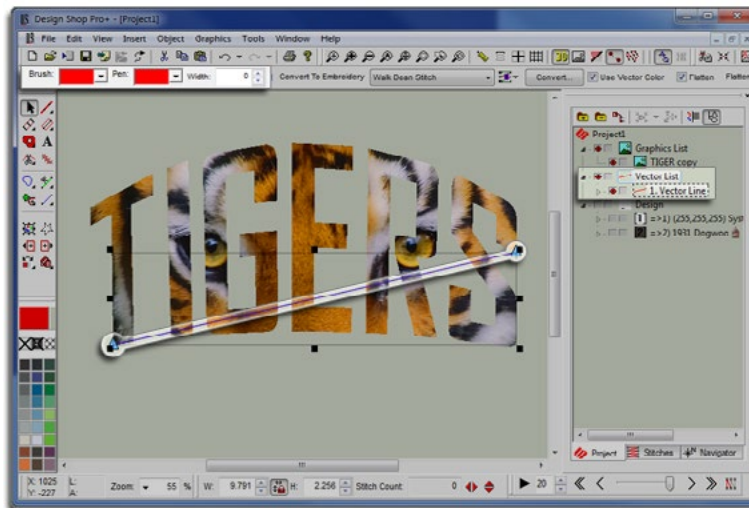
Using a the vector line tool, create a vector line between your two chosen reference points.

Once an embroidery file has the vector line with Red for the brush color, the file can be loaded to the machine.



Example

In the example below, the embroidery elements of the design were hidden to make it easier to find reference points on the print. The vector line was input with the point on the left first, then the point on the right. Notice that the points fall on sharp corners in the print. This will make them easier to line up to with the final print on the embroidery machine.



Using Laser Registration to scale and rotate the design in Melco OS

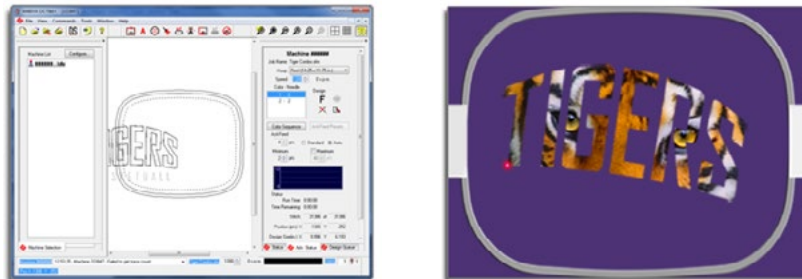
Now that the design is set up with the vector line and loaded to your machine, you can use the laser registration feature to rotate and scale the design.

In the example below, to better fit a larger garment the print was slightly enlarged from the original design file. The garment was also not hooped as straight and level as it could have been. Laser Registration can be used to compensate for both issues.



Using the hoop and the arrow keys on the machine keypad, move the hoop on the machine so that the laser light is on the first reference point on the garment. In the example, the vector line was digitized with the left input point first. This is the first reference point.

Once the laser is lined up to the first reference point, press the laser and left keys on the machine keypad at the same time. The machine will give an audible signal of two short beeps indicating that the first point has been entered.



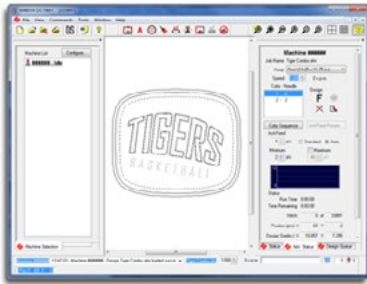
Now that the first point has been entered, use the hoop and the arrow keys on the machine keypad to move the hoop on the machine so that the laser light is on the second reference point on the garment. In the example, the vector line was digitized with the left input point first. This is the first reference point.

melco

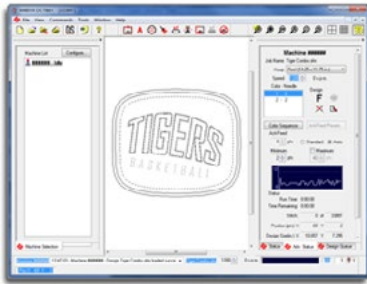
Once the laser is lined up to the second reference point, press the laser and left keys on the machine keypad at the same time. The machine will give an audible signal of two short beeps indicating that the second point has been entered.



Lastly, press the laser and center (bullseye) keys simultaneously on the machine keypad. The machine will give the same two short beeps again, and Melco OS will process the information. It will reload, scale, rotate, and reposition the design in the hoop to match the reference points entered.



The design can now be traced and sewn.

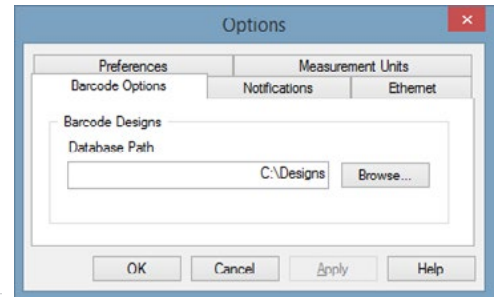


Using Barcodes with Melco OS

Using barcodes and barcode readers to load designs to machines in Melco OS is one way to speed up productions. To utilize barcodes follow the steps below.

Enable Barcodes in the Software

1. Go to Tools>Options>Barcode Options
2. Specify the database path. Enter the address of the folder containing the designs to be loaded using the barcode.
 - a. If this option is greyed out, check the "Enable" box at the top of the tab



Creating the Barcode

1. Using a barcode font, create a barcode that contain the prefix an affix for the following functions.

Function	Prefix	Name of File	Suffix
Load Design	*MB\$L\$	nameoffile.ofm	*
Load Design & Settings	*MB\$LA\$	nameoffile.ofm	*
Queue Design	*MB\$Q\$	nameoffile.ofm	*
Queue Design & Settings	*MB\$QA\$	nameoffile.ofm	*

- a. For example, to load 1day.ofm, the barcode would look like *MB\$L\$1DAY.OFM*
- b. Using a barcode font, it would look like



- c. The name of the file cannot contain spaces or underscores

The Barcode Reader

1. The barcode reader must be a keyboard wedge barcode reader.
2. The barcode reader must be programmed to read the first asterisk as a load command.
3. The barcode reader must be programmed to read the last asterisk as a return.
4. Melco OS must have focus on the computer.



Instructions for programing the barcode reader typically are brand specific and come with the reader.

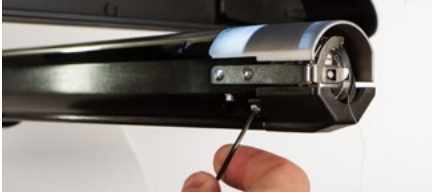
Large Table Top Attachment (Option)

If purchased, the large table top attachment may be installed to provide additional support at the needle plate level. This could be used with large heavy blankets, quilts, or other flat goods.

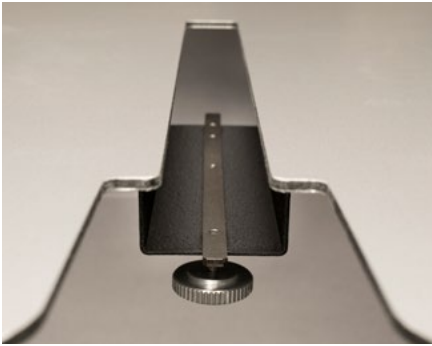
Installing the Large Table Top Attachment

To install the large table top attachment, use the following steps.

1. Remove the hook guard by loosening the screws on either side of the lower arm with a 2mm hex wrench, and sliding the hook guard forward. The screws do not need to be completely removed.



2. Loosen the knobs of the t-nut in the lower support bracket until the top of screws are flush with the t-nut.



3. Slide the table into place while inserting the t-nut into the t-channel on the bottom of the lower arm of the machine.
4. Rotate the support legs down from the table top to rest on the lower legs of the machine.



5. Tighten the knobs in the t-nut to fully secure the table.



Removing the Large Table Top Attachment

To remove the large table top attachment, use the following steps.

1. Loosen the knobs in the t-nut to release the table top. Loosen them enough to remove the table top, but not so much as to remove the screws from the t-nut.



2. Rotate the support legs up to the table top. This will collapse them and make the table top easier to remove and store.
3. Slide the table forward and remove the t-nut into the t-channel on the bottom of the lower arm of the machine.
4. Replace the hook guard and tightening the screws on either side of the lower arm with a 2mm hex wrench. Do not over tighten the screws..

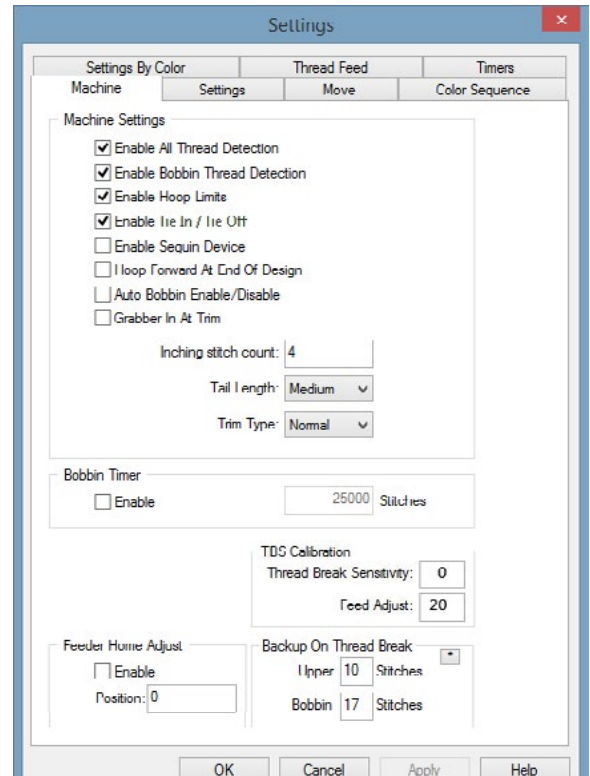


Thread Feeder Home Adjustment Procedure

A very small percentage of machines exhibit thread feeder “clicking” during color change. This clicking occurs when the home position of the feeder drive gear is not aligned correctly with the feed gears in the thread feeder assembly. The user can adjust the home position of the feeder drive gear to alleviate this in machines that exhibit the problem.

To adjust the feeder home position, do the following:

1. Go to Tools>Settings>Machine Tab. Check Enable under Feeder Home Adjust. Click Apply and OK.
2. Select the Head Timing tab in the Maintenance dialog.
3. Move the needle case to needle 1 by pressing the left arrow and needle case keys on the machine keypad.
4. Sight down the thread feeder gears from the right side of the color change mechanism. From here, you can see how the feeder gears mesh.
5. Adjust the alignment by pressing the center key and right arrow key (positive direction) or the center key and left arrow key (negative direction) on the machine keypad. The machine will beep to confirm. After each command, the feeder mechanism will re-home using the new value.
6. Once the alignment looks good, verify it by manually color changing from needles 1-16 several times. If clicking is still observed, go back to step 5.



i Notes:

The range of adjustment is ± 7 .

These settings (enable and the adjustment value) are stored permanently in the machine control board. If you change control boards, you will have to readjust the feeder home or you can write down the adjustment value from the old board and enter it into the new board using Melco OS.

This feature is available in RSA versions 4.02 and later. If you switch to an older version of RSA file, the machine will revert back to the old way of homing the thread feeder, but the settings will NOT be erased.

i

Machine Maintenance

This section describes the procedures involved in maintaining your machine. This section is very important, because maintenance is essential to the performance of your machine.

Cleaning

It is very important that you clean your machine regularly. Dust and lint accumulation can damage both electrical and mechanical systems.

Exterior Surfaces

Clean outer surfaces once per month with a soft, clean cloth, a mild detergent and water. Wring out the cloth before wiping the surfaces. Do not get water or any other fluids inside the machine or on any of the working mechanical surfaces.

If an accidental spill occurs, turn the machine off then wipe up excess fluid with a clean dry cloth and allow the machine to dry completely before turning the power on.

Interior Surfaces (PCB)

The main PCB can be damaged by dust accumulation. It is important that you periodically remove this accumulation. To do so, complete the following steps:



CAUTION!! Before proceeding, turn the machine off, but leave it plugged in.

1. Remove the base cover. You will see the EMI shield covering the main PCB.
2. Remove the screw(s) that hold the EMI shield in place.
3. Carefully lift the EMI shield from the main PCB. If required, disconnect the fan connector from the main PCB.



CAUTION!! Be careful not to drop metallic hardware or tools onto the Main PCB while it is exposed. Doing so can result in severe damage to the electronics that might be expensive to repair.

4. Use any compressed air labeled as ESD safe (and labeled for use on electronic components) to blow any accumulated dust out of the base interior. When doing so, do not touch the main PCB.

Some compressed air brands have a liquid accelerant that is discharged from the container while blowing dust off the machine. Always allow any liquid discharge to completely evaporate before turning the machine back on.

5. Carefully place the EMI shield over the main PCB and re-install the screws.
6. Replace the base cover before turning the machine back on.

Rotary Hook and Trimmer Assembly area

Lint and dust can build up in the trimmer assembly and the rotary hook. Clean this at least once per day.

1. Turn off the machine.
2. Remove the needle plate by removing the two screws on the underside of the extrusion.
3. Clean the exposed area with canned or compressed air.



Note: Excessive thread or lint buildup may require removal or disassembly of the trimmer.

You should also frequently check this area for loose thread.

If you are frequently performing applications that require you to use adhesive spray, it is recommended that you clean the rotary hook area at least once a day with a lightweight lubricant spray (such as WD-40). To do this:

1. Turn off the machine.
2. Remove the needle plate by removing the two screws on the underside of the extrusion.
3. Clean the exposed area with canned or compressed air.
4. Spray the exposed area with a lubricant spray.
5. Turn the machine back on, then rotate the hook all the way around a couple of times.
6. Spray the exposed area with canned or compressed air again.
7. Re-install and center the needle plate.

Lubrication & Maintenance Schedule

Any tools or supplies needed for these procedures are provided in your operator’s kit.

Using the correct lubricants properly and when specified by scheduled maintenance is critical to the operation of the machine. Failure to use the proper lubricants as specified can shorten the usable life span of internal components and can void the warranty. Using the wrong lubricants can adversely affect your machine. The recommended and authorized lubricants to be used on the machine are specified below:

Part Number:	Part Name	Comments
34275	Oiler, 3/4 oz. bottle	sewing machine oil
32078	Grease, EMB-Polymer, 8 oz bottle	polymer light grease
34463	Grease, HP, 8 oz bottle	HP grease

Maintenance Schedule

The following table summarizes the lubrication points and schedule for your machine. The table also lists which type of lubrication you should use for each lubrication point.

Please note that these schedules are meant to be used as guidelines. Depending on many circumstances (such as environment, garment types sewn on, etc.), you may need to lubricate your machines more or less frequently. Follow a lubrication schedule that best fits your needs to take care of your machine(s).



WARNING!! *Do not attempt to lubricate the machine while it is in operation.*



Important: The color change lead screw is greased for life and should NEVER be lubricated by the user or a technician.

To perform maintenance the maintenance on the machine, go to Tools>Settings>Timers tab. The timers tab contains the stitch timers for the maintenance procedures. Clicking or tapping the Step button by any of the timers will begin to walk you through the maintenance procedures. The software will move the machine through all the appropriate positions for the maintenances as well as give instructions and graphic prompts.

The maintenance procedures will need to occur on the intervals below.

- 200,000 stitches
- 2,000,000 stitches
- 10,000,000 stitches
- 30,000,000 stitches
- Thread Feed Rollers 30,000,000 stitches

As you step through the maintenance, you will see the steps below.

200,000 Stitch Maintenance




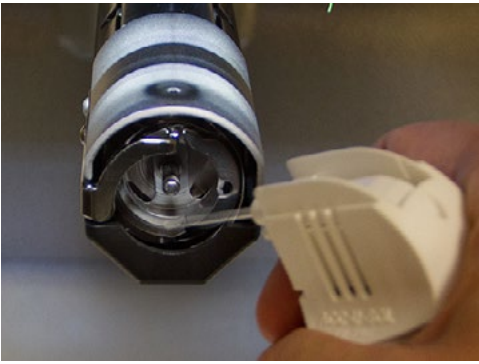
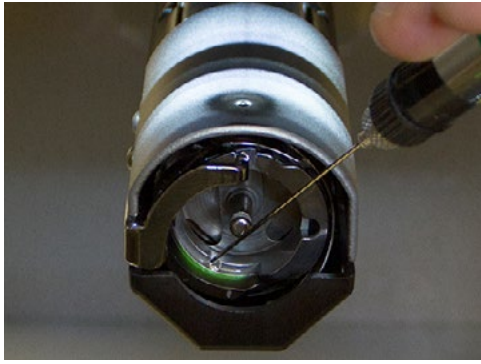


Image	Instructions
	<p>“Please follow all of the maintenance procedures carefully and apply the proper amounts of the specified lubrication during each step. Melco cannot be held responsible for any machine damage due to lack of or wrong type of lubrication. Melco cannot be held responsible for any machine damage due to not following the listed maintenance steps. You will now be guided through the hook maintenance. Press the next button to continue.”</p>
	<p>“Oil Frequency The rotary hook should be oiled approximately every 200,000 stitches or 4-5 hours of solid running. This will keep the machine running smoother, quieter, and prevent thread breaks. WARNING! Never attempt to remove or insert the bobbin with the machine is in operation. If you have a product on the machine, please remove it to avoid oil spots. Press the next button to continue.”</p>
	<p>“Remove Bobbin Case Remove the bobbin case. It can be removed from the lower arm of the machine by locating the release lever on the bobbin case. Pull forward on this lever until the case is free from the machine. This would also be a good time to clean and test the tension the bobbin case. Press the next button to continue.”</p>
	<p>“Rotary Hook and Trimmer Clean the rotary hook and trimmer area with a brush or canned air. Keeping this area clear of lint and debris will help ensure proper trimming and reduce thread breaks. Press the next button to continue.”</p>

Image	Instructions
	<p>“Apply Oil Using a small oiler bottle, apply one (1) drop of sewing machine oil to the hook oiling area. This area is highlighted in green in the image. Press the next button to continue.”</p>
	<p>“Insert Bobbin Case Insert the bobbin and case into the machine with the pigtail facing up. Push on the bobbin case until it snaps into place. Trim the thread to 2-3 inches. Press the next button to continue.”</p>
	<p>“Finished! This completes the hook maintenance procedure. Press the finish button to exit the maintenance procedure, reset the timer, and continue working.”</p>

2,000,000 Stitch Maintenance



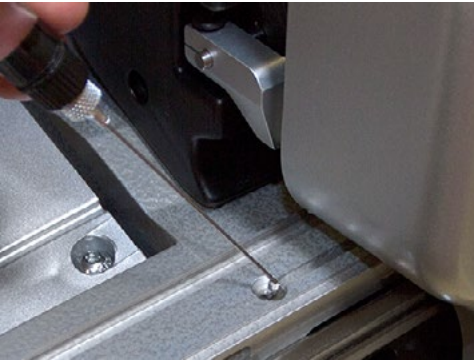

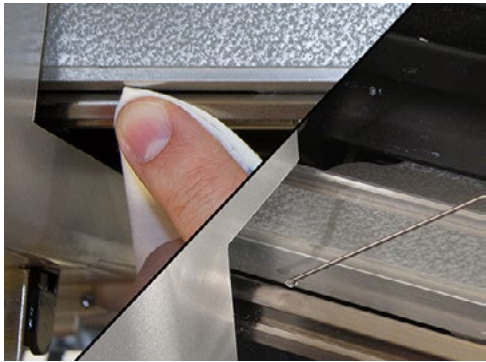

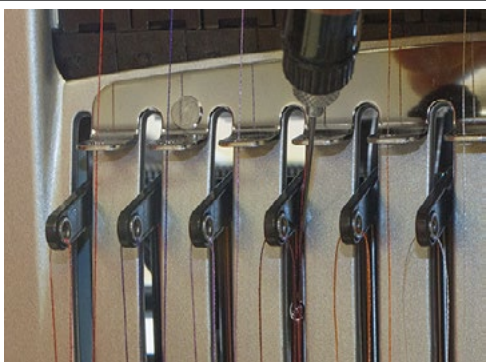

Image	Instructions
	<p>"Please follow all of the maintenance procedures carefully and apply the proper amounts of the specified lubrication during each step.</p> <p>Melco cannot be held responsible for any machine damage due to lack of or wrong type of lubrication. Melco cannot be held responsible for any machine damage due to not following the listed maintenance steps.</p> <p>You will now be guided through the 2,000,000 stitch maintenance procedure covering the following: Needle Drive and Upper V-Rail Needle Bars</p> <p>Press the next button to continue."</p>
	<p>"WARNING!</p> <p>If you currently have a hoop or clamping system on the machine, please remove it.</p> <p>Failure to fully remove a clamping system can result in damage to the machine.</p> <p>When you press on the next button, the machine will move to the appropriate position.</p> <p>Press the next button to continue."</p>
	<p>"Needle Drive</p> <p>Using a small oiler bottle, put twenty-five drops (25) of sewing machine oil in the oiling change as shown in the image.</p> <p>Note: You may have to add a few drops and wait before adding more to prevent the channel from overflowing.</p> <p>After adding the oil, wait ten minutes before pressing the next button.</p> <p>Press the next button to continue."</p>
	<p>"Left Upper V-Rail</p> <p>Using a piece of lint-free cloth, wipe clean both the front and back surfaces of the upper v-rail on the LEFT side of the needlecase.</p> <p>After cleaning the v-rail, use a small oiler bottle to apply a drop of oil each to the front and the back surfaces of the v-rail. Apply the oil close to the needlecase.</p> <p>When you press the next button, the machine will move to the appropriate position for the next step.</p> <p>Press the next button to continue."</p>

Image	Instructions
	<p>" Right Upper V-Rail Using a piece of lint-free cloth, wipe clean both the front and back surfaces of the upper v-rail on the RIGHT side of the needlecase. After cleaning the v-rail, use a small oiler bottle to apply a drop of oil each to the front and the back surfaces of the v-rail. Apply the oil close to the needlecase. When you press the next button, the machine will move to the next maintenance position. Press the next button to continue. "</p>
<p>Remove needlecase access cover on legacy machines.</p>	
	<p>" Oil Needle Bars (Lower) Using a small oiler bottle, apply one (1) drop of sewing machine oil to each of the sixteen (16) needle bars through the hole in the needlecase as shown in the image. Press the next button to continue. "</p>
	<p>" Oil Needle Bars (Upper) Using a small oiler bottle, apply one (1) drop of sewing machine oil to each of the sixteen (16) needle bars by guiding the oiler applicator through the vertical slots of the needlecase cover just below the take up lever arms as shown in the image. When you press next, the machine will move to the home position. Press the next button to continue. "</p>
<p>Trimmer maintenance steps on legacy machines.</p>	
	<p>" Finished! This completes the 2,000,000 stitch maintenance procedure. Press the finish button to exit the maintenance procedure. "</p>

10,000,000 Stitch Maintenance




Image	Instructions
	<p>"Please follow all of the maintenance procedures carefully and apply the proper amounts of the specified lubrication during each step.</p> <p>Melco cannot be held responsible for any machine damage due to lack of or wrong type of lubrication. Melco cannot be held responsible for any machine damage due to not following the listed maintenance steps.</p> <p>You will now be guided through the 10,000,000 stitch maintenance procedure covering the following:</p> <ul style="list-style-type: none">X-Drive RailsY-Bearing BlocksX-Cable Tension (Test)Grabber Eccentric <p>Press the next button to continue."</p>
	<p>"WARNING!</p> <p>If you currently have a hoop or clamping system on the machine, please remove it.</p> <p>Failure to fully remove a clamping system can result in damage to the machine.</p> <p>When you press on the next button, the machine will move to the appropriate position.</p> <p>Press the next button to continue."</p>
	<p>"Remove End Cap Cover (Right)</p> <p>Remove the end cap cover on the right side of the x-beam as shown in the image.</p> <p>Press the next button to continue."</p>





Image	Instructions
	<p>"Clean Rails (Right) Wipe any lint, dust, and old grease from the front and back steel rails inside the x-beam as shown in the image. Press the next button to continue."</p>
	<p>"Grease Rails (Right) Using a clean piece of cloth, apply a thin film of HP grease to the front and back steel rails inside the x-beam as shown in the image. Replace the end cap cover that was previously removed. When you press the next button, the machine will advance to the next maintenance position. Press the next button to continue."</p>
	<p>"Remove End Cap Cover (Left) Remove the end cap cover on the left side of the x-beam as shown in the image. Press the next button to continue."</p>
	<p>"Clean Rails (Left) Wipe any lint, dust, and old grease from the front and back steel rails inside the x-beam as shown in the image. Press the next button to continue."</p>



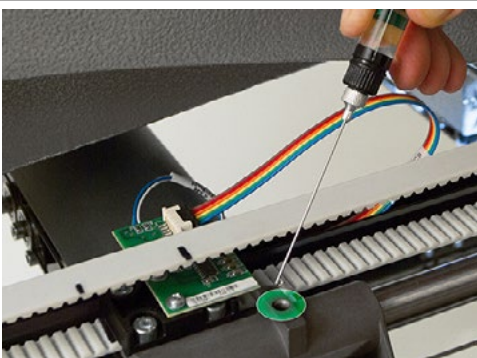
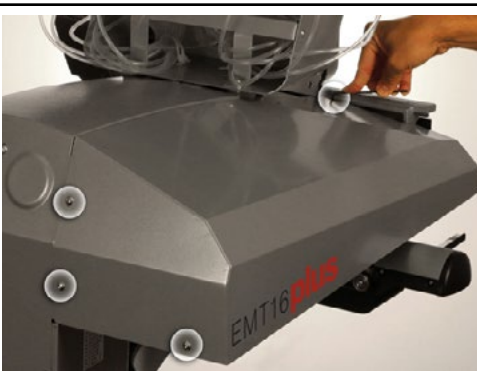
Image	Instructions
	<p>"Grease Rails (Left) Using a clean piece of cloth, apply a thin film of HP grease to the front and back steel rails inside the x-beam as shown in the image. Replace the end cap cover that was previously removed. When you press the next button, the machine will advance to the next maintenance position. Press the next button to continue."</p>
	<p>"Remove Cover (Left) Using a 3mm Allen wrench, loosen and remove the four (4) screws securing the left side cover as shown in the image. Note: The screw in the lower outer rear corner of the cover is slightly longer than the other three (3) screws. Ensure that you use the same size screws for each hole later in this procedure. Remove the left side cover from the machine. Press the next button to continue."</p>
	<p>"Oil the Bearing Block (Left) Using a small oiler bottle, place twenty five (25) drops of sewing machine oil into the oiling port as shown in the image. Note: You may need to add a few drops and wait before adding more to prevent the oiling port from overflowing. Press the next button to continue."</p>
	<p>"Replace Cover (Left) Position the left side cover in its original location on the machine as shown in the image. Loosely install the front (shorter) mounting screw to hold the cover in place. Install the other two (2) shorter mounting screws in the rear two holes near the center of the machine. The longer of the screw secures the lower outside rear corner of the cover. Carefully tighten all four (4) screws enough to secure the cover in place. When you press the next button, the machine will move to the next maintenance position. Press the next button to continue."</p>

Image	Instructions
	<p>"Remove Cover (Right) Using a 3mm Allen wrench, loosen and remove the four (4) screws securing the left side cover as shown in the image. Note: The screw in the lower outer rear corner of the cover is slightly longer than the other three (3) screws. Ensure that you use the same size screws for each hole later in this procedure. Remove the left side cover from the machine. Press the next button to continue."</p>
	<p>"Oil the Bearing Block (Right) Using a small oiler bottle, place twenty five (25) drops of sewing machine oil into the oiling port as shown in the image. Note: You may need to add a few drops and wait before adding more to prevent the oiling port from overflowing. Press the next button to continue."</p>
	<p>"Position Gauge Position the x-cable tension gauge (P/N 33909) on the x-cable as shown in the image. Press the next button to continue."</p>
	<p>"Test Tension If the x-cable is positioned within the large cut-out on the right side of the x-cable tension gauge as shown in the image, the tension is within specification. If this is the case, press on the in specification button to continue. If the x-cable is not positioned within the large cut-out on the right side of the x-cable tension gauge as shown in the image, the tension is out of specification and needs adjustment. If this is the case, press on the out of specification button to continue."</p>

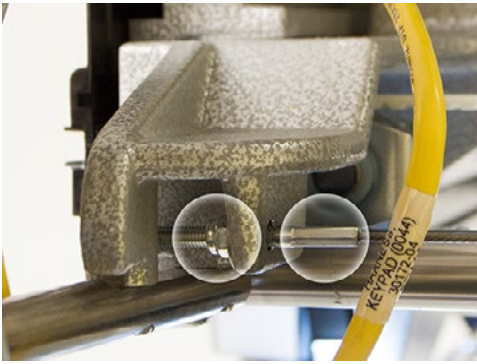
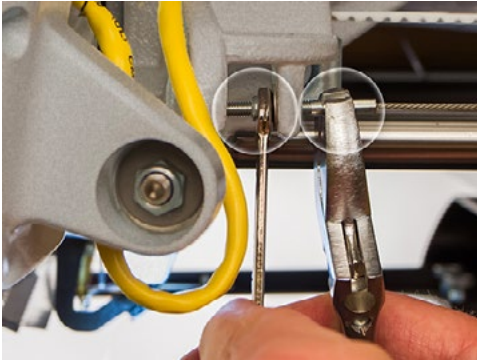


Image	Instructions
	<p>"Locate Adjustment Nut Locate the M4 nut and the x-cable tension stud and the end of the x-cable where it mounts to the front of the upper arm as shown in the image. Press the next button to continue."</p>
	<p>"Adjust Tension Using a 7mm wrench, grip the M4 nut and with a pair of pliers or adjustable wrench, grip the x-cable stud at the end of the x-cable as shown in the image. To increase tension, rotate the M4 nut with the wrench counter clockwise while holding the x-cable stud with the pliers or adjustable wrench. When the x-cable is roughly at the lower edge of the cut-out on the right side of the tension gauge, remove the wrench, pliers and the tension gauge. Press the next button to continue."</p>
	<p>"Remove Gauge Remove the x-cable tension gauge before proceeding. Press the next button to continue."</p>
	<p>"WARNING! If you proceed without removing the x-cable tension gauge, damage to your machine will occur and a service call will be necessary. Note: Melco will not be responsible for any damage to the machine or related service costs caused by not removing the tension gauge. When you press the next button, the machine will move to redistribute the tension along the x-cable. Press the next button to confirm that you have removed the gauge and continue."</p>

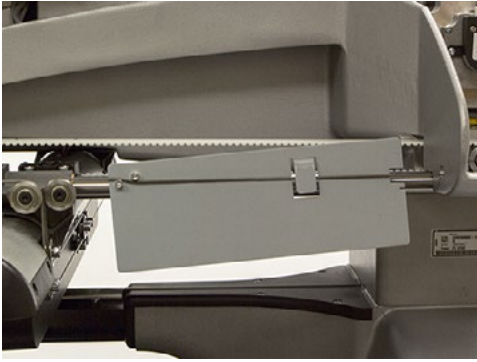



Image	Instructions
	<p>"Reposition Gauge Reposition the x-cable tension gauge on the x-cable as shown in the image. Press the next button to continue."</p>
	<p>"Test Tension If the x-cable is positioned near the lower edge of the large cut-out on the right side of the x-cable tension gauge as shown in the image, the tension is within specification. If this is the case, press on the in specification button to continue. If the x-cable is not positioned near the lower edge of the cut-out on the right side of the x-cable tension gauge as shown in the image, the tension is out of specification and needs adjustment. If this is the case, press on the out of specification button to continue."</p>
	<p>"Remove Gauge Remove the x-cable tension gauge before proceeding. Press the next button to continue."</p>
	<p>"WARNING! If you proceed without removing the x-cable tension gauge, damage to your machine will occur and a service call will be necessary. Note: Melco will not be responsible for any damage to the machine or related service costs caused by not removing the tension gauge. When you press the next button, the machine will move to redistribute the tension along the x-cable. Press the next button to confirm that you have removed the gauge and continue."</p>


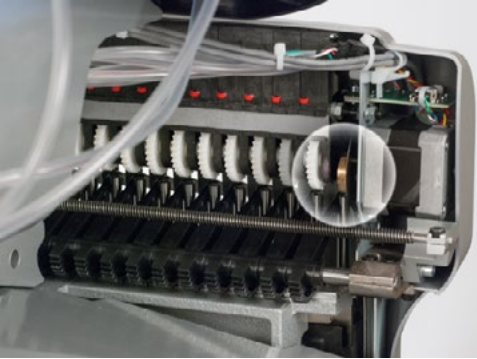
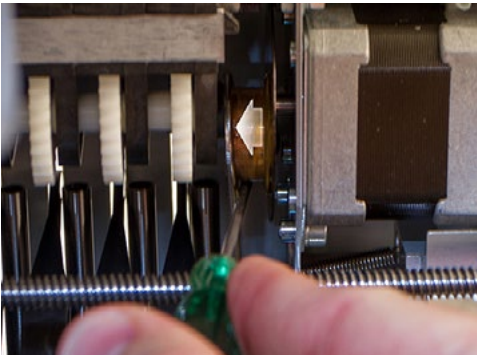
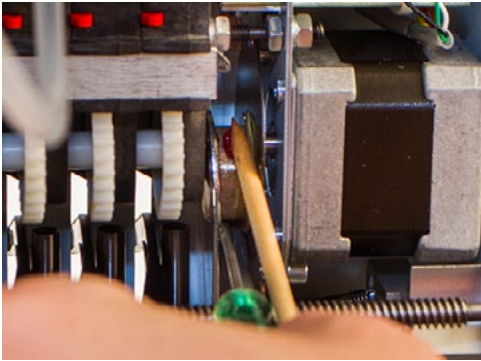

Image	Instructions
	<p>"Replace Cover (Right) Position the left side cover in its original location on the machine as shown in the image. Loosely install the front (shorter) mounting screw to hold the cover in place. Install the other two (2) shorter mounting screws in the rear two holes near the center of the machine. The longer of the screw secures the lower outside rear corner of the cover. Carefully tighten all four (4) screws enough to secure the cover in place. When you press the next button, the machine will move to the next maintenance position. Press the next button to continue."</p>
	<p>"Locate Grabber Eccentric Locate the grabber eccentric on the upper left back side of the needlecase as shown in the image. Press the next button to continue."</p>
	<p>"Move Lever With a small flat blade screwdriver, carefully move and hold the grabber connecting lever over to the left as shown in the image. Press the next button to continue."</p>

Image	Instructions
	<p>" Grease Eccentric Surface Using the grease applicator, apply a small amount of HP grease onto the grabber eccentric surface between the grabber connecting lever and the grabber home flag as shown in the image. IMPORTANT: Ensure that no grease is applied to the black grabber flag on the right side. Once the grease has been applied, release the grabber connecting lever and remove the small screwdriver. When you press the next button, the machine will return to its original position. Press the next button to continue. "</p>
	<p>" Finished! This completes the 10,000,000 maintenance procedure. Press the finish button to exit the maintenance procedure. "</p>

30,000,000 Stitch Maintenance




Image	Instructions
	<p>" Please follow all of the maintenance procedures carefully and apply the proper amounts of the specified lubrication during each step.</p> <p>Melco cannot be held responsible for any machine damage due to lack of or wrong type of lubrication. Melco cannot be held responsible for any machine damage due to not following the listed maintenance steps.</p> <p>You will now be guided through the 30,000,000 stitch maintenance procedure covering the following:</p> <ul style="list-style-type: none"> Take-Up Lever Cam, Presser Foot Cam Follower, & Right Needle Bar Guide Presser Foot Cam & Left Needle Bar Guide <p>Press the next button to continue. "</p>
	<p>"WARNING!</p> <p>If you currently have a hoop or clamping system on the machine, please remove it.</p> <p>Failure to fully remove a clamping system can result in damage to the machine.</p> <p>When you press on the next button, the machine will move to the appropriate position.</p> <p>Press the next button to continue. "</p>
	<p>" Loosen Right Upper Arm Front Cover</p> <p>Using a 3mm and a 2.5mm Allen wrench, loosen and remove the five (5) screws shown in the image.</p> <p>Press the next button to continue. "</p>

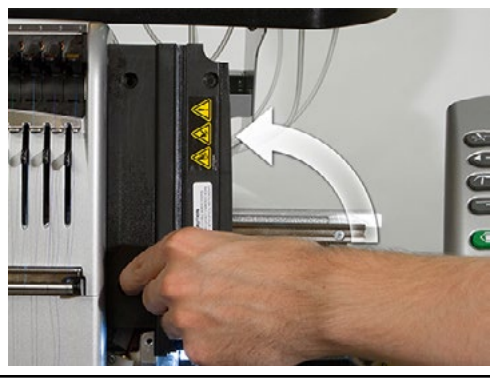
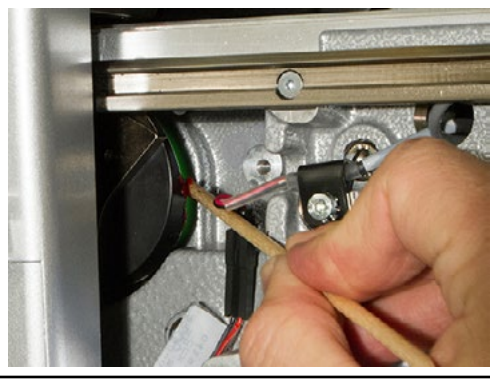

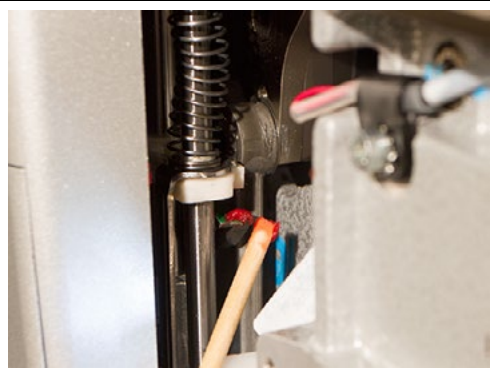
Image	Instructions
	<p>"Remove Right Upper Arm Front Cover After removing the mounting screws, move the right upper arm front cover slightly away from the machine. Then, rotate it counter clockwise as shown in the image and remove it completely from the machine. When you click the next button the machine will move to the appropriate position for the maintenance. Press the next button to continue."</p>
	<p>"Grease Take-Up Lever Cam Using the grease applicator, apply some HP grease to the back surface of the take-up Lever Cam as shown in the image. Press the next button to continue."</p>
	<p>"Lift Presser Foot To gain access to the next maintenance point, the presser foot must be manually raised. Place a finger below the back bend of the presser foot and lift the presser foot as shown in the image. Press the next button to continue."</p>
	<p>"Grease Upper Presser Foot Cam Follower Using the grease applicator, apply a small amount of the HP grease to the upper presser foot cam follower. Press the next button to continue."</p>




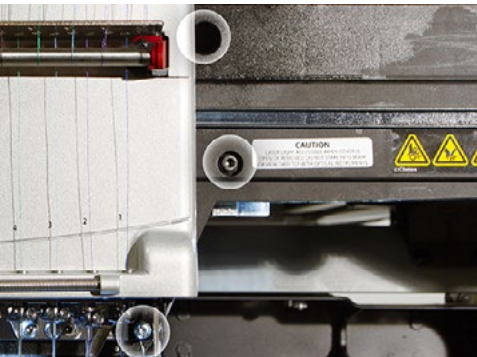
Image	Instructions
	<p>"Reinstall Right Upper Arm Front Cover Position the right upper arm front cover in its original location. You will need to rotate it back into place in the reverse of the way it was removed. Reinstall the five (5) mounting screws to hold the cover in place. It is important to leave them just loose enough that the cover can still move, but make sure that the screws are in far enough that they will not catch the needlecase as it moves over them. The screws will be fully tightened in a future step. Important: Ensure that the button head screw is installed in the lower left side location of the cover as shown in the image. Press the next button to continue."</p>
	<p>"WARNING! If you proceed without mounting the right upper arm front cover, damage to your machine will occur and a service call will be necessary. Note: Melco will not be responsible for any damage to the machine or related service costs caused by not performing this step. When you click the next button, the needlecase will move to the next maintenance position. Click the next button to confirm that you installed the right upper arm front cover and continue."</p>
	<p>"Tighten Screws With the needlecase holding the right upper arm cover in the appropriate position, tighten the two screws in the right side of the upper arm front cover as shown in the image. When you click the next button, the needlecase will move to the next maintenance position. Press the next button to continue."</p>
	<p>"Tighten Remaining Screws Now tighten the three remaining screws on the left side of the right upper arm front cover as shown in the image. Press the next button to continue."</p>

Image	Instructions
	<p>"Clean and Grease Guide With a clean piece of cloth, wipe clean the needle bar guide channel indicated in the image. The image uses cloth wrapped around the grease applicator for better control of the cloth. With a clean piece of cloth, apply a thin film of HP grease to the inside of the channel as shown in the image. When you click the next button, the machine will advance to the next maintenance position. Press the next button to continue."</p>
	<p>"Loosen Left Upper Arm Front Cover Using a 3mm Allen wrench, loosen and remove the four (4) screws shown in the image. Press the next button to continue."</p>
	<p>"Remove Left Upper Arm Front Cover After removing the mounting screws, move the left upper arm front cover slightly away from the machine. Then, rotate it clockwise as shown in the image and remove it completely from the machine. Press the next button to continue."</p>
	<p>"Grease Presser Foot Cam Locate the presser foot cam as shown in the image. With the grease applicator, apply a small amount of HP grease spread fairly evenly along the entire right side of the presser foot cam as shown in the image. Press the next button to continue."</p>

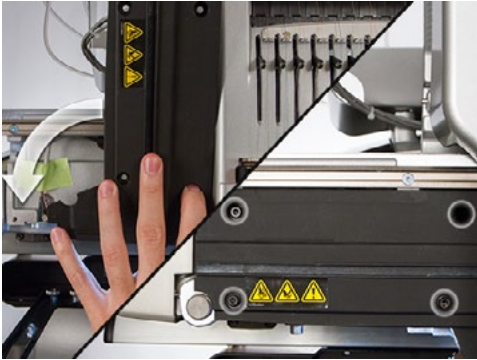
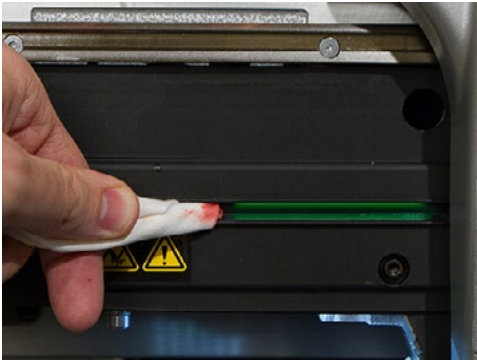

Image	Instructions
	<p>"Reinstall Left Upper Arm Front Cover Position the left upper arm front cover in its original location. You will need to rotate it back into place in the reverse of the way it was removed. Reinstall the four (4) mounting screws to hold the cover in place. It is important to leave them just loose enough that the cover can still move, but make sure that the screws are in far enough that they will not catch the needlecase as it moves over them. The screws will be fully tightened in a future step. Press the next button to continue."</p>
	<p>"WARNING! If you proceed without mounting the left upper arm front cover, damage to your machine will occur and a service call will be necessary. Note: Melco will not be responsible for any damage to the machine or related service costs caused by not performing this step. When you click the next button, the needlecase will move to the next maintenance position. Click the next button to confirm that you installed the right upper arm front cover and continue."</p>
	<p>"Tighten Screws With the needlecase holding the left upper arm cover in the appropriate position, tighten the two screws in the left side of the upper arm front cover as shown in the image. When you click the next button, the needlecase will move to the next maintenance position. Press the next button to continue."</p>
	<p>"Tighten Remaining Screws Now tighten the two (2) remaining screws on the right side of the left upper arm front cover as shown in the image. Press the next button to continue."</p>

Image	Instructions
	<p>"Clean and Grease Guide With a clean piece of cloth, wipe clean the needle bar guide channel indicated in the image. The image uses cloth wrapped around the grease applicator for better control of the cloth. With a clean piece of cloth, apply a thin film of HP grease to the inside of the channel as shown in the image. When you click the next button, the machine will advance to the next maintenance position. Press the next button to continue."</p>
	<p>"Finished! This completes the 30,000,000 stitch maintenance procedure. Press the finish button to exit the maintenance procedure."</p>

Thread Feed Roller Maintenance



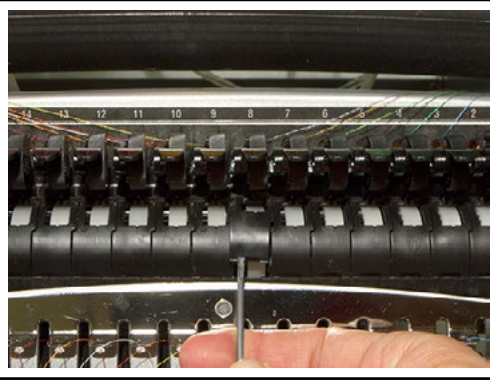
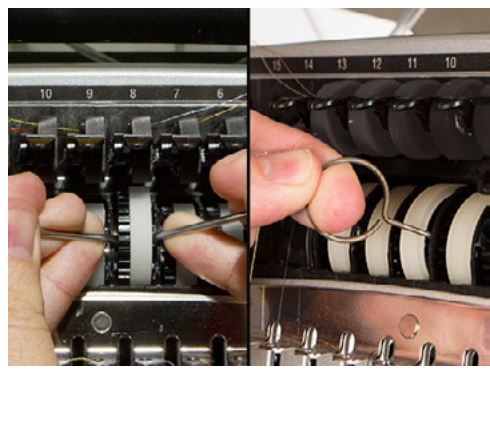
Image	Instructions
	<p>"Please follow all of the maintenance procedures carefully and apply the proper amounts of the specified lubrication during each step. Melco cannot be held responsible for any machine damage due to lack of or wrong type of lubrication. Melco cannot be held responsible for any machine damage due to not following the listed maintenance steps. You will now be guided through the thread feeder maintenance procedure. Press the next button to continue."</p>
	<p>"Lift Pinch Rollers Lift all sixteen (16) thread feed roller arms as shown in the image. Press the next button to continue."</p>
	<p>"Remove Thread Feed Front Covers Although not necessary, it is helpful to move the threads up between the rollers and out of the way. With a small flat blade screwdriver or your fingernail, disengage all sixteen (16) thread feed front covers and remove them from the machine. Press the next button to continue."</p>
	<p>"Remove Thread Feed Rollers Using two thin-bladed flat screwdrivers or the thread feed gear removal tool, carefully pull the thread feed rollers out of the assembly. This can be accomplished by sliding one screwdriver along each side of the roller and prying against your fingers as shown in the image. Set the rollers to the side. They will be cleaned and inspected in future steps. Important: Do not get grease on the thread feed surface of the roller. Press the next button to continue."</p>




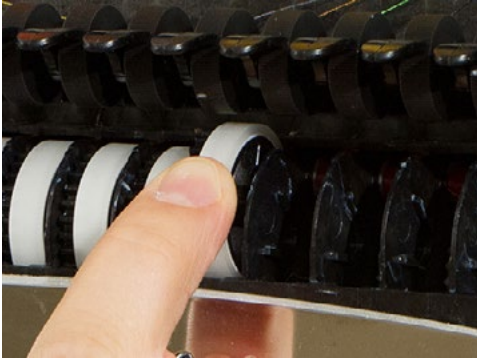
Image	Instructions
	<p>"Clean Assembly Using a clean cloth, remove any lint and old grease from the cradle that holds the rollers. In the image, this is done with the cloth wrapped around the grease applicator for better control of the cloth. Press the next button to continue."</p>
	<p>"Clean And Inspect Rollers Using a clean, dry cloth, thoroughly clean the entire surface of the thread feed roller. Remove any lint or grease. Important: Do not get grease on the thread feed surface of the roller. Inspect the roller for wear, nicks, or grooves that may catch thread. If the roller is damaged, replace it with a new one. Press the next button to continue."</p>
	<p>"Grease Roller Hub Using the image as a guide, apply three (3) small dots of EMB Polymer grease to the side of the hub. Do this for each side of the thread feed roller. Press the next button to continue."</p>
	<p>"Reinstall Thread Feed Rollers Carefully reinstall the thread feed roller. The gear side of the roller should fall to the left. Align the roller with the slot and gently press forward and down until the roller snaps into place. Take care to clean up any grease that may transfer to the front of the slot. Press the next button to continue."</p>

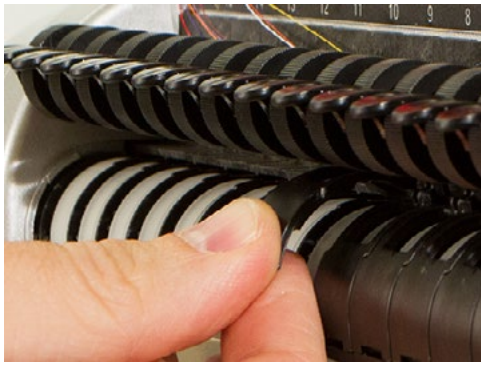
Image	Instructions
	<p>" Reinstall Covers</p> <p>Reinstall the front covers by holding them at the bottom and tilting them up. Insert the top of the cover into the slot at the top of thread feeder assembly. You will probably feel a slight click as it locks into place.</p> <p>Rock the cover forward and down until it snaps into place. Keep in mind that the covers overlap and will reinstall easiest starting with needle 1.</p> <p>Press the next button to continue. "</p>
	<p>" Remove Pinch Rollers</p> <p>Next you need to remove the pinch rollers. This is easiest if you leave the thread feed levers up. Then steady the lever with one hand and pull the roller to the right with the other. This will release it from the hub.</p> <p>Next, lower the lever and angle the roller. It can then be pulled forward and free from the machine. If the lever beside the roller is in the way, gentle pressure may be applied to move it slightly out of the way.</p> <p>Set the rollers to the side. They will be cleaned and inspected in future steps.</p> <p>Important: Do not get grease on the pinch surface of the roller.</p> <p>Press the next button to continue. "</p>
	<p>" Clean Lever Hubs</p> <p>Using a clean cloth, clean all the old grease, lint, and residue from the lever hub. In the image, the cloth was wrapped around the grease applicator for better control.</p> <p>Press the next button to continue. "</p>
	<p>" Clean Pinch Rollers</p> <p>Using a clean, dry cloth, thoroughly clean the entire surface of the thread feed roller. Remove any lint or grease.</p> <p>Important: Do not get grease on the pinch surface of the roller.</p> <p>Inspect the roller for wear, nicks, or grooves that may catch thread. If the roller is damaged, replace it with a new one.</p> <p>Press the next button to continue. "</p>

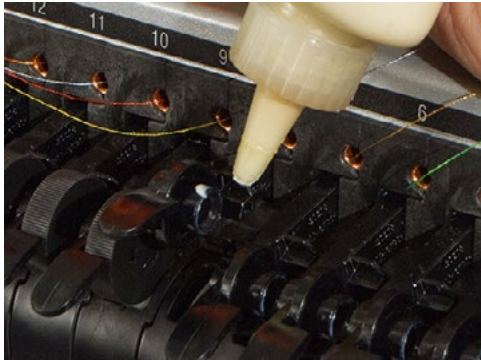
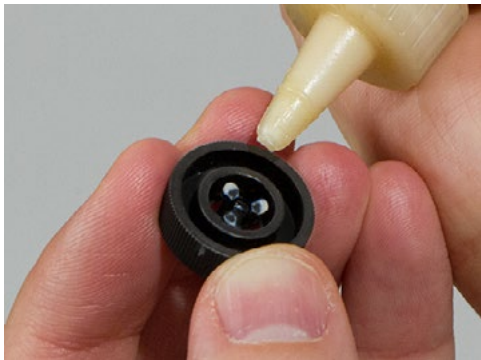
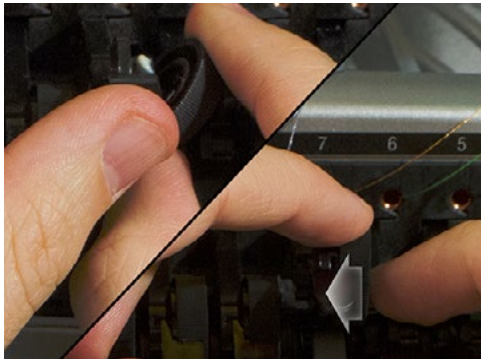
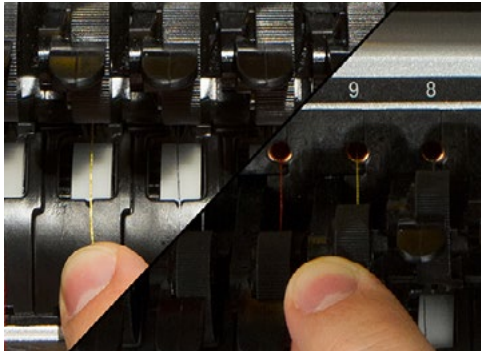

Image	Instructions
	<p>"Grease Lever Hub Using EMB Polymer grease, apply a small amount of grease to the lever hub as shown in the image. Press the next button to continue."</p>
	<p>"Grease Pinch Rollers Using EMB Polymer grease, apply a tiny amount of grease to the outer surface of one (1) of the three (3) small pegs inside the pinch roller as shown in the image. Press the next button to continue."</p>
	<p>"Reinstall Pinch Rollers With one lever up and one lever down, hold the pinch lever at an angle and slide it back into place. Rock it back onto the hub and slowly rotate to begin spreading the grease evenly around the hub. Snap the roller back onto the hub and spin the roller to ensure that it is locked into place and the grease is spreading evenly. Press the next button to continue."</p>
	<p>"Align Threads If you moved the threads originally, move them back into place. Align the threads onto the v-notch in the front cover and lower thread feed levers. Press the next button to continue."</p>

Image	Instructions
	<p>"Finished! This completes the quarterly maintenance procedure. Press the finish button to exit the maintenance procedure."</p>

Thread Break Troubleshooting

Thread breaks are an irritating part of embroidery, but they do not have to be merely tolerated. By following a few steps when rethreading the needle, you can begin to diagnose the nature of the thread break and hopefully avoid a subsequent one.

Diagnosing a Thread Break

Following a diagnostic method when rethreading a needle is a good way to eliminate the simplest and most common causes of thread breaks. Start with the following steps. Each step is explained in more detail in the following sections..

After the first thread break,

1. Check the upper thread path.
2. Check the bobbin tension.

Rethread the machine and sew. If a second thread break occurs in a relatively short time,

3. Check the needle.
4. Check the presser foot height.
5. Check the acti-feed settings in the software.

Rethread the machine and sew. If a third thread break occurs in a relatively short time, you may need to contact Technical Support or utilize the next sections to help determine the cause.

6. Use the Thread Break Diagnostic Table below to begin a more thorough analysis.

Thread Break Diagnostic Table

Sections containing information about each of the possible solutions follow the table.

Symptom		Possible Solutions	
Real Top Thread Break (this design only)	Thread breaks on this material/garment only.		<ul style="list-style-type: none"> • Check for application specific issues like specialty thread or needle type. • If the application information does not help, contact Technical Support.
	Thread breaks on all materials/garments.	Thread breaks on the start or end of elements.	<ul style="list-style-type: none"> • Check the tie stitches of the design. • Check the bobbin tension and tail length. • If the items above do not help, contact Technical Support.
		Thread breaks mostly on lettering.	<ul style="list-style-type: none"> • Avoid doubling tie stitches. • Make sure the stitches are long enough to sew well. • Check the density settings. Lettering that is too dense will not sew smoothly. • If the items above do not help, contact Technical Support.
		Thread breaks mostly in the corners.	<ul style="list-style-type: none"> • Try capping or mitering the troublesome corners. • If that does not help, contact Technical Support.
		Thread breaks all over the design.	<ul style="list-style-type: none"> • Check for stitches that are too small to sew well. • Check the density settings. Designs that are too dense will not sew smoothly. • Has the design been scaled too far? • Check for too many needle penetrations in a concentrated area. • Check for application specific issues like specialty thread or needle type. • If the items above do not help, contact Technical Support.
False Top Thread Break			<ul style="list-style-type: none"> • Check your Acti-feed settings. • Check your presser foot adjustment. • Check your bobbin tension. • Check for thread buildup under the needle plate. • If the above items did not work, contact Technical Support.

Symptom		Possible Solutions
False Bobbin Break		<ul style="list-style-type: none"> • Check your Acti-feed settings. • Check your presser foot adjustment. • If the above items did not work, contact Technical Support.
Real Bobbin Break		<ul style="list-style-type: none"> • Check the bobbin tension. • Clean the bobbin case. • Check the bobbin case for damage. • Use continuous filament polyester bobbin thread. • Check for an over-wound bobbin. • If the above items did not work, contact Melco Technical Support.
Real Top Thread Break (all designs)	Thread breaks on one needle only.	<ul style="list-style-type: none"> • Change the needle. • Check the needle orientation. • Change the cone of thread. Some cones can become damaged and prevent smooth sewing. • Check for application specific issues like specialty thread or needle type. • If the items above do not help, contact Technical Support.
	Thread breaks on all needles.	<ul style="list-style-type: none"> • Check the presser foot adjustment. • Check the actifeed settings. • Check the bobbin tension. • Check for application specific issues like specialty thread or needle type. • Clean under and center the needle plate. • Check the rotary hook support. • Reset the machine (described in a later section). • If the items above do not help, contact Technical Support.
Missed Trim		<ul style="list-style-type: none"> • Check the tie stitches of the design. • Check your Acti-feed settings. • Clean underneath the needle plate and ensure that it is centered. • If the above items did not work, contact Technical Support.

Symptom	Possible Solutions
Missed Start	<ul style="list-style-type: none">• Check the needle orientation.• Check the tie stitches of the design.• Check the acti-feed settings.• Check the bobbin tension and tail length.• If the above items did not work, contact Melco Technical Support.
Bird Nest (mass of thread under the needle plate)	<ul style="list-style-type: none">• Make sure the thread is lined up under the pinch roller.• Clean and grease the pinch rollers.• Check the rotary hook support.• Clean underneath the needle plate and ensure that it is centered.• If the above items did not work, contact Technical Support.

Thread Breaks From Machine Issues

Troubleshooting the Upper Thread Path

The upper thread path should run smoothly the entire way from the cone of thread through the eye of the needle. If there is a rough spot or the thread does not follow the proper path, thread breaks are more likely. Look for the following issues when troubleshooting a thread break.

- Thread Does Not Follow Proper Path
- Damaged Cones of Thread (Bruised Cones)
- Rough Spot in the Thread Path
- Thread Wrapped Around Thread Tube
- Thread Pulling Across Top of Cone
- Thread Pooling Below Cone

Thread Does Not Follow Proper Path

If it is wrapped around the thread tube or missing from one of the thread guides, it will not sew as reliably.

As you are rethreading the machine from a thread break, make sure that the thread follows the proper path. See how in the upper threading section.

Damaged Cones of Thread (Bruised Cones)

While not the most common cause of thread breaks, damaged cones can create issues for embroiderers. If a cone has been dropped, the threads may have shifted. This can cause the thread to cast off the cone less freely and create thread breaks.

As you rethread the machine, pull on the thread with the pinch roller up and see how it pulls. If the cone is damaged, it may pull easily for a bit and then feel as though it is being pulled across sandpaper. This can cause thread breaks.

The age of the thread and exposure to the elements can also weaken thread. Storing your thread where it is shielded from the elements and light can help prolong the life of your thread.

Change to a different cone of thread. Some cones can be saved by casting off thread until you are past the damaged part of the cone.

Rough Spot in the Thread Path

Check along the thread path for any rough areas. You may find that the cone of thread has a rough spot on the plastic core. This can catch thread as it is being cast off and fed through the machine.

Remove any rough spots from the plastic core with a fine sand paper or emery board.

Thread Wrapped Around Thread Tube

If the thread wraps around the thread tube at the top of the cone, the thread will most likely break. This is usually caused from the thread tube being extended too far above the cone.

Adjust the thread tube to extend just above the cone. Extend it about ½”.

Thread Pulling Across Top of Cone

As thread casts off and runs through the system of the machine, it pulls through the thread tube quickly. If the thread tube is not extended far enough above the cone, the thread can pull across the top of the cone and create thread breaks.

Adjust the thread tube to extend just above the cone. Extend it about ½”.

Thread Pooling Below Cone

If the thread cones are not properly seated on the thread tree of the machine, vibration from the machine can cause the cones to spin and/or the thread to cast off and puddle at the bottom of the cones. As thread collects below the cone, it can catch before being fed into the machine. This can cause extreme tension on the thread and cause the thread to snap.

If using larger cones, be sure to sit the cone snugly on the thread tubes. If the cones wobble, install a thread clover on the thread tube before loading the cone of thread. The clover will expand inside the cone and prevent it from wobbling.

If using smaller spools of thread, you may need to use a thread cone/spool holder to prevent the thread casting off from falling under the spool base.

Troubleshooting the Bobbin Thread

Thread breaks can occur from issues with the bobbin. To ensure that the bobbin is not the problem, look for the following issues when troubleshooting thread breaks.

- Wrong Type of Bobbin
- Bobbin Thread is Low or Out
- Bobbin is Over-wound
- Bobbin Case Not Properly Inserted into the Machine
- Bobbin Tail Too Short
- Improper Bobbin Tension or Dirty Bobbin Case
- Damaged Bobbin Case

Wrong Type of Bobbin

The machine uses a style L bobbin. Attempting to use a different style would be difficult and could produce many problems.

Using spun polyester bobbins can also cause some thread break issues. Spun polyester bobbins are created by spinning multiple polyester fibers together. This creates a fuzzier thread that pulls less smoothly through the system and generates a good deal more lint.

Use Style L continuous polyester filament bobbins.

Bobbin Thread is Low or Out

As bobbins unwind, the tension can become inconsistent. This can cause bobbin tension that is too loose or too tight. That can result in bobbin pulling through to the top of the design or thread breaks. It can also result in bobbin breaks.

Change to a new continuous filament polyester bobbin.

Bobbin is Over-wound

Some pre-wound bobbins are over-wound and become big enough to apply pressure to the bobbin case. This creates resistance as the bobbin attempts to spin. This resistance can mimic a bobbin tension that is too tight and produce thread breaks and misstarts.

Cast off bobbin thread before loading the bobbin into the bobbin case or try a new bobbin.

Bobbin Case Not Properly Inserted into the Machine

If the bobbin case is not inserted properly in the machine, the machine cannot form a complete stitch. A loose bobbin case will rattle and can cause thread breaks and needle breaks.

If the bobbin case is not inserted at all, the machine cannot create a stitch. The thread will usually get caught on the central shaft of the rotary hook. You will also commonly hear a popping sound before the thread break.

Remove the bobbin case and insure that the rotary hook is clean. Clean the area with a brush or canned air. Then, with the pigtail in the twelve o'clock position and the bobbin facing the machine, insert the bobbin case into the rotary hook. If the lever on the case is not used, you can hear the bobbin case click into place. See how in the bobbin threading and tensioning section.

Bobbin Tail Too Short

If the thread breaks are occurring mostly as the machine is starting, the problem could be misstarts from the bobbin tail being too short when the bobbin case is inserted into the machine. Ideally, the bobbin tail should be two to three inches long. Longer tails can wrap up in the machine. Shorter tails may not allow for a stitch to catch when starting the machine.

When inserting the bobbin case into the machine, trim the tail to two to three inches in length.

Improper Bobbin Tension or Dirty Bobbin Case

Bobbin tension that is too tight can cause thread breaks, misstarts, puckering, and design registration issues.

Bobbin tension that is too loose can cause bobbin pull to the top of the design.

A dirty bobbin tension spring can mimic any of the problems above. If lint is caught under the tension spring and the spring is over-tightened to compensate, the tension spring may become damaged and the case may need to be replaced.

Clean and properly tension the bobbin case. See how in the bobbin threading and tensioning section.

Damaged Bobbin Case

The bobbin case that holds the bobbin must maintain its original shape. If dropped, the bobbin case may have bent and is no longer round. This will apply uneven pressure on the bobbin and create uneven tension.

Replace the bobbin case with a new one.

Troubleshooting Designs

How a design has been digitized can greatly affect how it sews. Testing against a standard test design is a good way to tell if the design you've been trying to sew is actually the cause of your thread breaks.

Sew the test design on a swatch of broadcloth and a couple pieces of cut-away backing. If the test design sews well, but the problem design does not, there is a good chance that the design is the issue.

When diagnosing design issues, it is helpful to pay attention to where the thread breaks are occurring.

- Thread Breaks Occur at the Beginning or End of Elements
- Thread Breaks in the Corners of Elements
- Thread Breaks on the Lettering
- Thread Breaks All Over the Design

Thread Breaks Occur at the Beginning or End of Elements

How the design ties in and ties off the elements will affect how the stitches start and trim. If these ties are not appropriate, thread breaks and mistrims can occur.

Check your tie ins and tie offs.

Thread Breaks in the Corners of Elements

As stitches navigate around corners, it can be common for them to bunch up and cause puckering, thread breaks, and even holes in the garment. Changing how the stitches handle corners can smooth these problems out.

Cap or miter the corners of elements.

Thread Breaks on the Lettering

Lettering that is added to a design can have different settings that will change how the lettering sews. Stitches may be smaller than your needle, densities may be too tight, and with some keyboard alphabets, tie stitches may have been doubled up. All of these problems can cause thread breaks.

To address these issues, you'll need to check:

- Tie ins and tie offs (Avoid double ties)
- Density settings
- Smaller stitches - Use "Pull Offset"

Thread Breaks All Over the Design

If thread is breaking everywhere in the design, and the test design sews well, it could be that the design is too dense, there are too many needle penetrations in concentrated areas, or perhaps the design was scaled down too far.

To address these issues, you'll need to check:

- Density settings
- Scaling a Design
- Stitch Proximity

Troubleshooting Tie Stitches

Tie stitches are small grouping of stitches at the beginning and end of embroidery elements. Their purpose is to lock the thread in place and prevent it from pulling out when the machine starts sewing or trims. Setting tie stitches appropriately for the design will help keep the design running smoothly as well as stay in the garment after laundering.

Watch for the following issues when working with tie stitches:

- Misstarts Caused by a Lack of Tie Stitches
- Manually Digitized Tie Stitches
- Tie In/Tie Off Property
- Mistrims Caused by Doubled Tie Stitches
- Removing Digitized Ties From Alphabets
- Use the Tools>Settings>Machine Tab to Enable Tie In / Tie Off. This will optimize the ties stitches in the design.

Misstarts Caused by a Lack of Tie Stitches

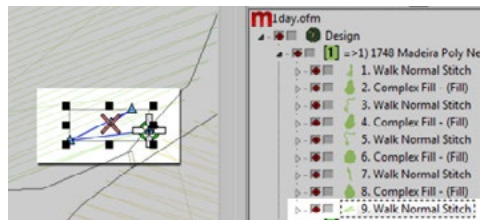
Thread breaks, or at least what look like thread breaks, can be caused from a lack of tie stitches. A lack of tie stitches will often cause the thread not to catch as the machine starts to sew. The needle may even come unthreaded. The machine will detect this as a thread break when it is really a missed start.

In DesignShop, ensure the design contains tie stitches.

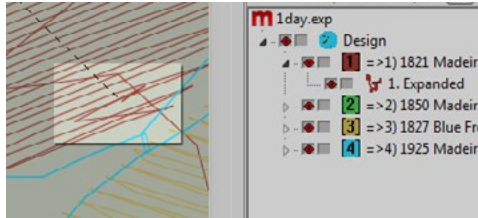
Manually Digitized Tie Stitches

In wireframe files, you may find tie stitches in the form of manually digitized small walk normal or manual stitch elements at the beginning and end of an element. This is typical of older designs or designs from digitizers who may have started digitizing in older versions of software.

If you zoom in on the last element of a color, you may see these few stitches going back and forth across each other. If you don't see these, check the properties of the project for tie stitches.



In expanded stitch files, these tie stitches are a bit harder to see because you cannot just select the last element before a trim.



Tie In/Tie Off Property

The properties window of DesignShop allows you to automatically add tie stitches to a wireframe design. To ensure that a wireframe design has tie stitches:

Select the design in the project view and open the Object Properties window.

With “All Elements” selected in the properties drop-down menu, select the Tie In And Tie Off.

Placing check marks in the “Tie In” and “Tie Off” boxes will add tie stitches to the beginning and/or ending of a digitized element.

Choosing “Only When Necessary” from the “When To Tie” drop-down menu will add the tie stitches only when at a trim command or the beginning or end of the design. Choosing “Always” will add tie stitches to the entry and exit of every element.

Clicking Apply and OK will apply the changes to the object properties.

Tie stitches applied through the object properties window can also be seen in the stitches tab as “TI” or “TO” (Tie In or Tie Off).

The ideal tie stitch for the machine is most often style 1 with a width of 6 points and the number of stitches set to “Default”. This creates a nice small stitch pattern that adjusts how aggressive the tie stitch is based on the length of the stitch line. Since longer stitch lines usually require more aggressive tie stitches, this works well for most applications.

Mistrims Caused by Doubled Tie Stitches

Using object properties to add tie stitches to designs or embroidery alphabets that already contain manually digitized tie stitches will double them up. Doubling tie stitches will often cause thread breaks and/or mistrims.

Do not use object properties to designs or embroidery alphabets that already contain manually digitized tie stitches.

Before adding tie stitches, look for manually digitized tie stitches in older files like those described above. If using older alphabets in DesignShop, check the alphabet information to prevent doubling tie stitches. As only some of the alphabets contain tie stitches, this is an important step in creating smooth-sewing lettering.

Removing Digitized Ties From Alphabets

The manually digitized tie stitches on the older embroidery alphabets may be removed so that object properties may be used on all the alphabets in DesignShop. To do that, go to the Tools menu and select Convert Alphabets....

From the Convert Alphabets window, click on Remove Ties to remove the manually digitized tie stitches from all of the installed alphabets.

Use The Software Features to Address Tie Stitches

Both DesignShop and Melco OS contain features that will allow you to easily optimize the locks (tie stitches) of a design. It will scan through a design and remove tie stitches, if there are any, and replace them with optimal ties for the design. The design filter works well for both wireframe and stitch files.

To use this filter in Design Shop, go to Tools, then Filters, and select Design Filter.... In the design filter window, check "Optimize Locks". Next click Filter and Adjust Now. Click OK to close the window.

For Melco OS, go to Tools, then select Options. In the Machine Tab, check "Enable Tie In / Tie Off". Click OK and load the design again for the filter to work. Once checked, the feature will stay on until unchecked. This means that every design to be loaded in the software will be filtered and have the ties altered or added. This is a good option if you are uncertain how to handle tie stitches.

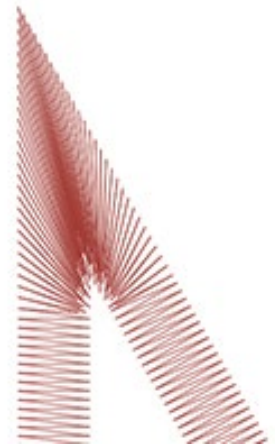
Troubleshooting Corners

The problem of thread breaks in corners arises as stitches navigate around corners. It can be common for them to bunch up and cause puckering, thread breaks, and even holes in the garment. Notice the dark area of stitches in the example. Such tight stitching is problematic.

Changing how the stitches handle the tighter angled corners can smooth these problems out.

Look at the following examples to prevent sewing issues in the corners.

- Capping the Corners
- Mitering Corners
- Variations On Miters
- Corners On Singleline Elements

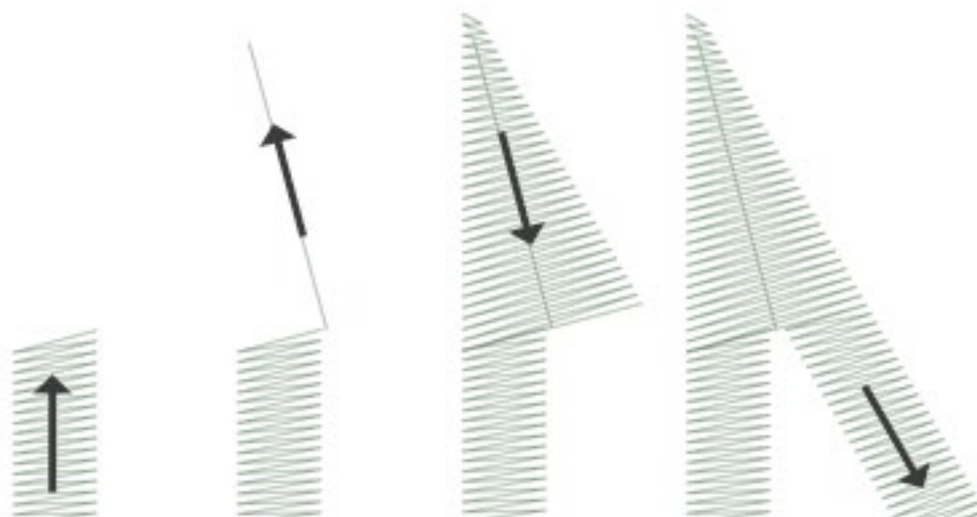


Capping the Corners

Capping the corners is a way to keep the stitches in a consistent direction and maintain an even stitch spacing. The drawback of capping comes from the limited range of use. Larger corners should not be capped as longer satin stitches are prone to snagging and becoming loose. Try to avoid creating satin stitches longer than 6 - 7 millimeters in length.

To cap a corner,

1. Use a satin stitch element to sew to the inside edge of the corner.
2. Use a walk stitch to travel to the tip of the corner.
3. Use a second satin stitch element to sew back to the inside edge of the corner.
4. Use a third satin stitch element to sew the last leg of the corner.



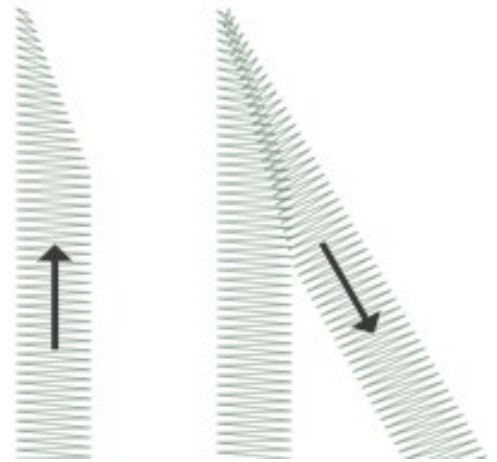
Mitering Corners

Mitering corners is another way to keep the stitches in a consistent direction and maintain an even stitch spacing. Mitering works well for less extreme angles and wider satin stitches.

To miter a corner,

Use a satin stitch element to sew to the inside edge of a corner. Continue the element but taper the end from the inside of the corner to the point. Be sure to leave enough of the edge under the corner to create an overlap with the second element.

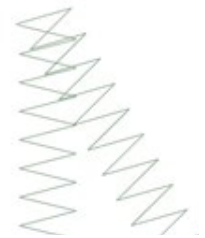
Use a second satin stitch element to sew from the point to continue to the second leg of the corner. The inside edge of the element should create a seam from the tip of the point to inside of the corner.



Variations On Miters

Miters can and should be altered to adapt the size of the design and the application. A complete overlap may work well for smaller elements that do not have the room to taper before becoming smaller than a needle. This is also typical of traditional tackle twill tack-down stitches.

This type of corner is also common on small lettering.



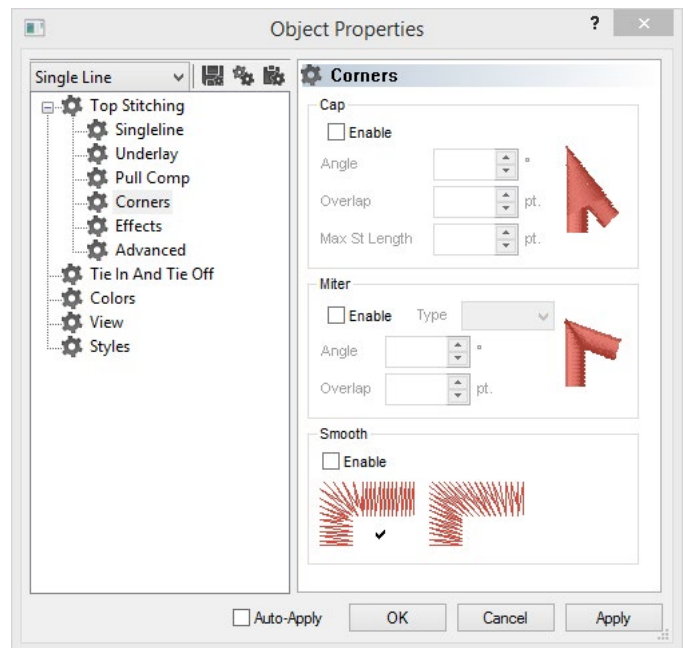
Corners On Singleline Elements

Singleline column elements have a “Corners” property. This object properties submenu will allow you to choose how that element handles corners.

You can choose to have the corners cap or miter. With miter, you have the option of type 1 or type 2. Type 1 is the miter that comes to a point. It is the first example of a miter shown above. The example shown under “variations” is a type 2 miter.

With the cap and the miter, you can choose at what angle the special corner should occur. You can also choose an overlap amount.

The “Corners” property is available in the higher levels of DesignShop.



Stitches Too Small

Some designs may contain elements with stitches that are too small to sew reliably well.

DesignShop will begin filtering out every other stitch that falls below five points in length. This will help alleviate the issue, but it may not solve it completely.

Look for the following if your design is having thread breaks on thin outlines or small elements or lettering.

- Stitch Size vs. Needle Size
- Thread Breaks On Small Satin Stitches
 - Edit the Smaller Areas Manually
 - Use Pull Offset to Lengthen Stitch Lines
 - Use Minimum Column Width to Prevent Thread Breaks
 - "Short Stitches"
- Thread Breaks on Walk Stitches
 - Use Fewer Input Points

Measurement Units - What's a Point?

Points are a very fine unit of measure found in the embroidery industry and represent a tenth of a millimeter.

For a reference:

10 points = 1 millimeter

100 points = 1 centimeter

254 points = 1 inch

Stitch Size vs. Needle Size

As a general rule, it is best to keep stitch lengths longer than the diameter of the needle you are using to sew them. Because most needles are between 7 and 8 points in diameter, for most applications and designs, try to keep stitches 10 points long or longer.

Ideal minimum stitch lengths would be:

- Walk Stitches \geq 15 points
- Satin Stitches \geq 10 points
- Fill Stitches \geq 20 points

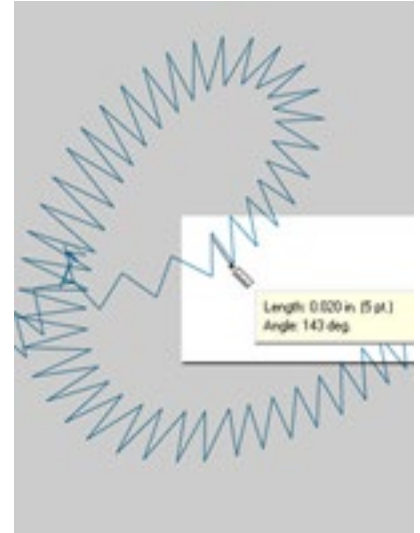
These values may be altered if the application or design dictates, but they are good general minimums.

Thread Breaks On Small Satin Stitches

If thread breaks are occurring on small satin stitches or on small lettering, it could be that your stitches are smaller than the needle that you're using. This can cause some thread breaks. To find this problem areas, use the ruler tool in DesignShop to measure the stitches in the thinnest satin stitch areas. If you find that the stitches are less than ten points or one millimeter wide, you will most likely need to address that area.

Widen the smaller stitch areas to better accommodate the needle and sew with few thread breaks. This can be done a few ways.

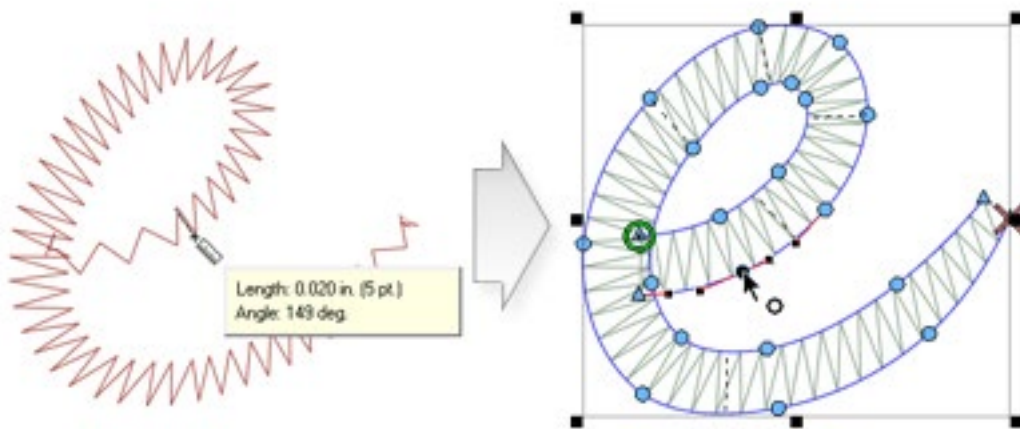
- Edit the small areas to widen the stitches.
- Use Pull Offset to widen the stitches.
- Use minimum column width to prevent any satin stitch from falling below the specified amount.



Edit the Smaller Areas Manually

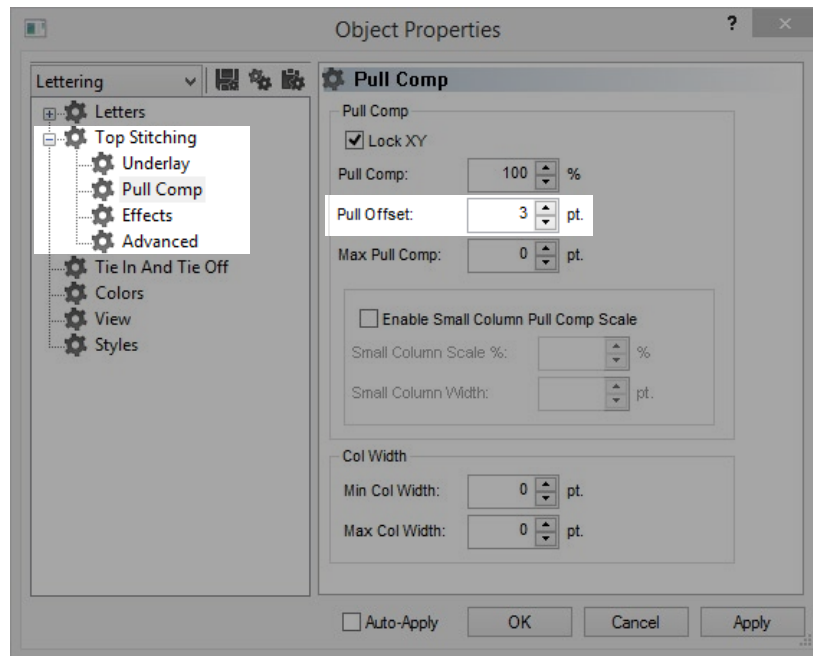
The smaller area of stitches may be edited manually. If the file is an OFM or in wireframe format, you can edit the edges of the wireframe elements to allow for longer stitches.

Use the ruler tool to find the smaller areas of the design. Then, using wireframe edit mode, move the input points to widen the column and lengthen the stitch lines.



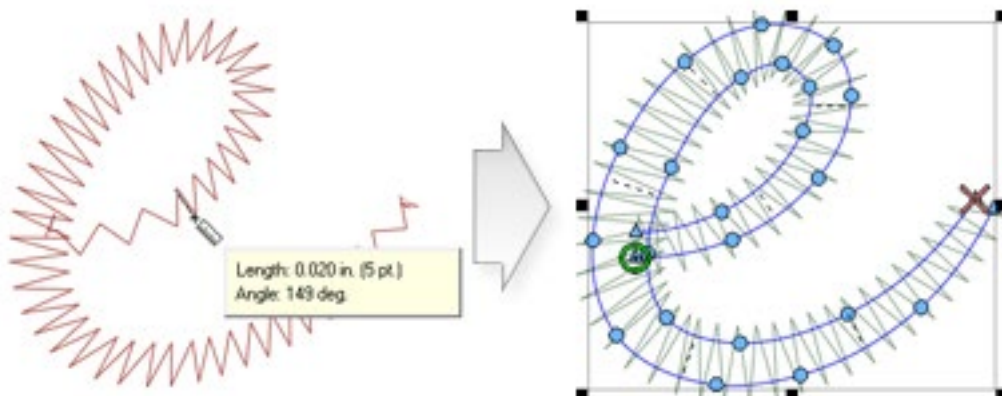
Use Pull Offset to Lengthen Stitch Lines

To modify larger areas of designs, it might be more helpful to use pull offset. Pull offset is found in object properties under the "Pull Comp" sub-menu.



Pull offset extends the stitch lines of an element by adding the specified amount to each side. If the element was 5 points wide at the thinnest point, a "3" could be entered into the pull offset field to extend the stitch lines by three points on each end. This would create an element that at the thinnest point is now 11 points wide and thick enough to sew without breaking a thread.

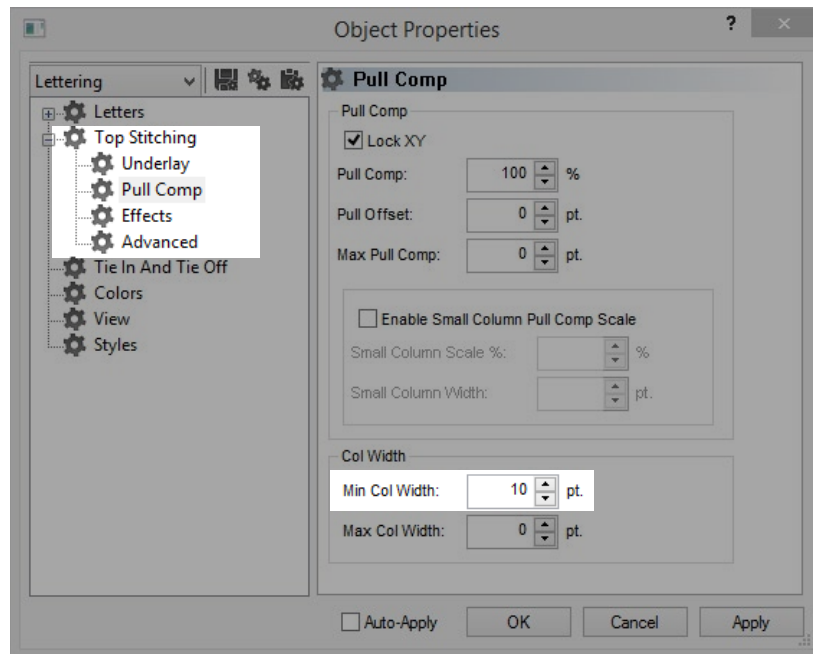
Because pull offset extends each end of the stitch line, adding 3 to each side of a 5 point satin stitch will give you an 11 point satin.



Use Minimum Column Width to Prevent Thread Breaks

Another way to prevent tiny satin stitches from giving you thread breaks is to use the “Minimum Column Width”. This feature will prevent any multi-stitch line element (columns or fills) from creating a stitch less than the specified amount.

Found in object properties under “Pull Comp”, placing a “10” in the “Min. Col. Width” field can help prevent thread breaks on more questionable designs.

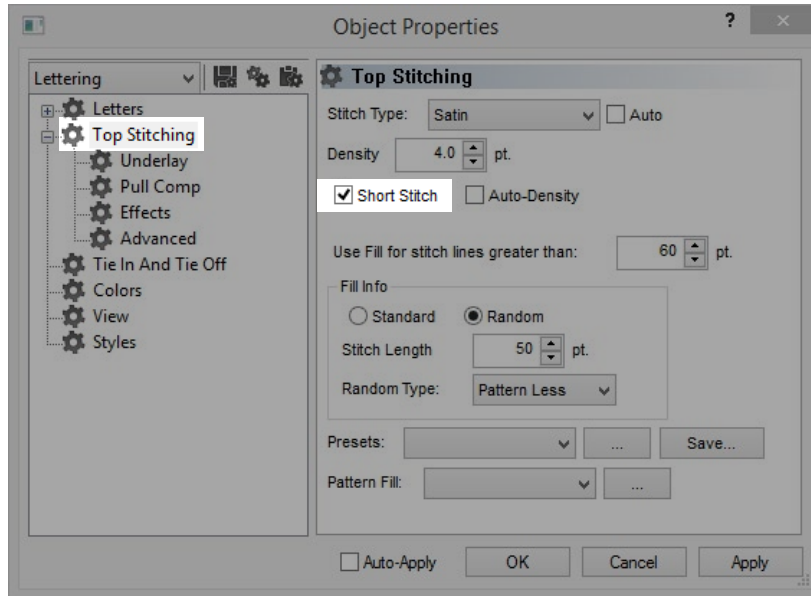


“Short Stitches”

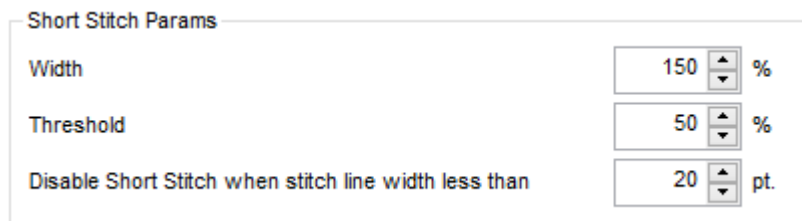
“Short Stitches” is a feature that alternates the length of stitches on the inside of curves and sharper angles. It is meant to prevent thread breaks, thread build up, and damage to garments in those tighter areas.



Newer versions of DesignShop have this feature on by default.



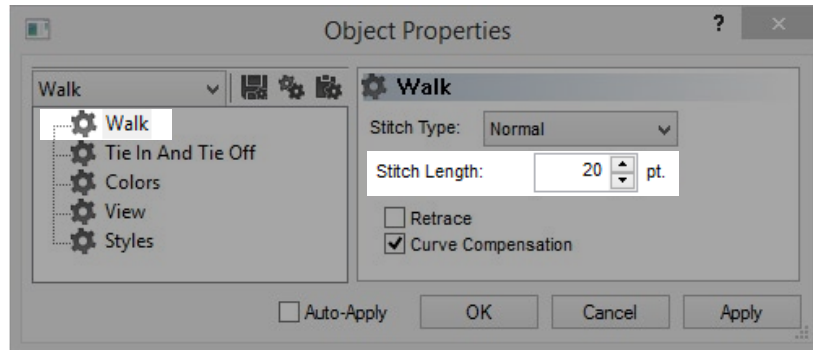
While this feature is beneficial most of the time, it can cause stitches that are too small in smaller lettering or narrow satin stitches. For that reason, since DesignShop V9, a new parameter has been added to the short stitch properties. It will automatically disable for stitch lines shorter than a specified amount. This is set to 20 points by default and should work well for most designs. These parameters can be found under the “Advanced” sub-menu.



With designs saved in older versions of software, these parameters may need to be checked.

Thread Breaks on Walk Stitches

If walk stitches are the problem area of a design, it could be that the stitch length is just set too short. Try to avoid a stitch length of less than 15 points.



Use Fewer Input Points

Probably the most common cause of thread breaks on walk stitch elements from digitizing is using too many input points in a small area. Every input point that is created also creates a needle penetration.

Many new digitizers try to use more input points to help a walk input element follow a line in the artwork. Try to use fewer points to create the same shape. It will decrease the stitch count, allow the design to be more easily edited, and help prevent stitches that are shorter than the diameter of the needle.

Also try to keep at least 10 points (1 mm) between the input points.

Troubleshooting Density

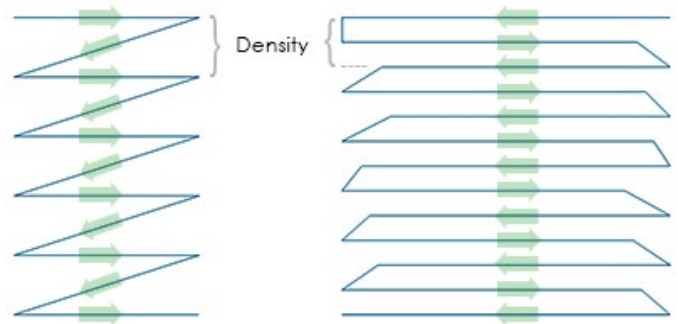
The density of the stitches in a design can also lead to thread breaks. This usually occurs from one of the following.

- Density Setting is Too Tight
 - What is an Ideal Density Setting?
- Too Many Layers of Stitches
- Needle Penetrations are too Concentrated
 - Stitch Proximity Plot
 - Stitch Proximity Filter

Density Setting is Too Tight

The density setting in DesignShop represents the distance between stitch lines going the same direction. In some ways, it may be helpful to think of it as stitch spacing. The larger the number is, the farther apart the stitch lines will be.

If the stitches are too close together, it can cause friction and thread breaks as well as causing rippling and poor sew quality.

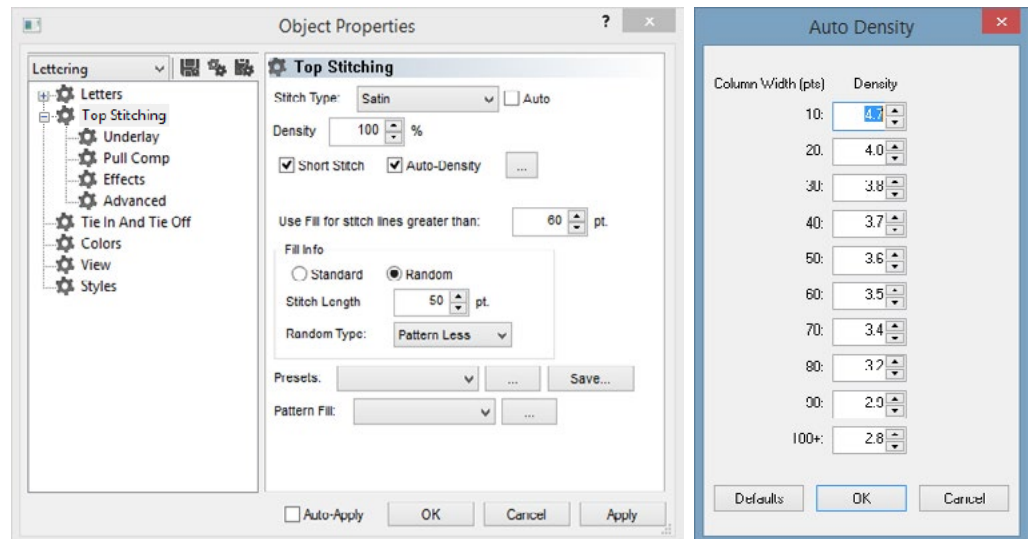


What is an Ideal Density Setting?

Density settings will need to be changed to accommodate different stitch types and applications. Finding an appropriate setting may take some experimentation. Good starting points are found in the software.

For satin stitches:

Consider using “Auto Density”. Auto density is a setting that will vary the density based on the length of the stitch lines. The longer a stitch is, the more it stays up out of the material. For that reason, longer stitches or wider columns often require tighter densities with the stitches closer together. This keeps the stitches even and looking nice.



For fill stitches:

One density setting should work well throughout a fill. Fill stitches are usually comprised of a series of identical stitch lengths. A standard density setting of 3.8 points should work fairly well as a starting point for most fills. This setting may need to be adjusted for different stitch lengths, fill patterns, and applications.



Specialty threads and applications often require altering density settings. The manufacturers' websites are good places to find recommended design and sew settings.

Too Many Layers of Stitches

Building up multiple layers of stitching can also lead to density issues. Too many stitches packed into one place can create a tough or stiff patch of stitches. This will often lead to friction and thread breaks as another layer of stitching is applied on top.

In designs that require layers of stitches, each layer will need to have a lighter density setting so that when all the layers are built up, they reach an overall stitch density close to that of a single normal fill.

Needle Penetrations Are Too Concentrated

If multiple design elements line up in one area, it can create a concentration of needle penetrations. This concentration can create holes in a garment as well as thread breaks.

Avoid overlapping design elements with needle penetrations that are concentrated in a small area.

Stitch Proximity Plot

DesignShop can plot out the needle penetrations and color code the concentrations. To use this tool, go to Tools > Filter > Stitch Proximity Plot.... Then, hide the stitches in your design. Behind the design you will see the proximity plot. It resembles a weather map. The dark areas are your possible trouble areas, and the lighter areas should give you little trouble.

Stitch Proximity Filter

The Stitch Proximity Filter will slightly adjust the needle penetrations in the most concentrated areas to help alleviate the troublesome areas in a design. To use the filter, go to Tools > Filter > Proximity Filter....



Using this filter will convert all wireframe data to expanded, making future editing or scaling difficult.

Troubleshooting the Needle

Proper needle orientation is essential to producing a proper stitch. If the needle orientation is incorrect, the loop of thread that is created while making a stitch may not be in the appropriate location to be caught by the rotary hook to complete the stitch.

A damaged needle can also cause thread breaks.

Look for the following items when diagnosing a thread break.

- Needle Angle Out of Range
- Needle in Backwards
- Damaged Needle

Needle Angle Out of Range

Ideally, the eye of the needle should be 5° to the right of center when sewing. There is an acceptable range of 0° - 20° to the right, but 5° is the absolute ideal. The chance of thread breaks increases if the needle orientation is outside of the acceptable range.

As a visual reference, think of a minute on a clock face as being 6° .

Adjust the needle orientation to have the eye of the needle 5° to the right. For more help, see the needle replacement section.



Needle in Backwards

Embroidery needles have a front and a back side. If you install the needle in backwards, you will most likely encounter thread breaks within the first few stitches after starting a design.

The front of the needle has a long groove (thread guide), while the back has an indented notch (scarf) just above the eye of the needle.

Reorient the needle to have the thread guide to the front, the scarf to the back, and the eye of the needle to be 5° to the right. For more help, see the needle replacement section.



Damaged Needle

Standard needles last approximately 4 to 6 solid sewing hours. After this time they begin to wear out. Burs may form on the needle or they become dull and cause thread breaks.

Replace the needle. For more help, see the needle replacement section.

Troubleshooting the Presser Foot

Proper presser foot height can contribute greatly to the sew quality of the machine. Look for the following issues when troubleshooting a thread break.

Presser Foot Set Too High

If the presser foot is set too high, you may see more material movement and a loss of design registration. This is often accompanied by thread breaks.

Stop the machine and adjust the presser foot. See how in the presser foot section.

Presser Foot Set Too Low

While rarely does this create a thread break, having the presser foot too low can increase the sound of the machine as it sews. It can also create a faint light halo around the design on a dark garment. This halo can usually be removed with steam, water, or a light ironing aid.

Stop the machine and adjust the presser foot. See how in the presser foot section.

Troubleshooting Scaled Designs

Whether wireframe or expanded, scaling a design too far can lead to thread breaks.

Shrinking Designs

Scaling a design down can produce thread breaks by creating stitches smaller than the diameter of the needle. When wireframe designs are scaled down, all the input points are moved closer together. Since each input point results in a needle penetration, this can create stitches that are too small.

How Much is Too Much?

How far you can scale a design depends on the type of file as well as the amount of detail in the design. If the design is relatively simple, your chances of scaling success are better than a design with a good deal of small detail.

As a general rule,

- Expanded designs should be scaled only around 10-15% from their original size.
- Wireframe designs should be scaled only around 25-30% from their original size.

Some designs may be scaled beyond these limits, but the success of the sewout will depend on how the design was originally digitized. Embroidery designs are rarely capable of being scaled to fit all needs.

Troubleshooting Application Thread Breaks

Different sewing applications may cause thread breaks and other sew quality issues. Look for the following when diagnosing an application problem.

- Embroidering Abrasive or Coated Materials
- Is the Needle Size Appropriate for the Design?
- Is the Backing Appropriate for the Material?
- Is the Design Appropriate for the Material?
- Are You Using Adhesives?
- Is the Garment Hooped Properly?
- Are You Using Specialty Threads?

Embroidering Abrasive or Coated Materials

Course or rough materials can cause friction on thread and create thread breaks. Using a larger needle will create a bigger hole and reduce the friction on the thread. This can be helpful on materials like heavy canvas or cotton duct.

On abrasive materials, use a larger needle like an 80/12 to alleviate thread breaks.

Coated and water-resistant materials like some computer bags can heat up a needle and begin to melt as the needle moves through the material. This melted material can gum up a needle making it more prone to thread breaks and more difficult to rethread.

Using a titanium coated or non-stick needle can help prevent thread breaks on these coated materials.

Is the Needle Size Appropriate for the Design?

If your design contains a significant amount of finer detail work, the smaller stitches can result in thread breaks if they are smaller than your needle.

Using a smaller needle like a 70/10 or 65/9 can help with small lettering and fine details.

Is the Backing Appropriate for the Material?

Sewing without proper support can reduce sew quality and increase thread breaks.

Choose a backing that is appropriate to the material and design you are embroidering.

Lighter, stretchy, and flimsy materials may require a more substantial cut-away type of backing. More stable materials can utilize tear-away type backings.

Design size and density may also need to be considered when choosing a backing. Heavier stitch counts in smaller areas will require a more stable backing.

Is the Design Appropriate for the Material?

While the majority of standard garment material will support the majority of embroidery designs, the design / material relationship is one that must be considered.

Consider the difference in embroidering a 10 inch, 50,000 stitch design on a jacket back and then on a t-shirt. The jacket back would have a far better sew quality with that number of stitches in that space. The t-shirt would likely pucker and curl under the embroidery.

Make sure that the material and backing can support the design OR make sure the design settings are appropriate for the material.

If you are embroidering on a lighter material, try using lighter densities and placing fewer stitches on the garment.

Are You Using Adhesives?

Adhesives can certainly gum up the works when it comes to embroidery. These sticky helpers keep appliqué and backing in place, but they can build up on the needles and cause thread breaks.

Avoid using adhesives if possible. If the job requires the use of adhesives, use the minimum amount you can. Using a titanium or non-stick needle can prevent the adhesive buildup and consequent thread breaks.

Is the Garment Hooped Properly?

How a garment is hooped will affect how the material runs in the machine. If hooped poorly, the material may bounce or “flag”. This can create odd thread dynamics and produce thread breaks as well as registration loss and overall poor sew quality.

Sewing with loose hoop arms can create similar results.

Use a hoop that fits as closely to the design as possible. Properly adjust the hoop tension, and insure that the hoop arms are securely attached.

Are You Using Specialty Threads?

Specialty threads often require specific needles and digitizing to sew smoothly.

Consult the manufacturer’s website for specifics on sewing specialty threads.

Troubleshooting Machine Caused Thread Breaks

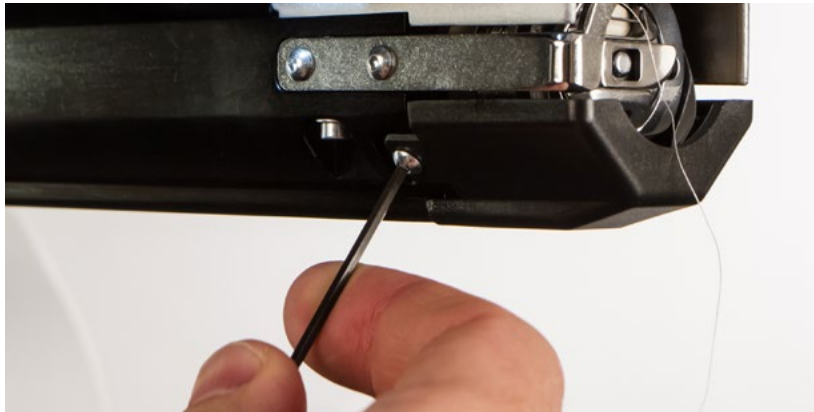
Cleaning Under the Needle Plate

Thread trimmings and lint buildup can cause thread breaks and misstrims. Cleaning beneath and ensuring that the needle plate is centered can prevent these frustrations.

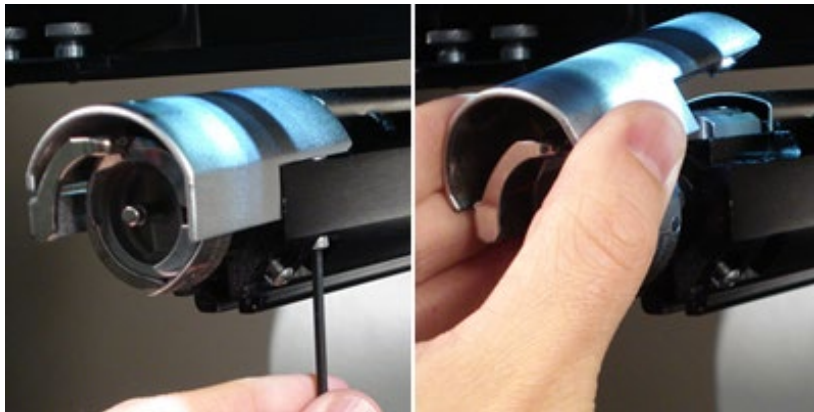
- Cleaning Under the Needle Plate
- Center the Needle Plate

Cleaning Under the Needle Plate

1. Remove the bobbin case.
2. Remove the rotary hook guard by loosening the two button head screws securing it and sliding it away from the machine.



3. Remove the needle plate by removing the two allen screws that secure it.



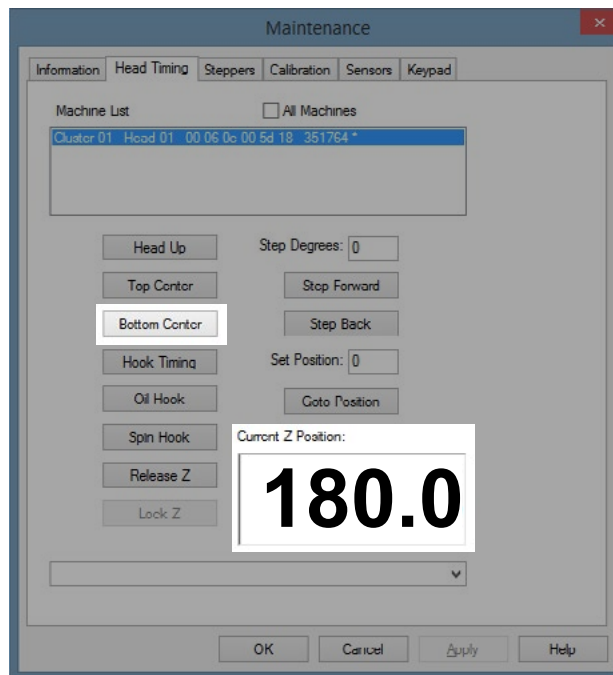
4. Using compressed air or a brush, remove any thread or lint buildup from the area.
5. Reinstall the rotary hook guard.
6. Reinstall the needle plate.

Center the Needle Plate

1. Center the needle plate as best you can by feel and by eye.
2. Lower the needle to its bottom most rotation.
 - This can be done manually by pressing the e-stop and rotating the z-shaft to control the descent of the needle,
 - OR by going to Tools > Maintenance > and the Head Timing tab. Then clicking on Bottom Center.



This will bring the needle down very quickly.



3. With the needle lowered, loosen the screws securing the needle plate, and center the hole in the needle plate around the needle.



4. Tighten the screws securing the needle plate.
5. Depending on the method used to lower the needle, raise it back up by releasing the E-stop or clicking on Head Up and OK.

Pinch Rollers Need Maintenance

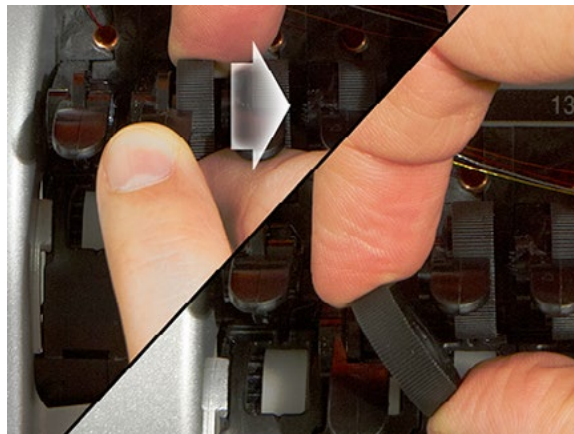
The most common sign that pinch rollers need maintenance is that the thread will walk to the side of the roller and create a “bird’s nest”. This is typically flagged by the software as a thread break, but when you look at the top thread, it doesn’t appear to be broken. However, when you look under the cloth, you find a mass of thread under the needle plate.

Maintaining these rollers is part of the normal maintenance timers, but if you are experiencing trouble with bird-nesting, clean and grease the rollers.

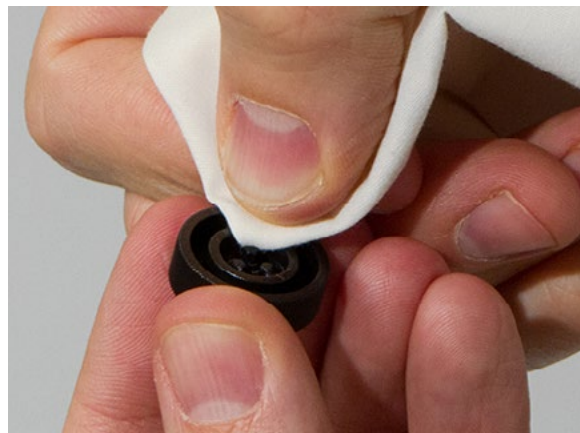
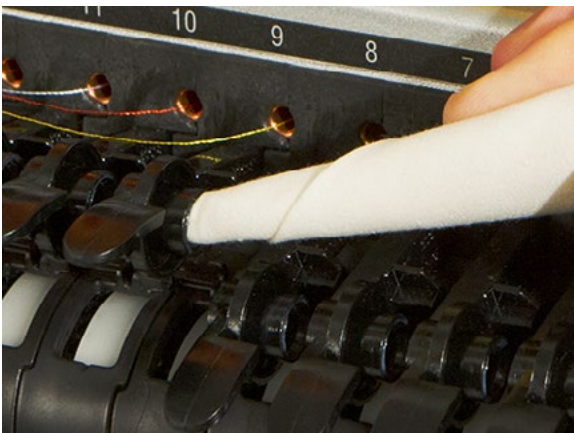
Cleaning & Greasing the Pinch Rollers

To clean and grease the pinch rollers,

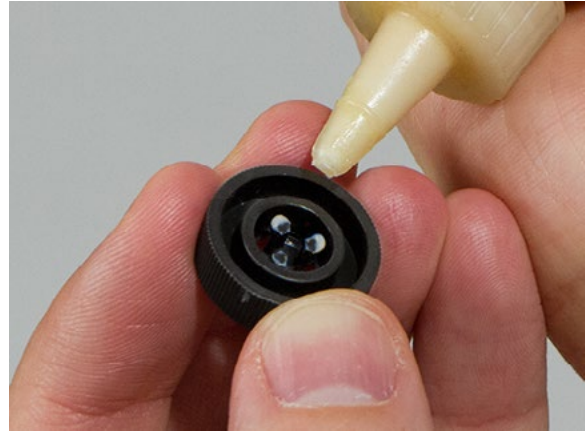
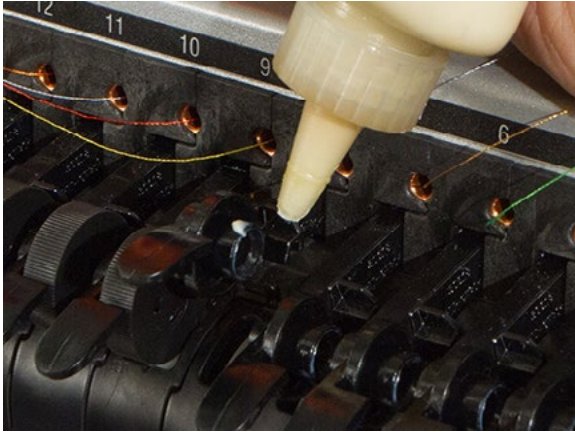
1. Lift the thread feed arm.
2. With one hand, steady the lever. With the other hand, pull the pinch roller to the right and off of the hub.
3. Next, with the roller tilted, pull the arm slightly to the left and pull the roller straight out from the machine. The arm has a small amount of flex to it, but if pulled too far to the left, it can be damaged.



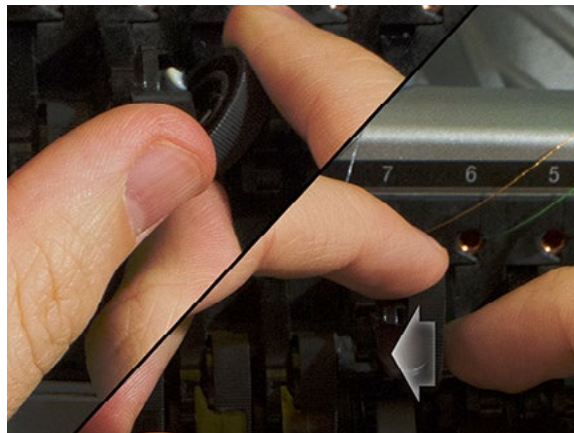
4. With a soft cloth, clean both the hub and the pinch roller. Take care to avoid getting grease on the pinching surface of the roller.



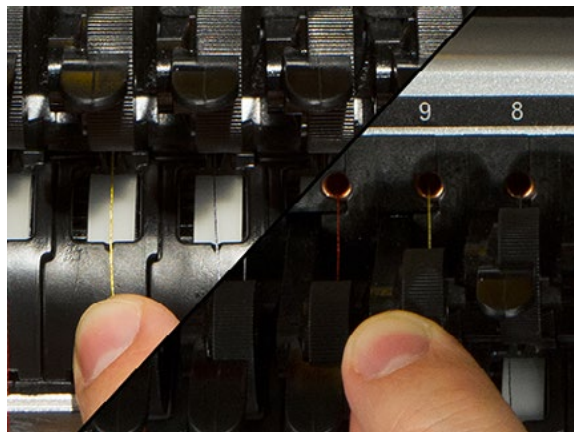
5. Apply EMB Polymer grease to the top surface of the hub and on the outer surface of each of the three tabs inside the pinch roller.



6. With the roller tilted, pull the arm slightly to the left and reinsert the roller straight into place.
7. Tilt the roller back up. Gently rotate the roller to help spread the grease before snapping it into place.



8. Press the roller to the left to snap it into place.
9. Line the thread up with the v-notch on the thread feed gear cover and press the pinch roller arm back down.

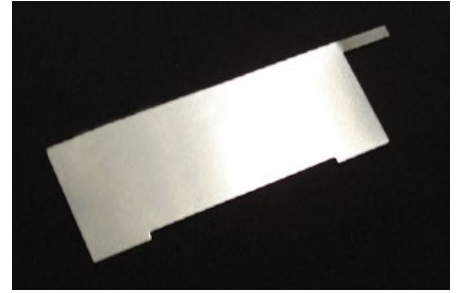


Rotary Hook Support Adjustment

The rotary hook support may need to be adjusted if a garment gets caught in the rotary hook or if it is struck too forcefully with a hoop as the hoop is being loaded onto the machine. It may also need to be adjusted if the screws securing it are accidentally loosened.

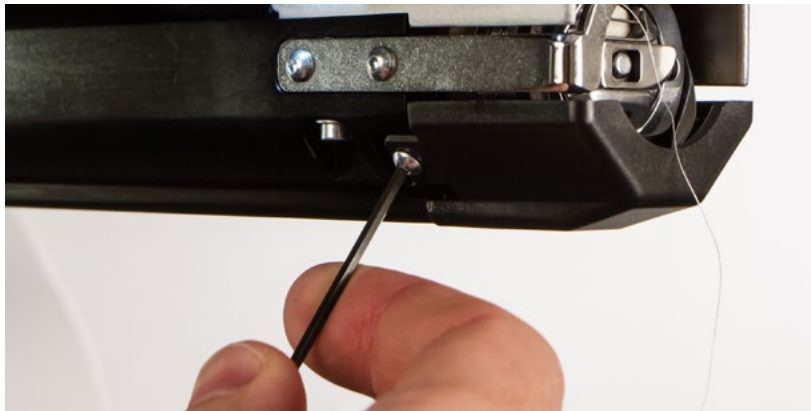
If the rotary hook support gap is too large or too small, it will cause sewing issues.

To inspect and adjust the rotary hook support gap, you will need the Hook Retaining Finger Gauge (PN:009027-01).

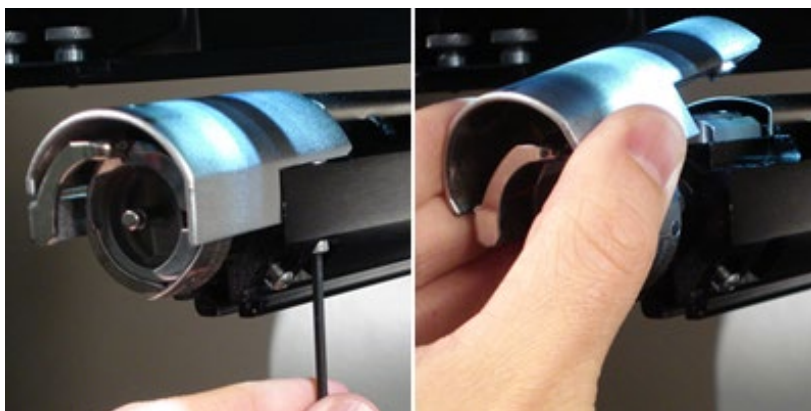


Inspect the Rotary Hook Support Gap

1. Remove the bobbin case.
2. Remove the rotary hook guard by loosening the two button head screws securing it and sliding it away from the machine.



3. Remove the needle plate by removing the two allen screws that secure it.



4. In the software, go to Tools > Maintenance > and the Head Timing tab.
5. Click on Bottom Center.



This will bring the needle down very quickly.

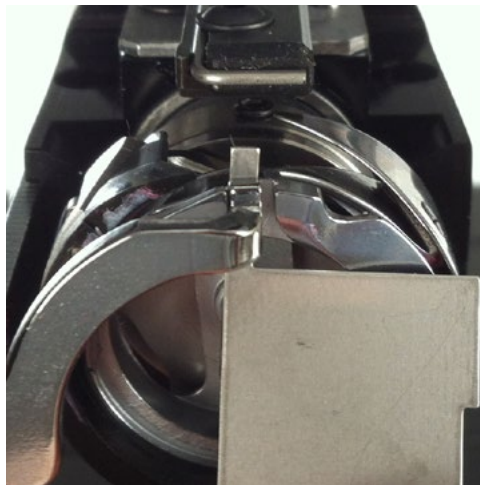
6. Inspect the left to right position of the hook support as it aligns to the needle. It should be center left to right. If not, it may be necessary to form the hook support to the correct alignment. If this is not possible, you may need to replace the hook support (PN: 33046).



7. Once the left to right position of the hook support is correct, click the Head Up button and then click OK.
8. Insert the retaining finger gauge between the hook support and the hook basket.



If the gauge does not slide in easily, do not force it. You may scratch the highly polished surface of the hook support or hook basket, resulting in thread breaks.



The retaining finger gauge should slide between the hook support and the hook basket with no resistance. The gap between the hook support and the hook basket should be no more than 1.1 times the thickness of the gauge. (The gauge is 0.020', and the tolerance is +/- 0.002')

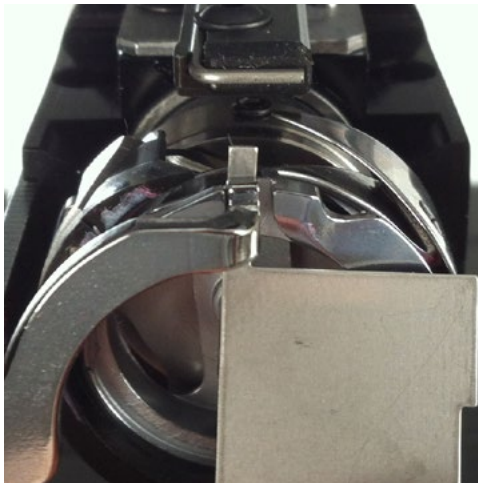
9. The tip of the hook support should be flush with the top of the hook basket.
10. If the adjustment is not correct, adjust the rotary hook support with the procedure below.

Adjusting the Rotary Hook Support

1. Use a hex wrench to loosen the two screws holding the hook support.
2. Insert the gauge between the hook support and the hook basket.



3. Holding the hook support from the side with the adjustment screws, adjust the position of the hook support to the requirements from the inspection procedure above.
4. Remove the gauge while holding the position of the hook support. Make sure that the tip of the hook support is no higher than the hook basket.



5. Tighten the two screws holding the hook support.
6. Verify that the gauge still slides freely between the basket and the hook support.
7. Reinstall the rotary hook guard.
8. Reinstall the needle plate.

Resetting the Machine

Sometimes just getting a fresh start with your machine can help. By deleting a couple of folders on your computer, you can restart your machine and begin anew with factory defaults. It requires the following steps.

- Deleting the Jobs & Machines Folders
- Power Up the Machine With Force Download On

Deleting the Jobs & Machines Folders

By deleting the Jobs and Machines folders on your computer, you will remove any settings associated with the machine from your computer. After removing these folders, the machine can be restarted. To remove these folders,

1. Make sure the machine is powered down and the software is not running.
2. Using Windows Explorer, navigate to
 - for 32 bit systems, C:\Program Files\Melco\Melco OS vXX
 - for 64 bit systems, C:\Program Files (x86)\Melco\Melco OS vXX
3. Delete the "Jobs" and "Machines" folders.

Power Up the Machine With Force Download On

By powering up the machine and utilizing "Force Download", a fresh new set of files will be sent to the machine.

1. Make sure that all of the machines are turned off.
2. Launch Melco OS and wait for the grey screen.
3. Select Tools, then Options. Click on the Ethernet tab. This step is usually only required for the initial power up.
 - a. Ensure that the Ethernet adapter/card that is connected to your machine(s) is selected (left-click to select)
 - b. Turn on Force Download by placing a check in the box.
 - c. Click OK.
4. Make sure the E-Stop is disengaged.
5. Power up the machine with the power switch in the back.
6. The software will load CSA and RSA files.
7. The machine will initialize and display on screen.

Additional Troubleshooting

Miss-Starts

Typically, a miss-start occurs when the machine starts the sewing process without grabbing the bobbin thread. Use the following table if you are experiencing miss-starts.

Possible Causes	Solutions
Tail length (length of thread tail left after a trim) may be set too short	In the software, select Tools>Settings menu, then click the Settings tab. Change the tail length setting to Medium or Long.
Thread is not held in trap (in grabber assembly) during trims b/c the trap or grabber blade may be damaged or may not be adjusted correctly.	Contact Technical Support
Under thread presser (which holds bobbin thread after a trim) may be damaged or not adjusted correctly. The under thread presser is part of the trimmer system and is located directly under the adjustable fixed knife. This is on legacy machines only (XT and XTS)	<p>The under thread presser needs to be inspected (you may find this easier to do if you remove the needle plate). Inspect the under thread presser to determine if it is touching the adjustable fixed knife (you may find this easier to do if you use a flashlight).</p> <p>If the under thread presser is not touching the adjustable fixed knife, it needs to be replaced or adjusted; contact Technical Support</p>

Skipped Stitches

Use the following troubleshooting table if you are encountering skipped stitches in your embroidery.

Problem Area	Possible Causes	Solutions
Needles	Needle is bent or damaged	Replace with a compatible needle
	Incorrect needle for the thread size being used	Replace with a compatible needle
Needle depth	Needle bar lowest dead point is incorrect	Adjust needle depth.
Rotary hook	Hook timing is incorrect	Adjust hook timing
	Hook gap is too wide	Adjust hook timing gap
	Damaged/ bad hook	Replace hook
Presser foot	A weak or broken presser foot spring prevents the presser foot from lifting out of the fabric smoothly	Replace the spring (Contact Technical Support)
	The presser foot height may not be adjusted correctly	Check Presser Foot Height

Problem Area	Possible Causes	Solutions
Thread	Bad thread	Use the appropriate thread

Loose/Looping Stitches

Use the following troubleshooting table if you are encountering loose stitches in your embroidery.

Possible Causes	Solutions
Thread feed is set too high.	Lower the thread feed setting.
Design density too tight.	Use design editing software to decrease density.

Needle Breaks

Use the following troubleshooting table if you are encountering needle breaks.

Possible Causes	Solution
Needle is too small for fabric	Replace with compatible needle
Needle strikes the needle plate	Center the needle plate. Adjust thread feed so that enough thread is used to prevent the thread from pulling the needle away from the hole in the needle plate. Avoid needle deflection by hooping appropriately and using a design digitized to sew away from anchor points in the design or garment.

Registration Issues

Most registration issues are caused by poor hooping or inadequate backing. However, you can perform a registration test to determine if your machine is experiencing problems with registration. See the Technical Manual, Registration Test, for instructions on performing this test. Use the following table to troubleshoot if you determine from the test that your machine is experiencing problems with registration.

Possible Causes	Solution
Hoop arms are not securely attached to the machine	Tighten screws attaching hoop arms
Clips on hoops arms are not securely attached	Tighten screws attaching clips to hoop arms
Improper hooping	See the hooping for instructions on how to hoop correctly
Inadequate lubrication of X rails and/or Y rails	Lubricate X-rails
	Lubricate Y-rails
Incorrect X-cable, Y-axis timing belt and Z drive belt tensioning	Check belt tensioning (Technical Manual)

Test Design Analysis

If you are still experiencing thread breaks after checking all of the areas discussed in the above sections, you may want to perform a more in-depth analysis. This analysis involves sewing out the test design, AMPASS or BRAVOPASS.

In software, click on Load Design or Load Design Wizard and locate AMPASSXXX or BRAVOPASSXXX (where XXX is the latest released version), under C:\Program Files\Melco\Melco OS\Test Designs\AMPASSXXX.exp (or BRAVOPASSXXX.exp). Set the material thickness to 3 points and the maximum sewing speed to 1000-1200 s.p.m.

Sew AMPASS or BRAVOPASS out on a piece of cotton broadcloth hooped with one piece of standard 2.0 oz. cutaway backing material.

From the beginning of the test, if the problems are addressed as described below, their frequency should become much less as you continue the test. (Note: the most challenging is the small lettering; quite often, resolving thread breaks in this area will solve any thread break problems.) As you sew AMPASS or BRAVOPASS, use the following table to troubleshoot problem areas.

If thread breaks occur when sewing:	Check the following items:
Horizontal or vertical bars at startup, or soon after (also called miss-starts).	Hook timing and hook gap Make sure tail length (length of thread tail left after a trim) is adequate Make sure that thread is being held in trap (in grabber assembly) during trims Check the under thread presser spring Inspect thread feeder rollers & pinch rollers for wear and/or damage
At the startup of the small lettering	Hook timing
Small lettering (after startup)	Needle depth Hook timing and hook gap Needle orientation Make sure the needle plate is centered Inspect thread feeder rollers & pinch rollers for wear and/or damage
Triangles & Fill	Hook timing. Hook timing is the most frequent cause of thread breaks in this area Inspect thread feeder rollers & pinch rollers for wear and/or damage
At the startup of the circles	Hook gap

melco

If thread breaks occur when sewing:	Check the following items:
Circles (after startup)	Burrs on needle plate hole Needle orientation Hoop may be hitting needle plate Inspect thread feeder rollers & pinch rollers for wear and/or damage
Diamond	Needle orientation Hook gap Inspect thread feeder rollers & pinch rollers for wear and/or damage
Horse and Buggy	Needle orientation Inspect thread feeder rollers & pinch rollers for wear and/or damage
Spiral and Starburst	Needle orientation

Software Messages

The software reports any messages, whether they are change messages or error messages, in the Machine Bar.

Error Messages

The following is an alphabetized list of software error messages and what to do when you encounter these messages.

If the software ever displays an error message that is not listed here, or if you do not know how to respond to a message that is listed here or in the Technical Manual, contact Technical Support for assistance.

Error Message	Recovery Method
APPLIQUÉ position error – trying to perform a function when X/Y sitting in ‘stop for appliqué position’	Machine is stopped for an appliqué. Finish the appliqué or click the reset design button.
Cutter not home	This message is displayed when the Start button is pressed to begin sewing or a Head Timing Function is performed, but the machine finds the cutting blade is not in its home position. Open the Maintenance menu and select the Steppers tab. Under Cutter, click the Home button.
DSP Command Error	The motor controller received an invalid command sequence; this results in a fatal error and the CPU halts. Call your Technical Support Representative for help.
E-Stop Button Engaged	This message is not necessarily an error message; whenever the E-Stop button is engaged, this message is displayed. If you do not want the E-Stop button to be engaged, turn the button in the direction of the arrows to disengage.
GOTO func error – trying to do GOTO stitch/color when already doing some function, ie:trace,sew	Wait until the machine has completed performing the current function. Then you can perform the Move function.
Grabber not home	The safety grabber is not fully retracted to its home position. Make sure the grabber is not caught. Then Open the Maintenance menu and select the Steppers tab. Under Grabber, click the Home button.
HOOP CENTER error – not allowed when in middle of sewing a design	You have tried to center the hoop while a design is sewing. Wait until the design is completed sewing to center the hoop.

Error Message	Recovery Method
HOOP Limit	<p>If the X beam or Y beam motion is not within the sewing field limits when the machine is running, the machine will stop and the software will give this error.</p> <p>Select a larger hoop in the software.</p>
Missed headup while sewing	<p>The Z axis controller missed a Head Up signal. The machine waits for another 150° of rotation, and if the signal still hasn't been seen, stops sewing.</p> <p>Open the maintenance menu in the software. Select the Head Timing tab and click the Head Up Button. Then press the Start button.</p> <p>If this happens frequently call your service representative for help.</p>
NO design queued – pressing start key with no design selected	<p>Load a design to the machine. Then press the Start button.</p>
No trace Data	<p>Load a design to the machine. Then press the Start button.</p>
Not allowed while sewing – trying to do function while sewing	<p>Wait until the machine has completed sewing.</p>
Not at headup	<p>You are trying to execute a move function or color change function when the sewing head is not at Head Up.</p> <p>Open the maintenance menu in the software. Select the Head Timing tab. Then click the Head Up Button.</p>
Not on a valid needle	<p>The needle case has been manually moved. Push the E-Stop button, then disengage the E-Stop button by turning it in the direction of the arrows a quarter turn and releasing it.</p>
Outside sewing field – trying to TRIM outside of selected hoop sewing field	<p>You are trying to do a Trim Immediate when the needle is outside of the selected hoop limits.</p> <p>Select a larger hoop in the software.</p>
RETURN ORIGIN error – not in middle of a design, function not allowed	<p>You have tried to return to origin when you are not in the middle of a design.</p>
Thread Break	<p>Make sure the thread path is clear, there is bobbin thread, and the needle is installed correctly. Rethread the needle and press the Start key.</p>