

BERNINA

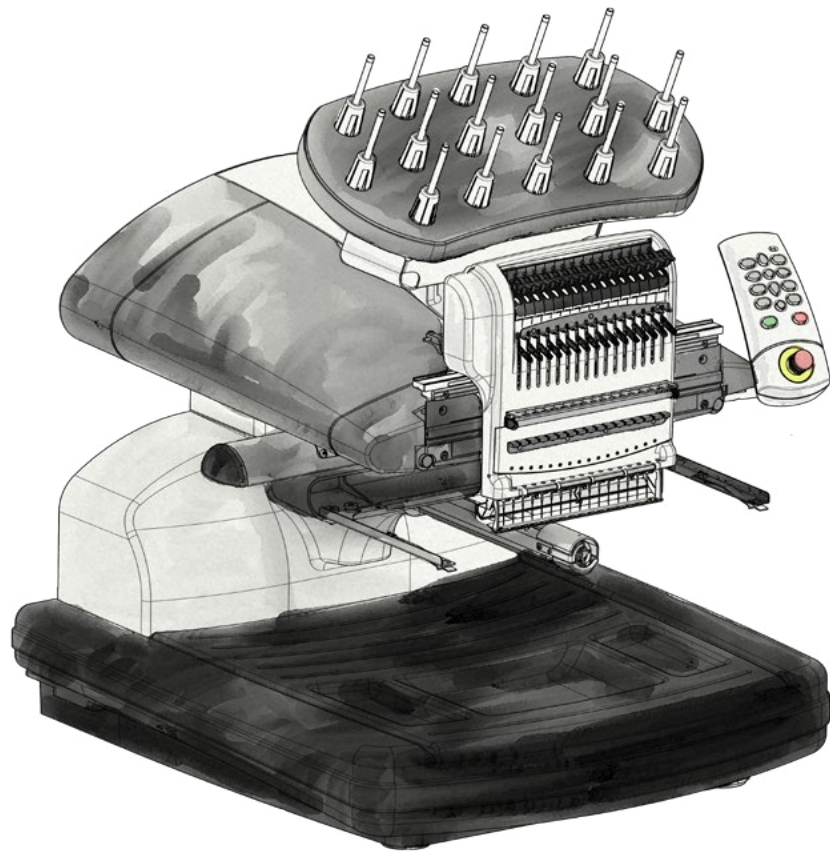

E 16 Technical Manual

Rev 101017

Contents

Copyright Notice	9
About This Manual	10
Scope of Manual	11
Standard Conventions and Definition of Terms	12
Regulatory Notices	13
Best Maintenance Repair Practices	14
Maintenance Philosophy:	14
Grounding and Static Electricity	17
Machine Orientation	19
Safety Issues	20
Warranty Considerations	21
Explanation of Machine Symbols	22
Keypad Operations	23
Keypad Buttons	26
Trace Button	26
Arrow Up Key (Y-Axis Back)	26
Color Change/Needle Case	26
Arrow Left Key (X-Axis Left)	26
Arrow Right Key (X-Axis Left)	27
Center Key	27
Adjustment Key	27
Arrow Down Key (Y-Axis Forward)	27
Hoop Key	28
Step Back Key	28
Step Forward Key	28
Laser Key	28
Start Button	28
Stop Button	29
Emergency Stop Button	29
LED Indicator	30
Specifications	31
Technical Specifications	33
Torque Specifications	34

Software Maintenance Menus	36
Special Tools and Fixtures	37
General Maintenance	38
Cleaning	38
Lubrication Schedule and Specifications	40
Maintenance Schedule	40
Daily Maintenance	42
Weekly Maintenance	43
Monthly Maintenance	45
Quarterly Maintenance	51
Thread Cutter Blade Replacement	61
Centering The Needle Plate	62
Mechanical Head-Up Position	63
Adjusting Head-Up (Z-Home) Position:	64
Hook Timing Inspection/Adjustment	65
Rotational Hook Timing Inspection Procedure	65
Needle To Hook Gap Inspection Procedure	67
Adjustment Procedure	67
Thread Clamp Replacement	71
Thread Clamp PCB Replacement	72
Thread Clamp Harness Replacement	72
Laser Light - Adjustment	74
Needle Depth	76
Setting the Needle Depth by Eye	76
Presser Foot Height	77
X/Y Home Adjustment	78
Home Adjustment Procedures:	78
X-Cable Tension	81
Determining if an X-Cable is Set to Required Specifications	81
Adjusting an X-Cable that is Tensioned Outside the Required Specifications	82
Y-Axis Timing Belt Tensioning	84
Y-Axis Belt Tension Inspection	84
Y-Axis Belt Tension Adjustment	85
When Belt Tensions are Correct	85
Y-Motor Timing Belt Tensioning	86
Inspection and Adjustment	86
Z-TIMING: Bottom Center & Head-Up	87
Bottom Center (Z Timing)	87

BERNINA

Z-Drive Belt Tensioning	92
Inspection and Adjustment	92
Z-Home Adjustment	94
Procedure to Identify the Closest Needle	95
Needle Case Calibration	98
Fine calibration procedure:	98
Rough Calibration Process:	99
Rotary Hook Support Adjustment	101
Inspection Procedure	101
Adjustment Procedure	103
Color Change, Take-Up, Feeder Housing Assembly	105
Replacement Procedure for Entire Color Change/Take-Up/Feeder Assembly:	105
Color Change Linear Actuator Replacement	107
Replacement Procedures:	107
Thread Feeder Gear Replacement	110
Replacement Procedures:	110
Thread Feeder Optical Sensor PCB Replacement	112
Replacement Procedure:	112
Thread Feeder Radial Bearing Replacement	113
Replacement Procedures:	113
Thread Feeder Stepper Motor Assembly	114
Replacement Procedure:	114
Laser Pointer Assembly	116
Replacing the laser assembly:	116
LED Cluster PCB Replacement	118
Presser Foot Assembly Replacement	119
Reciprocator	122
Replacement Procedure	122
Take-Up Lever Cam Replacement	124
Replacement Procedure	124
Z-Drive Repair and Adjustment	127
Z-Drive Belt Replacement and Tensioning	127
Z-Home Sensor PCB Replacement	129
Z-Belt Idler Assembly Replacement	131
Z-Motor Assembly	132

BERNINA

Clearing Thread from Thread Feeder Roller	135
Color Change Spindle Mounting Bracket Replacement	137
Grabber Blade Replacement	139
Needle Case Removal	142
Needlecase Installation	144
Grabber Stepper Motor Replacement	146
Take Up Lever Replacement	147
Thread Feeder (replacement and adjustment)	149
Thread Sensor Assembly Replacement	152
Bobbin Shaft Overhaul	154
Rotary Hook Replacement	156
Main PCB	158
Power Input Assembly Replacement	160
Power Input Assembly Removal:	160
Power Input Assembly Component Replacement:	161
Power Input Assembly Installation:	166
User Interface Assembly Replacement	167
Harnesses	170
Color Change Motor Harness	171
Ethernet Harness	174
Grabber/Threadfeed Motor Harness	176
Grabber/Threadfeed/CC Home Harness	179
Laser Harness	182
LED Cluster Harness	184
Replacement Procedures:	184
Thread Break Harness	188
Z Home Harness	191
User Interface Harness	193
X/Y Home Harness	195

BERNINA

Bearing Block Assemblies	197
X-Beam Assembly	199
X-Carriage Assembly	201
X-Drive Cable Removal	203
X-Drive Cable Installation	205
X-Drive Motor Replacement	209
X-Home Optical Switch Assembly Replacement	212
X/Y Home PCB Replacement	214
Y-Drive Belt Replacement	216
Y-Motor Assembly	218
Troubleshooting	220
Grabber Function Test	221
Final Functional Tests	223
Optical Sensors Test	225
Power Supply Test	226
Servo Motor Resistance Test	228
Stepper Motor Resistance Test	229
Servo Motor Resistance Test	230
Test Designs	231
Thread Tension Test	232
Belt Tension Test	232
Long Stitch Test	233
Looping Test	233
Orientation Test	234
Registration Test	234
Small Alphabet Test	234
Thread Break Sensor Test	235
Thread Break Test	235
Trimmer Test	236
Electrical Failures	237
Color Change Failures	237
LED Cluster Assembly Failures	238

BERNINA

Mechanical Failures	239
False Thread Breaks	239
Loose/Looping Stitches	239
Needle Breaks	239
Skipped Stitches	240
Thread Breaks	241
Miss-Starts	245
Cap Frame Issues	245
Miscellaneous Problems	246
X-Axis Failures	247
Y-Axis Failures	248
Z-Axis Failures	249
Software Error Messages	250
DSP Command Errors	251
Can't Initialize Stepper Motors	251
No Trace Data	251
XY Home Not Set	251
Goto Func Error	252
Hoop Center Error	252
Stepper Motor Time Out and Index Errors	252
E-Stop Engaged	253
Servo Motor Errors (Move Time Out, Tracking, and Over Current Errors)	255
Critical Measurements	257
Introduction	257
Needle Drive Stud to Reciprocator Fit	258
Hook Timing	258
Upper Arm to Lower Bed Alignment	258
Needle to Hook Gap	259
Hook to Rotary Support Gap	259
Take-Up Lever Stroke	259
Take-Up Lever Fit to Shaft	260
Take-Up Lever Endplay	260
Cam Follower Preload	260
Pull Force on Take-Up Lever	261
Color Change Lead Screw	261
Color Change Housing Location	262
Bobbin Tension	262
Presser Foot Adjustment at Bottom Dead Center	263
Thread Feed Forward 200	264
Needles	264
Thread Clean Thread Path	265
Z-Belt Tension	265
X-Cable Tension	266
Y-Axis Timing Belt Tension	266
Proper Lubrication of Moving Parts	266

BERNINA

Copyright Notice

© Copyright BERNINA, 2017

ALL RIGHTS RESERVED. No part of this publication may be reproduced, stored in a retrieval system, or transmitted in any form or by any means (electronic, mechanical, photocopying, recording or otherwise) without prior written approval from the author. The author reserves the right to revise this publication and to make changes in it at any time without obligation of the author to notify any person or organization of such revisions or changes.

All precautions have been taken to avoid errors or misrepresentations of facts, equipment, or products. However, the manufacturer does not assume any liability to any party for loss or damage caused by errors or omissions.

The machine technology is protected by - but not limited to - the following patents:

- Pat. US 6,445,970 B1
- Pat. US 6,736,077 B2
- Pat. US 6,732,668 B2
- Pat. US 6,823,807
- Pat. US 6,871,905
- Pat. US 6,983,182 B2
- Pat. US 7,513,202
- Pat. US 7,308,333 B2
- Pat. US D474,785 S
- Pat. CH 693569 A5
- Pat. US 8,851,001 B2
- Other patents pending

About This Manual

This manual contains instructions on repairs and adjustments to the embroidery machine, in addition to other technical information.

If you do not fully understand any information in this manual, you are advised to contact your local authorized technical support provider for assistance.

Scope of Manual

This technical manual is a guide to performing repairs and adjustments that go beyond routine operator maintenance.

Although these procedures are best understood and performed by professional service technicians in conjunction with specific factory technical training, much of the information in this manual is a useful reference for others who might possess appropriate technical aptitude and skills.

 *Note: This manual is written for individuals with adequate knowledge, Melco certified training or equivalent and experience in the use of tools required. No attempt is made to explain how to use tools required to make repairs to the machine other than graphical depictions within the procedures involved.*

This technical manual specifies that certain functions are to be performed only by authorized service technicians. This is because specialized training and/or special tools or fixtures are required in order to perform the function correctly. Performing repairs to the machine may result in damaged components, poor machine performance, and potential injury to the technician or operator.

If you do not fully understand any information in this manual, contact technical support for assistance before performing the procedure. The technical support staff are professional service technicians trained on this equipment. They have acquired technical expertise through experience and technical training. Additionally, certified equipment technicians routinely receive up to date servicing information to further enhance their product knowledge.

This technical manual is presented in six sections:

1. Introduction to the manual and various service requirements
2. General information and specifications containing all of the engineering settings and specifications you need to know when adjusting the machine
3. Lubrication schedules and procedures
4. Service and repair - detailed instructions to service and repair the machine
5. Options - maintenance and repair of optional equipment
6. Troubleshooting - a troubleshooting guide for problems commonly encountered with the machine.

Standard Conventions and Definition of Terms

Throughout this manual abbreviations and specific terms may be used. When abbreviations or technical terms are used, they are defined through the use of pop-up hot spots, which opens a dialog box to explain their meaning. Hot spot text is green and underlined. To access a pop-up hot spot simply click the underlined word to read its explanation.

Certain procedures in the manual require actions such as pressing a certain key, or typing some letters on the computer keyboard. The following is a list of some of the more commonly used conventions found in this manual:

- To indicate a key on the computer keyboard, the key in question is enclosed in brackets, for example: Press the [Enter] key to initiate the application.
- A key on the interface keyboard is represented by a picture of that key.

Attention Styles:

Occasionally in the manual, special attention is required. In these situations, certain images and text styles are used to attract your attention to a particular message. The following styles are used to denote certain types of messages.



WARNING!! *Situations which may result in personal injury if not performed correctly.*



CAUTION!! *Situations that might result in damage to equipment or property but is not likely to result in personal injury.*



IMPORTANT: *Situations critical to correct machine operation that is not likely to result in damage to the machine or personal injury.*



NOTE: *Important information that is significant, but not likely to result in interference to correct machine operation.*



TIP: *Helpful information that might make a procedure easier or more efficient.*

When a reference to a part description is in bold type, that reference is the actual part description as listed in the machine parts manual. The parts manuals are unique for each machine depending on serial number and date of build. For part numbers, pictures, and assembly diagrams, refer to the parts manual issued for that particular machine.

Regulatory Notices

(U.S.) The FCC (Federal Communications Commission) mandates that if a user makes changes or modifications to the machine not expressly approved by the manufacturer, the user's authority to operate the machine may be voided.

BERNINA

Best Maintenance Repair Practices

The procedures presented in this manual are to be considered best maintenance repair practices. These procedures are intended to optimize the performance and durability of your machine. Best maintenance repair practices are to be performed using the correct tools and fixtures while adhering to all safety precautions appropriate for each job.



WARNING!! *Personal injury may result if proper precautions are not observed. Remove rings, watches, and any other metallic objects from hands and wrists before servicing the machine. Remove metallic articles from shirt pockets to prevent them from falling into the machine. Do not allow loose clothing or long hair contact moving parts of the machine. Under certain conditions of machine failure, the moving parts of the machine may not be controllable by normal means. At these times, the machine may operate without notice.*



CAUTION!! *Use extreme care not to drop metallic objects, tools, or other conductive material on the main Printed Circuit Board (PCB) when you have the base cover removed. If you drop such objects on the main PCB, it can severely damage the electronics which will be very expensive to repair.*

Maintenance Philosophy:

The maintenance philosophy used in this manual is to isolate potential problems within the system to the smallest practical replacement assembly. Therefore, components are typically not repaired, but rather, a circuit board or mechanical subassembly may be replaced.

In the process of isolating problems in the machine, the person performing the troubleshooting must also practice good troubleshooting techniques. Good troubleshooting techniques include, but are not limited to, guarding against static electricity that can result in further damage to machine components, and only replacing one part at a time to enable identification of the defective part after the machine is repaired.



WARNING!! *Failure to practice Best Maintenance Repair Practices may result in injury to personnel performing the work and/or damage to the equipment. The warranty is exclusive of, and may be VOID if poor maintenance practices have caused damage to the equipment.*

Dust:

As with any electronics, the worst source for contamination for the PCBs and the Control PCB is dust. Although great care has been made during the design of the electronics in the machine, dust accumulation may cause failure of the machine if it is allowed to accumulate.



CAUTION!! *DO NOT use solvents of any type on the printed circuit boards (PCBs) or sensors. Solvents will damage the electronic components. Use only compressed air to clean these items.*

BERNINA

Using compressed air, blow the dust away from sensors and off the PCB's in the machine. In addition, minimize dust accumulation cleaned on all exposed surfaces. Excessive dust will reduce the useful life span of the machine.

Sensors should be cleaned with dry, compressed air during each of the lubrication cycles. Dust accumulation in the base around the control PCB should be blown out every month or whenever the base cover is removed for any type of maintenance.

Liquid Cleaning Compounds:

Never spray liquid cleaning compounds directly onto the machine, especially if it is turned on or connected to an electrical supply outlet. Always spray cleaning compounds onto a rag and wipe the machine clean. Liquid cleaners can, if sprayed directly on the machine, get onto electrical components and short them out. Optical sensors are very sensitive and may be damaged by liquid cleaning compounds.

Obstructions:

Obstructions of machine movements can cause severe damage. Obstructions include things like fabric getting caught in the gears, loose hardware left inside the machine, thread accumulation around the grabber blade, Velcro, and anything that hinders the machine's moving parts. It is very important to clear obstructions from any subsystem immediately before damage or excessive wear occurs.

Use Proper Parts For The Job

It is very important that you use the proper parts for the job, especially needles. Refer to the Operator Manual for information on needle selection. Using the wrong needle will increase the frequency of frays and thread breaks and will decrease performance of the machine.

Avoid using substandard substitute parts on the machine. Always use manufacturer distributed parts or better to ensure superior quality output of your machine. When considering buying substitute parts, i.e., hardware, it is strongly recommended that you consult Technical Support and obtain the specifications to ensure that you get the equivalent grade or better parts.

Use The Correct Tools When Making Repairs

Always use the correct tools when making repairs or performing maintenance on the machine. No attempt has been made in this Manual to explain what tools to use. It is assumed that the person who makes repairs or performs maintenance on the machine has the proper technical aptitude and training to allow them to do so. Using tools incorrectly or using the wrong tools can cause damage to the machine and result in personal injury.

The use of poor quality tools such as multimeters and mechanical measuring devices can produce unpredictable and often unsatisfactory results. Always purchase tools for repair or maintenance on the machine that are of standard design and professional quality. You may if desired, consult Technical Support for assistance in recommending such tools as multimeters and measuring devices before you purchase them.

Drive Belt Tensions:



CAUTION! Damage to the machine may result if belt tensions are improperly adjusted. All drive belts require special procedures and tools for setting the proper tensions. If the tension adjustments are made without using the proper procedures and tools (and without training in some cases), poor performance, excessive wear, damaged components, personal injury, and voided warranty may result.

Scheduled Maintenance:

Scheduled maintenance is lubrication, cleaning, measurements, and inspections that are specified on a periodic schedule.

Scheduled maintenance is prescribed in the operator manual for the machine. Failure to perform scheduled maintenance will result in poor performance and eventual failure of the machine. In addition, failure to perform the maintenance prescribed in the operator manual can affect warranty protections.

Lubrication:

Lubrication should be done whenever a part is replaced or repaired and as prescribed according to the Lubrication Specifications. When applying lubricants to any parts, use only the approved lubricants and application methods specified in the Lubrication Specifications.



CAUTION! Damage to the machine will result if inadequate or excessive lubrication is applied to machine parts. Failure to adhere to lubrication specifications will result in premature wear, poor performance, and potential warranty issues.

Torque Measurements:

Apply proper torque to all screws, bolts, and nuts or similar parts used in the machine. Torque specifications are provided for a reason. They have been developed from years of experience with the parts involved. Avoid guessing at the torque applied to a part and measure it, especially where measurement is specified.



CAUTION!! Inadequate torque can result in premature failure of the part involved, usually causing it to come loose. Excessive torque usually results in stress to the part that will not always be detectable. The part can fail later during machine operation and can cause catastrophic machine failure.

Grounding and Static Electricity



WARNING!! *It is very important that the power cord is plugged into a properly wired electrical outlet. Failure to have a properly wired outlet may result in damage to the equipment and personal injury. It is recommended that a licensed electrician be consulted to ensure that the electrical outlet is properly wired and grounded. If a properly wired electrical outlet is not used for the source supply voltage to the system, electrical failures may result.*

Static Electricity:

As with all computerized equipment, your machine is sensitive to static electricity. Any time work is performed inside covered areas of the embroidery machine, the person performing the work must use a static grounding strap or take adequate steps to dissipate static build-up prior to touching electronic components.



WARNING!! *Failure to use a grounding strap, or failure to practice other good maintenance/repair techniques may cause damage to the machine and possible personal injury.*



CAUTION!! *Unless otherwise specified within these procedures, DO NOT disconnect the electrical supply input cord from the machine or the electrical input source outlet. Doing so will remove the ground connection needed to dissipate the electrical static build-up prior to working on the internal components in the machine. Always make contact with the exterior metal portion of the machine for about one minute to dissipate any electrical static build-up in your body before touching any electronic component of the machine, especially the main board.*

Grounding Strap Use:

A grounding strap should be connected properly to ensure that static charge on the person's body is neutralized to the chassis ground of the embroidery machine when working in the electronic areas under the covers. Proper connection is provided at any bare (unpainted) metal surface or any other surface (such as a ground screw head) that is known to be an earth ground. If a ground strap is not used or is not available, touch the chassis for about a minute to dissipate any static build-up before you touch any electronic component inside the machine (with the machine turned off and the power input cord connected to an electrical outlet).



WARNING!! *DO NOT attempt to use any grounding strap that is not specifically designed for static use. A "straight-wire" grounding device (one without built-in resistance) will place the operator in danger of exposure to dangerous voltages. It is recommended that the static strap be checked during daily use for proper resistance protection.*

BERNINA



CAUTION !! Use extreme care not to damage the cable and protective coating during assembly. If the protective coating is damaged, the cable will wear out very fast impacting the quality of the sew outs.

BERNINA

Machine Orientation

The references in the manual to certain sections of the machine are oriented as if you were facing the front of the machine as shown below. Example: The “left” arm cover is on the left side of the machine when you face it from the front, but is on the right side if you face it from the rear. The part however, is called the “left” arm cover since it is installed on the left side, oriented as you face the machine from the front.



The left and right sides of the machine are oriented just as if you were facing it from the front side of the machine directly.

The rear of the machine refers to the entire back side of the machine.

The front part of the machine refers to the entire front section of the machine.

The upper arm assembly, lower arm assembly, needlecase, user interface, and thread tree refer to the entire individual assembly and associated components.

Safety Issues

Voltages



WARNING!! Lethal voltages exist inside the power supply unit, at the back side of the electrical supply input connector, and in the wires between the two. If you plan to do any work with any of these components, turn the power switch off and disconnect the electrical input supply cord from the machine.



WARNING!! DO NOT disassemble the power supply unit. It contains no customer or field serviceable parts. The internal components in the power supply unit may contain dangerous voltages even when the power is disconnected. Disassembling the power supply can cause severe injury resulting from electrical shock, and may void the warranty.



WARNING!! DO NOT operate the machine with the lower rear cover removed, except when indicated by the instructions in this manual. Operating the machine without the covers creates a risk of severe electrical related injury.

Hazardous Material Notices:



WARNING!! The lubricants specified in this Manual contain known carcinogens. Do not allow lubricants to come into contact with your eyes, mouth, or nose. Always wash your hands thoroughly after performing lubrication procedures.



WARNING!! When using solvents to clean components in the machine, always ensure adequate ventilation. Allow all solvents to completely evaporate before turning the machine back on to prevent shorting out electrical components. Vapors from most solvents are both toxic and flammable. Dispose of rags soaked with solvent properly.

Moving Parts:



WARNING!! Do not operate the machine without the covers being installed. Moving parts can cause crushing and pinching injuries. In addition, fabric and other materials can get caught in the moving belts and gears and damage the machine.



WARNING!! Do not attempt to pull on or trim threads near moving needles. This can result in painful injury.

Warranty Considerations

Many areas of maintenance in this manual require factory trained personnel to ensure proper service. Any service that is improperly performed may void the warranty.

Items that are marked "...should be done by an authorized service technician" should be performed by a repair technician that has been authorized by the manufacturer. Performance of these items requires special training and/or tools and involves a great deal of difficulty. If technician only items are repaired/installed incorrectly, it will void all applicable warranty considerations and can cause further damage to the machine.

The use of other than manufacturer issued or recommended parts, hardware and lubricants can affect warranty considerations. It is strongly recommended that you use only products from the manufacturer or products recommended by technical support on your embroidery machine(s).

Explanation of Machine Symbols

These labels are placed on the machine at specified locations to warn you of certain machine hazards.



Caution!!



Indicates a machine component will move. Keep clear!



Shock Hazard. No user replaceable parts behind this label. Do not open!



Moving gears. Keep clear!



Vertical Pinch Point. Keep clear!



Horizontal Pinch point. Keep clear!



Needle Pinch point. Keep clear!



























BERNINA

Keypad Operations

















Function	Press these key(s)	Keypad Pictures	Notes
To Start Sewing	Start		Press the stop key to stop sewing
To Stop Sewing	Stop		Press the start key to start sewing
Cuts power to the motors.	Emergency Stop E-Stop		To release, turn a quarter turn in the direction of the arrows and release.
Select Machine	Center		Selects the machine to be displayed in the software
To move the hoop up	Hoop + Down Arrow		Always trace after moving
To move the hoop down	Hoop + Up Arrow		Always trace after moving
To move the hoop left	Hoop + Right Arrow		Always trace after moving
To move the hoop right	Hoop + Left Arrow		Always trace after moving

BERNINA

Function	Press these key(s)	Keypad Pictures	Notes
To move the hoop down and to the left (moves needle position up and to the right in relation to the hoop)	Hoop + Right + Up	 +  + 	Always trace after moving
To move the hoop up and to the left (moves needle position down and to the right in relation to the hoop)	Hoop + Right + Down	 +  + 	Always trace after moving
To move the hoop down and to the right (moves needle position up and to the left in relation to the hoop)	Hoop + Left + Up	 +  + 	Always trace after moving
To move the hoop up and to the right (moves needle position down and to the left in relation to the hoop)	Hoop + Left + Down	 +  + 	Always trace after moving
To center the current hoop	Hoop + Center	 + 	Center hoop before beginning to sew
Clears and ignores the "Trim Required" message.	Hoop + Adjustment	 + 	This indicates to the machine that no thread is through the cloth.
To trace the design	Hoop + Trace	 + 	Repeat to trace again
To frame back one stitch at a time	Hold down the Frame Back key		Press the stop key to stop framing
To frame forward one stitch at a time	Hold down the Frame Forward key		Press the stop key to stop framing
To increase the sewing speed	Adjustment + Up Arrow	 + 	The speed will increase 50 spm each time pressed
To decrease the sewing speed	Adjustment + Down Arrow	 + 	The speed will decrease 50 spm each time pressed
To move the needlecase to the right	Needlecase key + Right Arrow	 + 	

BERNINA

Function	Press these key(s)	Keypad Pictures	Notes
To move the needlecase to the left	Needlecase key + Left Arrow	 + 	
To color change to the next color	Needlecase key + Up Arrow	 + 	
To color change to the previous color	Needlecase key + Down Arrow	 + 	
To turn the laser on	Laser		This will allow you to see the active needle position
Toggle front grabber	Adjustment + Center	 + 	Toggle to thread the needle
Trim Immediate	Adjustment + Needlecase	 + 	
To manually feed thread	Laser + Up Arrow	 + 	Manually feeds thread on the current needle
Go to previous position	Left Arrow + Right Arrow	 + 	

Keypad Buttons

Trace Button



The trace button is used to trace the design, a method used to help the operator determine if the design is properly centered and fits within the hoop used.

+ To trace a design, press the Hoop button and the Trace button.

Arrow Up Key (Y-Axis Back)



+ The needle case moves to the next color.

+ The hoop key and the arrow up key performs a manual jog, moving the stitch point to the top of the design. The hoop actually moves towards the front of the machine.

+ The sew speed (stitches per minute) is increased.

Color Change/Needle Case



When used in conjunction with the arrow keys, the machine will perform a color change function (moving the hoop) or move needle case left or right.

+ Needle case to the left

+ Needle case to the right

+ Color change to next color

+ Color change to the previous color

Arrow Left Key (X-Axis Left)





+ The machine performs a "manual jog", moving stitch point left. The hoop actually moves to the right.

+ The needlecase moves to the left.

BERNINA

Arrow Right Key (X-Axis Left)





 +  The machine performs a “manual jog”, moving stitch point right. The hoop actually moves to the left.

 +  The needle case moves to the right.

Center Key



 +  When used with the hoop key, the machine moves to hoop center.

 +  When used with the adjustment key, the machine toggles the safety grabber in and out. This is helpful in tucking threads back into the trap behind the needles for moving the grabber out of the way for changing of threading a needle.

 Pressing the Center key will select the machine to be displayed in the software.



Adjustment Key



The adjustment key is used to adjust the thread feed or the machine speed.

 +  Adjustment key and the Arrow Up key increase the sew speed (stitches per minute).



 +  Adjustment and Arrow Down key decrease the sew speed (stitches per minute)

 +  Adjustment and the Center key toggles the safety grabber in and out (for needle threading access)

Arrow Down Key (Y-Axis Forward)



 +  The Arrow Down key the Needle Case key moves to the previous color.



 +  The Arrow Down key with the Hoop key performs a manual jog, moving the stitch point towards the bottom of the design. The hoop actually moves towards the back of the machine.



 +  The Arrow Down key with the Adjustment key decreases the sew speed of the machine.



Hoop Key





The Hoop key is used to move the position of the needle in relation to the hoop.

 +  The Hoop Key and the Arrow Up key move the needle position up, towards the top of the hoop (moves the hoop forward, toward the front of the machine).

 +  The Hoop Key and the Arrow Down key move the needle position down, towards the bottom of the hoop (moves the hoop towards the back of the machine).

 +  The Hoop Key and the Arrow Left key moves the needle position to the left (moves the hoop to the right)

 +  The Hoop Key and the Arrow Right key moves the needle position to the right (moves the hoop to the left)

 +  The Hoop Key and the Center key moves the hoop to hoop center position

Step Back Key



 The step back key moves the machine backwards on the design (to a lower numbered stitch point). This allows the operator to restitch a certain portion of a design if needed.

Step Forward Key

 The step forward key moves the stitch point in the design forward (to a higher numbered stitch position).

Laser Key

 Press and hold the laser key to turn the laser on. The laser stays on as long as the key is pressed.

 +  You can also press and hold the laser key , then press the up arrow to manually feed thread on the current needle. This function is useful when threading a needle because it can be used to supply more thread (replacing the need to lift the pinch roller and pull out more thread).

Start Button



Pressing the start button while the machine is not running and is at the start of a design will start the sewing of the design.

BERNINA

Pressing the start button while the machine is stopped will re-start the machine at the stitch number where the machine was stopped.

Stop Button



The stop button stops the machine operation but does not disconnect electrical supply to the motors and electronics.



Do not confuse this button with the Emergency Stop button. The machine can still start if there is a machine fault somewhere. The stop button does not disconnect power from the motors or internal components.

Emergency Stop Button



The emergency stop button breaks the electrical circuit to all of the motors to prevent its operation.

BERNINA

LED Indicator

The Status Indicator LED is illuminated when the machine is turned ON.

The LED color and whether it is blinking indicates the machine status or if it has a fault.

Status Light Condition	Definition	Action to Take
Green (blinking)	Machine is on, but no RSA files loaded yet	Start software, check connections
Green (continuous)	Machine is on and ready for operation	
Red (blinking slow)	Indicates a thread break	Re-thread the needle with thread break
Red (blinking fast)	Indicates the machine has run out of bobbin thread	Replace the bobbin
Red (continuous)	Indicates the machine is in E-Stop engaged mode	Release the red emergency stop button

BERNINA

Specifications

For indoor use only

Type/# of Heads	Upper Arm-Lower Arm/1 to 6 Modular
# Needles	16
Maximum Tubular Frame Size (XxY)	500mm x 430mm (19.7" x 16.9")
Maximum Sew Field/Tubular Frame (XxY)	410mm x 350mm (16.1" x 13.7")
WA Cap Frame	362mm x 82mm (14.1" x 3.25")
Conventional Cap Frame	152mm x 70mm (5.9" x 2.75")
Min/Max Sew Speed Flats	300-1400 spm
Min/Max Sew Speed Caps	300-1200 spm
Stitch Length Range	Only Limited by Hoop Size
User Interface	BERNINA E16 OS/BERNINA User Interface
Machine Configuration	Up to 6 individual machines, connected by Ethernet
Self-Diagnostics Capability	Retrieves relevant machine data for troubleshooting
Simplified User Interface	Step by Step Guide Software
Design Memory	Limited only by hard drive, Max file size 500k
Pre-Sew Trace	Laser
Needle to Garment, Garment to Hoop Position	Laser Positioning System
Thread Feed Technology	Patented Acti-Feed
Thread Break Detection	Upper & Lower Electronic Force Gauge Sensor
Automatic Stitch Backup	Yes
Automatic Trimmer	Yes
Lighting Type Cold Bright	Cold bright LED
Power Supply (V)	90-260V (Single Phase, 50/60 HZ, 4A), Class I (Grounded)
Power Consumption (W)	Typical: 200 Watts Max: 650 Watts
Temperature Range	15-40° C
Humidity	Max 85% Relative Humidity
Installation Category (overvoltage)	II
Pollution Degree	2
Motor Type(s)	Servo, Stepping
Motor Capacity (kV)	X and Z: 100 Watts Y: 250 Watts
Machine Construction Material	Aluminum
Physical Specifications with Cart	
Width	724mm (28.5")

BERNINA

Height	1541mm (60.7")
Depth	944mm (37.2")
Weight	95.4kg (210.3 lbs)
Physical Specifications without Cart	
Width	724mm (28.5")
Height	907mm (35.7")
Depth	737mm (29.0")
Weight	75kg (165lbs)

BERNINA

Technical Specifications

The following is a list of various tension and force specifications for your machine. See the Critical Measurements section for other machine specifications that are not listed below.

Specification	BRECO Meter Measurement	Force Gauge Measurement
X Drive Cable Tension	145 ± 5 Hz at 350±2.5 mm between center of first and rear pulleys measured from right side of machine only.	10.5 ± 0.5 lbs [4.76 ± 0.23 kg] using X-Cable Tensioning Procedure
Left and Right Y-Drive Belt Tensions	45-50 Hz with beam to the back at a dead stop	8.1 ± 0.3 lbs [3.67 ± 0.14 kg] using Y-Axis Timing Belt Tensioning procedure
Y-Motor Belt Tensioning	100-120 Hz	7.5 - 9.5 lbs [3.4 - 4.3 kg] using Y-Motor Timing Belt Tensioning procedure
Z-Motor Belt Tensioning	72-78 Hz	6.8 ± 0.3 lbs [3.08 ± 0.14 kg] measured using Z-Drive Belt Tensioning procedure
X-Carriage Drag (Friction)		5.5-9.5 lbs, Disconnect motor from control board
Y-Carriage Drag (Friction)		10-25 lbs [4.5-11 kg], Disconnect motor from control board

The following lists the X and Y home positions attained when the “Set Home” function is initiated on the machine.

X Home: centered within ± 0.015 inches [0.4 mm]

Y Home: carriage mounting holes positioned 7.09 ± 0.015 inches [180 ± 0.4 mm] (relative to needle plate hole)

BERNINA

Torque Specifications

The following chart depicts the torque specifications for all screws and nuts used in the machine. They should be followed unless indicated otherwise in this manual (i.e., screws going into plastic materials require lower torque).

 *Note: Reduce torque specifications when attaching optical sensors by 10% to prevent damage to the sensor housing. Use minimum torque when screwing into or clamping plastic surfaces.*

Size	Min	Max	Min	Max
	In-lb	In-lb	N-m	N-m
Zn Plated, Property Class 8.8, Socket Head Screws (PN: 010170-XX, 010171-XX, 010172-XX, 010174-XX, 010175-XX)				
M2.5	5	7	0.66	0.80
M3	10	13	1.2	1.4
M4	23	26	2.6	3.2
M5	46	56	5.1	6.3
M6	79	96	8.9	10.9
M8	190	234	21.6	26.4
Zn Plated, Property Class 4.5, Slotted and Phillips Machine Screws (PN: 006558-XX, 004262-XX, 009862-XX, 009863-XX)				
M2.5	1	2	0.19	0.23
M3	3	4	0.40	0.48
M4	8	10	0.92	1.12
M5	16	19	1.8	2.2
M6	27	33	3.1	3.7
M8	45	55	5.1	6.3
Black Oxide, Property Class 12.9, Black Socket Head Screws (PN: 01922-XX, 67018-XX, 671852-XX, 671686-XX, 671687-XX, 003183-XX)				
M2.5	10	12	1.2	1.4
M3	18	22	2.1	2.5
M4	43	51	4.7	5.8
M5	83	100	9.4	11.4
M6	144	175	16.2	19.8
M8	345	418	38.7	47.3
Set Screws, Property Class 45H (PN: 10188, 01962-XX, 005034-XX, 001960-XX, 10635-XX, 001971-XX)				
M3	4	5	0.45	0.55
M4	8	10	0.90	1.10

BERNINA

Size	Min	Max	Min	Max
M5	24	29	2.7	3.3
M6	40	48	4.5	5.5
M8	80	97	9	11
Zn Plated, Property Class 8.8, Low Profile Socket Head Screws				
PN: 30750-XX				
M4	23	28	2.61	3.19
Black Oxide, Property Class 10.9, Flat Head Socket Screws (PN: 001935-XX, 007443-XX)				
M3	15	19	1.73	2.11
Zn Plated, Property Class 10.9, Flat Head Socket Screws (PN: 011197-XX, 011198-XX)				
M4	34	40	3.77	4.61
M5	65	78	7.29	8.91
Zn Plated, Property Class 12.9, Flanged Socket Head Screws (PN: 30790-XX)				
M4	40	48	4.45	5.45
Stainless Steel, Property Class 10.9, Button Head Cap Screws (PN: 011161-XX, 011162-XX, 011163-XX)				
M3	15	19	1.73	2.11
M4	34	40	3.77	4.61
M5	65	78	7.29	8.91
Zn Plated, Property Class 04, Metric Hex Nuts (PN: 680430-XX) (Torque based on screws they attach to)				
M4	23	28	2.6	3.2
M5	46	56	5.2	6.3
Machine Specific and Custom Hardware				
Self Tapping Plastic DURO Screw (PN: 30737-01)	8	10	0.9	1.10
M6 Lock Nut (PN: 005284-01)	Install nut until it makes contact with the spring washer, then turn nut another half turn.			
M4x0.7 Nylock Nut (PN: 003573-04)	No torque specification for this nut. Turn nut until specified belt tension is achieved.			

Software Maintenance Menus

In order to access the maintenance menus in the software, the machine must be turned on and software must be loaded and launched.

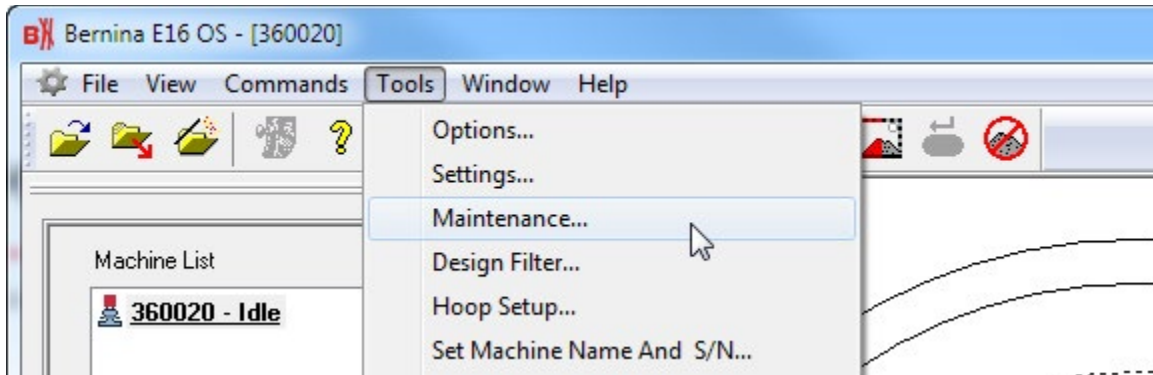

Figure 1 - Software Main Menu

To access the maintenance menu, select the "Tools>Maintenance" from the main menu. The screen below will open.

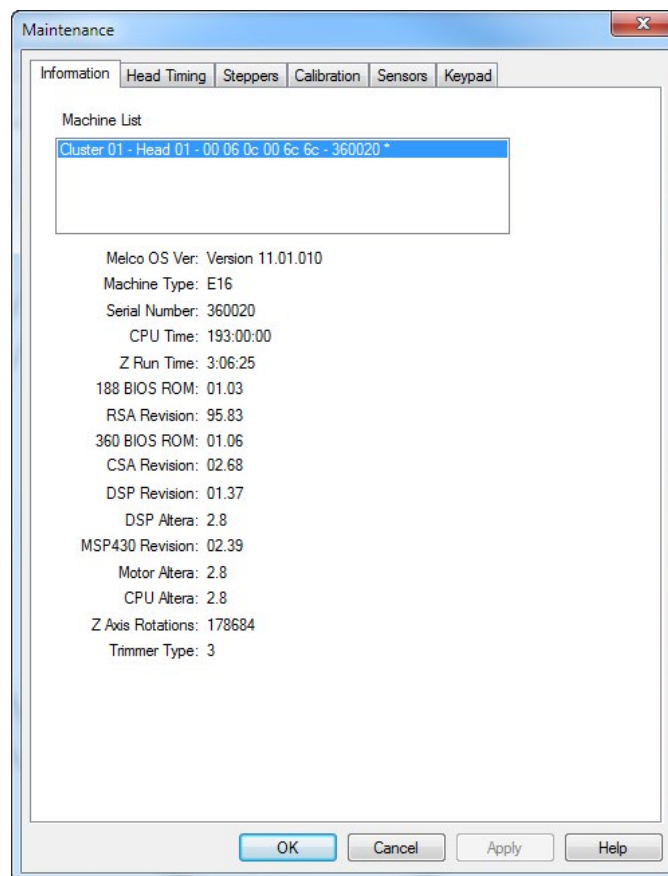

Figure 2 - Maintenance Menu

Special Tools and Fixtures

The following fixtures and special tools are required to perform certain procedures and repairs described in this manual:

- Fixture, Y-Belt Tensioning (PN: 32108)
- Force Gauge (0-40 lbs.) (PN: 995595-01)
- Force Gauge (0-10 lbs.) (PN: 995591-01)
- Universal Force Gauge Adapter (PN: 32498)
- Head Timing Dial Indicator Gauge (PN: 32453-01)
- Head Timing Adaptor Fixture (PN: 33065)
- 3 lb. Weight (PN: 32434)
- Hook Retaining Finger Gauge (PN: 009027-01)
- Take-Up Lever Timing Fixture (PN: 32413)
- Needle Depth Fixture (PN: 32650)
- Fixture, Z Home Flag (PN: 32980)
- Pin, Gauge, Thread Feed Gear (PN: 32996)
- Gauge, Height, Take-Up Lever (PN: 33017)
- 12 Gram Weight (PN: 10082)
- Metric Ruler
- Feeler Gauge Set

All of the above fixtures can be ordered through the manufacturer.

It is strongly recommended that the fixtures recommended in this manual are used. Making adjustments without the proper tools and fixtures can result in poor performance or damage to the machine. The machine is dependent on proper maintenance and adjustment in order to produce high quality embroidery.

General Maintenance

This section describes the procedures involved in maintaining your machine. This section is very important, because maintenance is essential to the performance of your machine.

Cleaning

It is very important that you clean your machine regularly. Dust and lint accumulation can damage both electrical and mechanical systems.

Exterior Surfaces

Clean outer surfaces once per month with a soft, clean cloth, a mild detergent and water. Wring out the cloth before wiping the surfaces. Do not get water or any other fluids inside the machine or on any of the working mechanical surfaces.

If an accidental spill occurs, turn the machine off then wipe up excess fluid with a clean dry cloth and allow the machine to dry completely before turning the power on.

Interior Surfaces (PCB)

The main PCB can be damaged by dust accumulation. It is important that you periodically remove this accumulation. To do so, complete the following steps:



CAUTION!! Before proceeding, turn the machine off, but leave it plugged in.

1. Remove the base cover. You will see the EMI shield covering the main PCB.
2. Remove the screw(s) that hold the EMI shield in place.

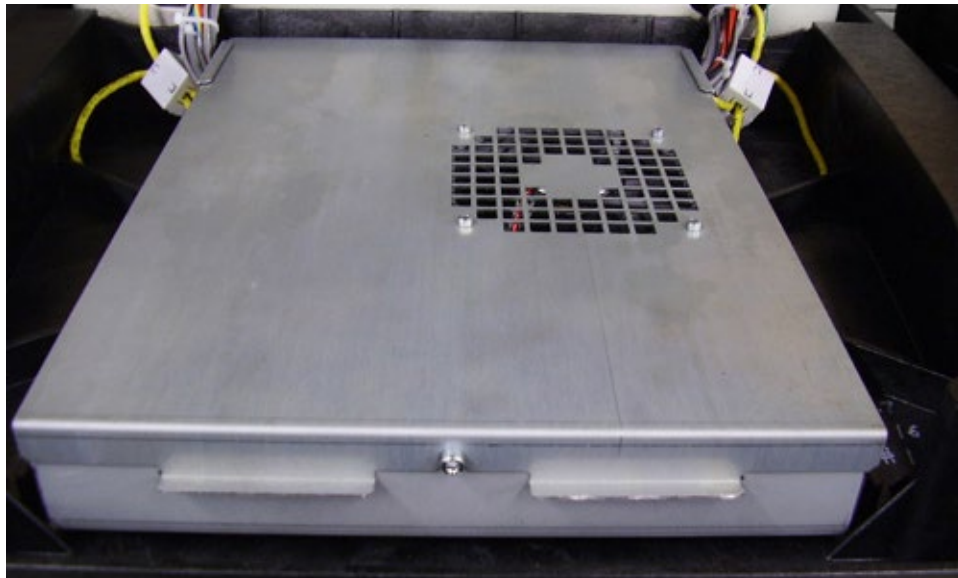

BERNINA

3. Carefully lift the EMI shield from the main PCB. If required, disconnect the fan connector from the main PCB.



CAUTION!! Be careful not to drop metallic hardware or tools onto the Main PCB while it is exposed. Doing so can result in severe damage to the electronics that might be expensive to repair.

4. Use any compressed air labeled as ESD safe (and labeled for use on electronic components) to blow any accumulated dust out of the base interior. When doing so, do not touch the main PCB.

Some compressed air brands have a liquid accelerant that is discharged from the container while blowing dust off the machine. Always allow any liquid discharge to completely evaporate before turning the machine back on.

5. Carefully place the EMI shield over the main PCB and re-install the screws.
6. Replace the base cover before turning the machine back on.

Rotary Hook and Trimmer Assembly area

Lint and dust can build up in the trimmer assembly and the rotary hook. Clean this at least once per day.

1. Turn off the machine.
2. Remove the needle plate by removing the two screws on the underside of the extrusion.
3. Clean the exposed area with canned or compressed air.



Note: Excessive thread or lint buildup may require removal or disassembly of the trimmer.

You should also frequently check this area for loose thread.

If you are frequently performing applications that require you to use adhesive spray, it is recommended that you clean the rotary hook area at least once a day with a lightweight lubricant spray (such as WD-40). To do this:

1. Turn off the machine.
2. Remove the needle plate by removing the two screws on the underside of the extrusion.
3. Clean the exposed area with canned or compressed air.
4. Spray the exposed area with a lubricant spray.
5. Turn the machine back on, then rotate the hook all the way around a couple of times.
6. Spray the exposed area with canned or compressed air again.
7. Re-install the needleplate.

BERNINA

Lubrication Schedule and Specifications

Tools and supplies needed for these procedures are provided in your operator's kit.

Using the correct lubricants properly and when specified by scheduled maintenance is critical to the operation of the machine. Failure to use the proper lubricants as specified can shorten the usable life of internal components and can void the warranty. Using the wrong lubricants can adversely affect your machine. The recommended and authorized lubricants to be used on the machine are specified below:

Part Number:	Part Name	Comments
761003-01	Oiler, 3/4 oz. bottle	Sewing Machine Oil
32078	Grease, EMB-Polymer, 8 oz bottle	Polymer Light Grease
34463	Grease, HP, 8 oz bottle	High Performance Grease

Maintenance in the User Interface



The Maintenance button opens the maintenance screen. The maintenance screen will also open when maintenance is due. From here the hook, weekly, monthly, and quarterly maintenance procedures may be initiated. Procedures that are due are indicated by a clock icon. 

Each procedure will show a walk-through with images and text as well as move the machine to the appropriate position for each step.

Maintenance Schedule

The following table summarizes the lubrication points and schedule for your machine. The table also lists which type of lubrication you should use for each lubrication point.

Please note that these schedules are meant to be used as guidelines. Depending on many circumstances (such as environment, garment types sewn on, etc.), you may need to lubricate your machines more or less frequently. Follow a lubrication schedule that best fits your needs to take care of your machine(s).



WARNING! Do not attempt to lubricate the machine while it is in operation.



Important: The color change lead screw is lubricated for life and should NEVER be lubricated by the user or a technician.

Daily Maintenance

Lubrication Point(s)	Lubrication Used
Rotary Hook	Sewing Machine Oil

Weekly

Lubrication Point(s)	Lubrication Used
Needle Drive	Sewing Machine Oil

BERNINA

Lubrication Point(s)	Lubrication Used
Left Upper V-Rail	Sewing Machine Oil
Right Upper V-Rail	Sewing Machine Oil
Oil Needle Bars (Lower)	Sewing Machine Oil
Oil Needle Bars (Upper)	Sewing Machine Oil

Monthly

Lubrication Point(s)	Lubrication Used
X-Drive Rails	HP Grease
Y-Bearing Blocks	Sewing Machine Oil
X-Cable Tension (Test)	
Grabber Eccentric	HP Grease

Quarterly

Lubrication Point(s)	Lubrication Used
Take-Up Lever Cam, Presser Foot Cam Follower, & Right Needle Bar Guide	HP Grease
Presser Foot Cam & Left Needle Bar Guide	HP Grease
Thread feed Rollers and Pinch Rollers	EMB Grease

Yearly

Lubrication Point(s)	Lubrication Used
Wide Angle Driver	HP Grease

The following belts should be checked once a year: Y-Axis Timing Belt, and Z-Drive Belt. You can either have a Service Technician check these belts for a charge, or you can perform these checks yourself. To perform these checks, you will need to purchase the following tools / fixtures and follow the procedures in this Technical Manual.

- Fixture, Y-Belt Tensioning (PN: 32108)
- Force Gauge (0-10 lbs.) (PN: 995591-01)
- Universal Force Gauge Adapter (PN: 32498) see Y-axis timing belt Tensioning , Z-drive Belt Tensioning sections



CAUTION!! Some of the lubrication procedures instruct you to remove the right/left front covers. Do not turn the machine off, then on again when either of these covers is removed. This will cause the machine to color change, which will cause the needle bars to fall out. Do not move the needlecase at all when either of the front covers is removed. If you proceed without this cover damage to your machine will occur and a service call will be necessary.

BERNINA



Disclaimer: The manufacturer will not be held responsible for any damage to the machine from not performing this step.

Daily Maintenance

Rotary Hook

The rotary hook should be oiled approximately every 4-5 hours of solid running. This will keep the machine running smoother, quieter, and prevent thread breaks.



WARNING!! *Never attempt to remove or insert the bobbin with the machine is in operation.*

1. If you have a product on the machine, please remove it to avoid oil spots.
2. Remove the bobbin case. It can be removed from the lower arm of the machine by locating the release lever on the bobbin case.



3. Pull forward on this lever until the case is free from the machine.
 - This would also be a good time to clean and test the tension the bobbin case.
4. Clean the rotary hook and trimmer area with a brush or canned air.



- a. Keeping this area clear of lint and debris will help ensure proper trimming and reduce thread breaks.
5. Using a small oiler bottle, apply one (1) drop of sewing machine oil to the hook oiling area. This area is highlighted in green in the photograph.

BERNINA

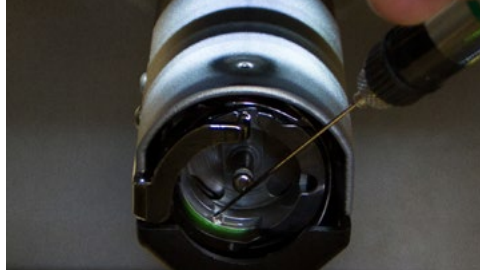

6. This is now a good time to clean, rethread, and Insert the bobbin and case into the machine with the pigtail facing up. Push on the bobbin case until it snaps into place.

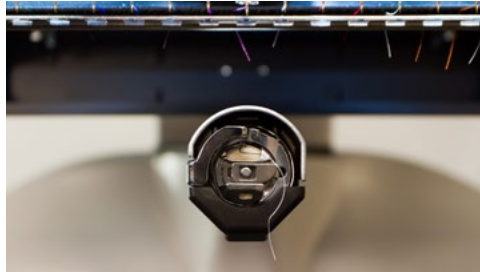

7. Trim the thread to 2-3 inches.

This completes the hook maintenance procedure.

Weekly Maintenance



WARNING!! *If you currently have a hoop or clamping system on the machine, please remove it. Failure to fully remove a clamping system can result in damage to the machine.*

Needle Drive

1. Color change to Needle 16.
2. Go to "Tools>Maintenance>Head Timing Tab".
3. Go to "Top Center"
4. Using a small oiler bottle, put twenty-five drops (25) of sewing machine oil in the oiling change as shown in the image.



Note: You may have to add a few drops and wait before adding more to prevent the channel from overflowing.

BERNINA



5. After adding the oil, wait ten minutes before continuing.
6. In the Head Timing Tab, go to "Head Up".

Left Upper V-Rail

7. Using a piece of lint-free cloth, wipe clean both the front and back surfaces of the upper v-rail on the LEFT side of the needlecase.



8. After cleaning the v-rail, use a small oiler bottle to apply a drop of oil each to the front and the back surfaces of the v-rail. Apply the oil close to the needlecase.

Right Upper V-Rail

9. Color change to needle #1.
10. Using a piece of lint-free cloth, wipe clean both the front and back surfaces of the upper v-rail on the RIGHT side of the needlecase.



11. After cleaning the v-rail, use a small oiler bottle to apply a drop of oil each to the front and the back surfaces of the v-rail. Apply the oil close to the needlecase.

Oil Needle Bars (Lower)

12. Using a small oiler bottle, apply one (1) drop of sewing machine oil to each of the sixteen (16) needle bars through the hole in the needlecase as shown in the image.

BERNINA



Oil Needle Bars (Upper)

13. Using a small oiler bottle, apply one (1) drop of sewing machine oil to each of the sixteen (16) needle bars by guiding the oiler applicator through the vertical slots of the needlecase cover just below the take up lever arms as shown in the image.



14. Close out of the Head Timing Tab.

This completes the weekly maintenance procedure.

Monthly Maintenance

X-Drive Rails

WARNING!! *If you currently have a hoop or clamping system on the machine, please remove it. Failure to fully remove a clamping system can result in damage to the machine.*

1. Move the x-beam all the way forward and all the way to the left using the hoop and the arrow keys on the keypad.
2. Remove the end cap cover on the right side of the x-beam as shown in the image.



BERNINA

3. Wipe any lint, dust, and old grease from the front and back steel rails inside the x-beam as shown in the image.



4. Using a clean piece of cloth, apply a thin film of HP grease to the front and back steel rails inside the x-beam as shown in the image.



5. Replace the end cap cover that was previously removed.
6. Remove the end cap cover on the left side of the x-beam as shown in the image.



7. Wipe any lint, dust, and old grease from the front and back steel rails inside the x-beam as shown in the image.



8. Using a clean piece of cloth, apply a thin film of HP grease to the front and back steel rails inside the x-beam as shown in the image.

BERNINA



9. Replace the end cap cover that was previously removed.
10. Press the hoop and the center key on the keypad of the machine to move the arms back to center.

Y-Bearing Blocks

11. Color change to move the needle case to needle #16.
12. Using a 3mm Allen wrench, loosen and remove the three (3) screws securing the left side cover as shown in the image.

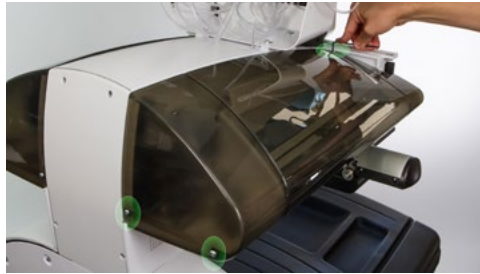

i *Note: The screw in the front of the cover is slightly longer than the two (2) rear screws. Ensure that you use the same screws for the original position later in this procedure.*

13. Remove the left side cover from the machine.
14. Using a small oiler bottle, place twenty five (25) drops of sewing machine oil into the oiling port as shown in the image.

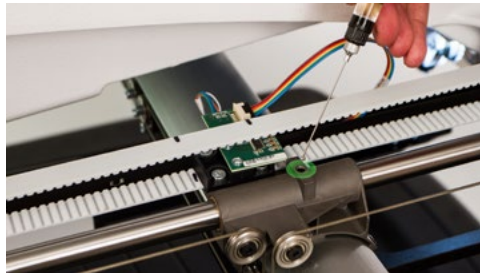

i *Note: You may need to add a few drops and wait before adding more to prevent the oiling port from overflowing.*

15. Position the left side cover in its original location on the machine as shown in the image.

BERNINA

16. Loosely install one (1) of the rear (shorter) mounting screws to hold the cover in place.
17. Install the other two (2) mounting screws. The longer of the screws secures the front. The shorter of the screws secures the rear.
18. Carefully tighten all three (3) screws only enough to secure the cover in place. Over-tightening of the screws may result in cosmetic damage to or cracking of the cover.

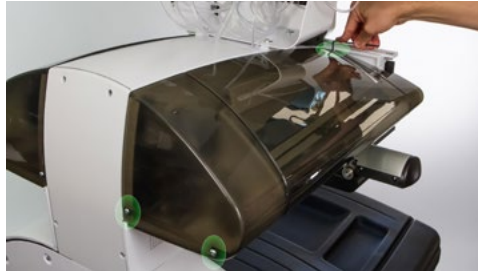

19. Color change to move the needle case to needle #1.
20. Using a 3mm Allen wrench, loosen and remove the three (3) screws securing the right side cover as shown in the image.



 *Note: The screw in the front of the cover is slightly longer than the two (2) rear screws. Ensure that you use the same screws for the original position later in this procedure.*

21. Remove the right side cover from the machine.
22. Using a small oiler bottle, place twenty five (25) drops of sewing machine oil into the oiling port as shown in the image.



 *Note: You may need to add a few drops and wait before adding more to prevent the oiling port from overflowing.*

BERNINA

X-Cable Tension (Test)

23. Position the x-cable tension gauge (P/N 33909) on the x-cable as shown in the image.



24. Determine if the cable tension is within specification.

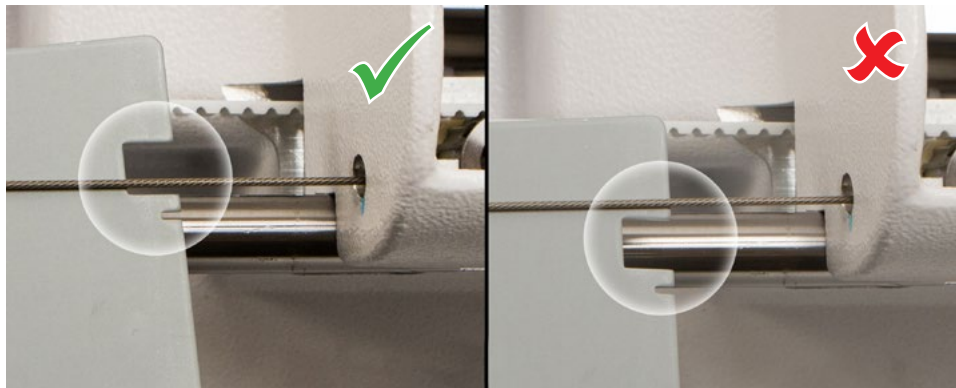

- If the x-cable is positioned within the large cut-out on the right side of the x-cable tension gauge as shown in the image, the tension is within specification. Continue to step 25.
- If the x-cable is not positioned within the large cut-out on the right side of the x-cable tension gauge as shown in the image, the tension is out of specification and needs adjustment.
 - a. Remove, but do not discard, the side cover support foam.
 - b. Locate the M4 nut and the x-cable tension stud and the end of the x-cable where it mounts to the front of the upper arm as shown in the image.



- c. Using a 7mm wrench, grip the M4 nut and with a pair of pliers or adjustable wrench, grip the x-cable stud at the end of the x-cable as shown in the image.

BERNINA

- d. To increase tension, rotate the M4 nut with the wrench counter clockwise while holding the x-cable stud with the pliers or adjustable wrench.
- e. When the x-cable is roughly at the lower edge of the cut-out on the right side of the tension gauge, remove the wrench, pliers and the tension gauge.
- f. Remove the tools and the x-cable tension gauge before proceeding.
- g. Move the X-Beam full travel to the front and back and the X-Carriage full travel left and right a few times to ensure proper settling of the X-Cable tension.
- h. Test the tension again.

25. Remove the x-cable tension gauge before proceeding.



WARNING!! *If you proceed without removing the x-cable tension gauge, damage to your machine will occur and a service call will be necessary.*



Note: BERNINA will not be responsible for any damage to the machine or related service costs caused by not removing the tension gauge.

26. Position the right side cover in its original location on the machine as shown in the image.



27. Loosely install one (1) of the rear (shorter) mounting screws to hold the cover in place.
28. Install the other two (2) mounting screws. The longer of the screws secures the front. The shorter of the screws secures the rear.
29. Carefully tighten all three (3) screws only enough to secure the cover in place. Over-tightening of the screws may result in cosmetic damage to or cracking of the cover.
30. If the x-cable is not positioned near the lower edge of the cut-out on the right side of the x-cable tension gauge as shown in the image, the tension is out of specification and needs adjustment. If this is the case, press on the out of specification button to continue.
31. Locate the grabber eccentric on the upper left back side of the needlecase as shown in the image.

BERNINA



32. With a small flat blade screwdriver, carefully move and hold the grabber connecting lever over to the left as shown in the image.

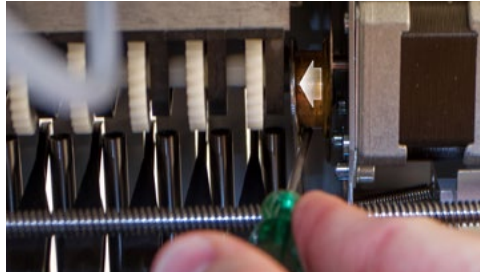

33. Using the grease applicator, apply a small amount of HP grease onto the grabber eccentric surface between the grabber connecting lever and the grabber home flag as shown in the image.



i **IMPORTANT:** Ensure that no grease is applied to the black grabber flag on the right side.

34. Once the grease has been applied, release the grabber connecting lever and remove the small screwdriver.

This completes the monthly maintenance procedure

Quarterly Maintenance

Take-Up Lever Cam, Presser Foot Cam Follower, & Right Needle Bar Guide

! **WARNING!!** If you currently have a hoop or clamping system on the machine, please remove it. Failure to fully remove a clamping system can result in damage to the machine. When you click on the next button, the machine will move to the appropriate position.

1. Color change to needle #1.

BERNINA

2. Move the x-beam all the way back.
3. In the software, go to "Tools>Maintenance> Head Timing Tab" and got to "Bottom Center".
4. Using a 3mm and a 2.5mm Allen wrench, loosen and remove the five (5) screws shown in the image.



5. After removing the mounting screws, move the right upper arm front cover slightly away from the machine. Then, rotate it counter clockwise as shown in the image and remove it completely from the machine.



6. Using the grease applicator, apply some HP grease to the back surface of the take-up Lever Cam as shown in the image.



7. To gain access to the next maintenance point, the presser foot must be manually raised. Place a finger below the back bend of the presser foot and lift the presser foot as shown in the image.



8. Using the grease applicator, apply a small amount of the HP grease to the upper presser foot cam follower.

BERNINA





9. Position the right upper arm front cover in its original location. You will need to rotate it back into place in the reverse of the way it was removed.



10. Reinstall the five (5) mounting screws to hold the cover in place. It is important to leave them just loose enough that the cover can still move, but make sure that the screws are in far enough that they will not catch the needlecase as it moves over them.

The screws will be fully tightened in a future step.

 *Important: Ensure that the button head screw is installed in the lower left side location of the cover as shown in the image.*

 **WARNING!!** *If you proceed without mounting the right upper arm front cover, damage to your machine will occur and a service call will be necessary.*

 *Note: BERNINA will not be responsible for any damage to the machine or related service costs caused by not performing this step.*

11. Color change to needle #12.
12. With the needlecase holding the right upper arm cover in the appropriate position, tighten the two screws in the right side of the upper arm front cover as shown in the image.

BERNINA



13. Color change to needle #1.
14. Now tighten the three remaining screws on the left side of the right upper arm front cover as shown in the image.



15. With a clean piece of cloth, wipe clean the needle bar guide channel indicated in the image. The image uses cloth wrapped around the grease applicator for better control of the cloth.



16. With a clean piece of cloth, apply a thin film of HP grease to the inside of the channel as shown in the image.

17. Color change to needle #16.

18. Using a 3mm Allen wrench, loosen and remove the four (4) screws shown in the image.



19. After removing the mounting screws, move the left upper arm front cover slightly away from the machine. Then, rotate it clockwise as shown in the image and remove it completely from the machine.

BERNINA



20. Locate the presser foot cam as shown in the image.

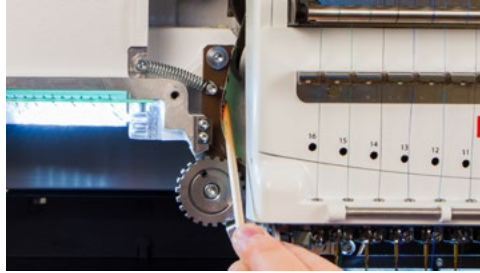

21. With the grease applicator, apply a small amount of HP grease spread fairly evenly along the entire right side of the presser foot cam as shown in the image.
22. Position the left upper arm front cover in its original location. You will need to rotate it back into place in the reverse of the way it was removed.



⚠ WARNING!! *If you proceed without mounting the left upper arm front cover, damage to your machine will occur and a service call will be necessary.*

i *Note: BERNINA will not be responsible for any damage to the machine or related service costs caused by not performing this step.*

23. Color change to needle #5.
24. With the needlecage holding the left upper arm cover in the appropriate position, tighten the two screws in the left side of the upper arm front cover as shown in the image.

BERNINA

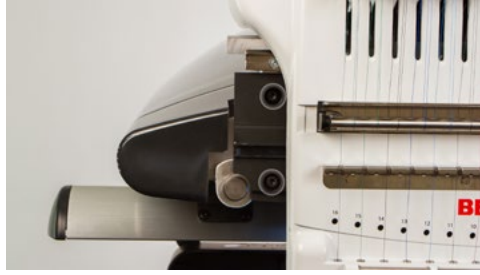

25. Color change to needle #15.
26. Now tighten the two (2) remaining screws on the right side of the left upper arm front cover as shown in the image.



27. With a clean piece of cloth, wipe clean the needle bar guide channel indicated in the image. The image uses cloth wrapped around the grease applicator for better control of the cloth.



28. With a clean piece of cloth, apply a thin film of HP grease to the inside of the channel as shown in the image.
29. Color change to needle #8.
30. Lift all sixteen (16) thread feed roller arms as shown in the image.



Although not necessary, it is helpful to move the threads up between the rollers and out of the way.

BERNINA

31. With a small flat blade screwdriver or your fingernail, disengage all sixteen (16) thread feed front covers and remove them from the machine.



32. Using two thin-bladed flat screwdrivers or the thread feed gear removal tool, carefully remove the thread feed rollers out of the assembly. This can be accomplished by sliding one screwdriver along each side of the roller and prying against your fingers as shown in the image.



Set the rollers to the side. They will be cleaned and inspected in future steps.

i *Important: Do not get grease on the thread feed surface of the roller.*

33. Using a clean cloth, remove any lint and old grease from the cradle that holds the rollers. In the image, this is done with the cloth wrapped around the grease applicator for better control of the cloth.

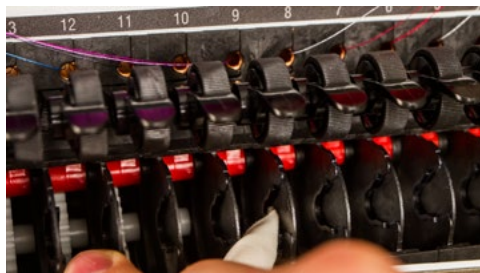

34. Using a clean, dry cloth, thoroughly clean the entire surface of the thread feed roller. Remove any lint or grease.

BERNINA



Important: Do not get grease on the thread feed surface of the roller.

35. Inspect the roller for wear, nicks, or grooves that may catch thread. If the roller is damaged, replace it with a new one.
36. Using the image as a guide, apply three (3) small dots of EMB Polymer grease to the side of the hub. Do this for each side of the thread feed roller.



37. Carefully reinstall the thread feed roller. The gear side of the roller should fall to the left. Align the roller with the slot and gently press forward and down until the roller snaps into place.



Take care to clean up any grease that may transfer to the front of the slot.

38. Reinstall the front covers by holding them at the bottom and tilting them up. Insert the top of the cover into the slot at the top of thread feeder assembly. You will probably feel a slight click as it locks into place.

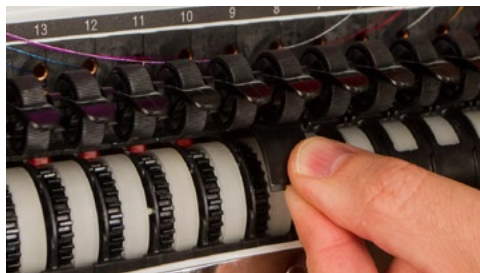

BERNINA

39. Rock the cover forward and down until it snaps into place. Keep in mind that the covers overlap and will reinstall easiest starting with needle 1.
40. Next you need to remove the pinch rollers. This is easiest if you leave the thread feed levers up. Then steady the lever with one hand and pull the roller to the right with the other. This will release it from the hub.

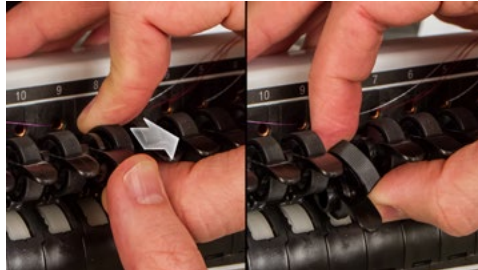

41. Next, lower the lever and angle the roller. It can then be pulled forward and free from the machine. If the lever beside the roller is in the way, gentle pressure may be applied to move it slightly out of the way.

Set the rollers to the side. They will be cleaned and inspected in future steps.

i *Important: Do not get grease on the pinch surface of the roller.*

42. Using a clean cloth, clean all the old grease, lint, and residue from the lever hub. In the image, the cloth was wrapped around the grease applicator for better control.



43. Using a clean, dry cloth, thoroughly clean the entire surface of the thread feed roller. Remove any lint or grease.



i *Important: Do not get grease on the pinch surface of the roller.*

BERNINA

44. Inspect the roller for wear, nicks, or grooves that may catch thread. If the roller is damaged, replace it with a new one.
45. Using EMB Polymer grease, apply a small amount of grease to the lever hub as shown in the image.

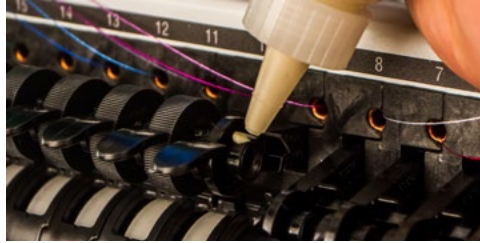

46. Using EMB Polymer grease, apply a tiny amount of grease to the outer surface of one (1) of the three (3) small pegs inside the pinch roller as shown in the image.



47. With one lever up and one lever down, hold the pinch lever at an angle and slide it back into place.



48. Rock it back onto the hub and slowly rotate to begin spreading the grease evenly around the hub.
49. Snap the roller back onto the hub and spin the roller to ensure that it is locked into place and the grease is spreading evenly.
50. If you moved the threads originally, move them back into place.
51. Align the threads onto the v-notch in the front cover and lower thread feed levers.



This completes the quarterly maintenance procedure.

Thread Cutter Blade Replacement

1. Remove the needle plate by removing the two screws from the bottom of the lower arm using a 2.5mm hex wrench.

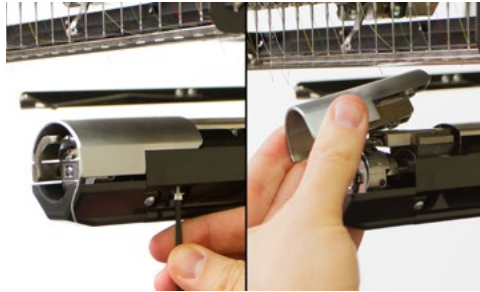

2. Remove the hook guard by loosening the screws on both sides of the lower arm using a 2mm hex wrench, and sliding the hook guard forward. The screws do not need to be completely removed.



3. Remove the two thread cutter blade screws carefully, using the small flat blade screwdriver provided in the thread cutter replacement kit.
4. Remove the thread cutter blade and replace with a new one provided in the thread cutter replacement kit.

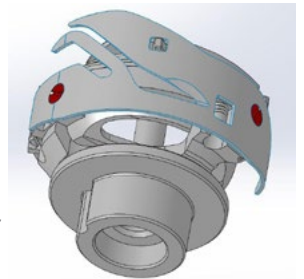

i Do not try to sharpen the thread cutter blade, precision is very important for proper functionality.

5. Before inserting the screws in to the cutter blade, apply a very small amount of Loctite 222 (provided in the thread cutter replacement kit) to the threads of the two cutter blade screws.
6. Insert and tighten the two thread cutter blade screws.
7. Reassemble the hook guard removed in step two.
8. Reassemble the needle plate. Ensure that the needle plate hole is centered to the needle prior to fully tightening the needle plate screws. (See reverse side for centering procedure.)

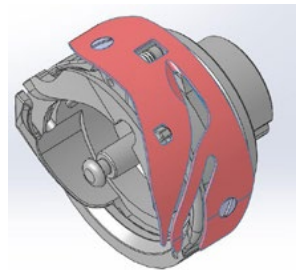

Centering The Needle Plate

1. Center the needle plate as best you can by feel and by eye.
2. Lower the needle to its bottom most rotation. This can be done manually by pressing the e-stop and rotating the z-shaft to control the decent of the needle.



3. With the needle lowered, loosen the screws securing the needle plate, and center the hole in the needle plate around the needle.



4. Tighten the screws securing the needle plate.
5. Raise the needle back up by releasing the E-stop button. Turn the button a quarter turn in the direction of the arrows and release.

Mechanical Head-Up Position



Figure 1 - Reciprocator Drive Groove at "Head Up" Position

Mechanical head up is when the drive slot of the reciprocator (the part that engages the drive stud on the needle bar) is aligned with the needle bar drive slots on the left and right upper arm front covers.

Checking Electrical Head-Up (Z-Home) Position:

Electrically, head up is correct when the mechanical head up is set and the z-position reading on the Head Timing menu is $26^\circ \pm 1^\circ$. Head up should not be confused with top dead center which is different. When the mechanical head up position is read and you click on the Head Up button in the Head Timing menu and the reading of the Z-position is $26^\circ \pm 1^\circ$ the machine is considered to be "timed."

1. Remove the needlecase access cover and the needlecase cover.
2. Launch the software.
3. Turn on the machine.
4. Click Tools>Maintenance in the main menu and then click the Head Timing tab.
5. Click the Head Up command button. This will take the machine to electrical "Head-Up" position.
6. Click the Bottom Center button. This will put the machine at electrical "bottom center" or "needle depth."
7. Click Unlock Z. This will release the Z-motor.
8. Note the Current Z Position reading on the control panel. It should read from 179.5° to 180.5° .
9. Grab the needle bar and pull down on it. This will bring the bar and the z-shaft to the lowest point in its movement.
10. Note the Current Z Position reading on the control panel. If it does not read between 179.5° to 180.5° , proceed to Adjusting Head-Up. If it reads between 179.5° to 180.5° , then the machine is timed.

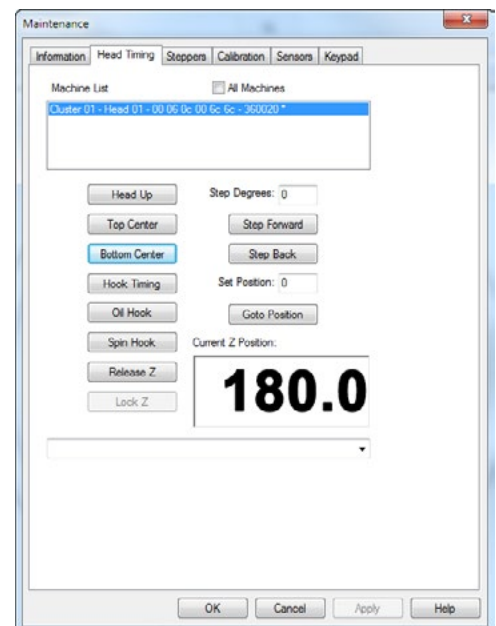



Figure 3 - Head Timing Menu

Adjusting Head-Up (Z-Home) Position:

 *This procedure is performed after Checking Head Up procedures above are completed. This procedure is also referred to as Head Timing.*

1. Remove the left arm cover and remove the back screw from the right arm cover.
 2. Remove the upper arm back cover.
-

 **CAUTION!!** *Use extreme care not to drop metallic objects, tools, or other conductive material on the Main PCB when you have the base cover removed. If you drop such objects on the Main PCB, it can severely damage the electronics, which will be very expensive to repair.*

3. Remove the base cover.
 4. Click the Head Up button in the Head Timing tab.
 5. Click the Bottom Center button and then the Release Z button.
 6. Pull down on the needle bar and note the Current Z Position reading in the Head Timing tab. If it is not between 179.5° and 180.5° , loosen the two screws on the z-home flag and rotate the flag clockwise or counterclockwise depending on the Current Z Position reading.
-

 **NOTE:** *A small adjustment will change the reading substantially. Make small, incremental adjustments.*

7. Tighten the z-home flag screws.
8. Click the Lock Z button.
9. Click the Head Up button twice to reset the electronics to the newest settings.
10. Click the Bottom Center button and then the Release Z button.
11. Pull down on the needle bar and note the Current Z Position reading. If the Current Z Position reading is between 179.5° and 180.5° , the machine is timed. If the Current Z Position reading is still out of this range, repeat steps #4 through 11 until the Current Z Position reading is between 179.5° and 180.5° .
12. When have completed the internal adjustments, install all of the covers previously removed from the machine and tighten the hardware to The torque specifications.

Hook Timing Inspection/Adjustment

It is recommended that you read the Head Timing Tab section before performing hook timing inspection/adjustment.

It is possible for the machine rotary hook to slip from the factory-set hook timing. Inadequate timing between the hook and the needle can be one of the causes of upper thread breaks. The following inspection procedure will allow you to check the hook timing of your machine(s). If the hook timing position needs to be adjusted, follow the provided adjustment procedures.

Before making any hook timing changes, you need to perform an inspection to determine if adjustment is needed.

The procedures below refer to the part of the rotary hook called the “hook point.” See the image below for the location of the hook point.



List of Tools

- Hex Wrench, 2mm
- Hex Wrench, 2.5mm
- Hex Wrench, 1.5mm bent, short arm
- Magnifying Glass (Optional)
- Flashlight (Optional)

Rotational Hook Timing Inspection Procedure

1. Make sure your machine is turned on and BERNINA E16 OS is running.
2. Engage the emergency stop button (by pushing it in).
3. Push the x-beam all the way to the back of the machine to ensure that the hoop arms will be out of the way during the procedure. (As an alternative to this, you could remove the hoop arms.)
4. Remove the needle plate, bobbin case, and rotary hook cover (using 2mm Hex wrench).
5. Disengage the emergency stop button (by twisting it).
6. You now need to determine the machine’s “closest needle.” The closest needle is defined as the needle that is closest to the hook point. The number of the closest needle is noted in the bottom right corner of the machine casting (under the black base cover). Lift the base cover, then make a note of the closest needle. The closest needle number is identified as C-X, where X is the needle number.

BERNINA



7. Replace the base cover.
8. Open the Tools>Maintenance menu and then click the Head Timing tab.
9. In the Head Timing tab, click the Head Up button (or on the machine keypad, press the Adjustment key and the Up Arrow key).
10. Use the machine keypad to move the needle case to the closest needle noted in the machine casting.
11. If the needle is bent or damaged, replace the needle.
12. To inspect hook timing you need to adjust the machine to $201.5^\circ \pm 0.5^\circ$. Since the hook timing position is a whole number (use the Set Position box and the Goto Position button to move the machine to that z-axis position. To do this, enter 201 in the Set Position box, then click the Goto Position button. Check the number displayed in the Current Z Position box (see image below). This number may not be the exact number you entered. If it is not, use the microstep forward command on the keypad (press and hold the Trace key, then press the Up Arrow button to increase the z position by tenths (of degrees) until the correct hook timing position (201.5) is displayed in the Current Z Position box.

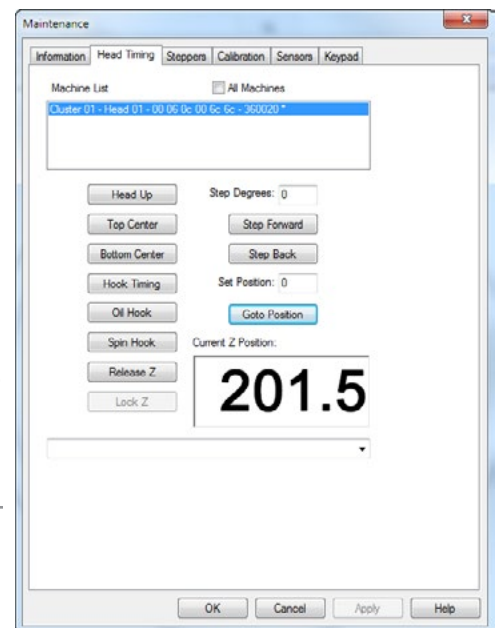

i **NOTE:** If you microstep too far, use the GoTo function of the software to move to 201° and microstep forward. Do not microstep backward.

13. You can now inspect the hook timing, which refers to the rotational position of the hook point in relation to the needle. To check the hook timing, stand directly in front of the machine, then locate the needle. The hook point should be even with the left side of the needle. Use the image below to locate the hook point behind the needle (it may be helpful to use a magnifying glass to see this).
14. The optimal hook point position is displayed in the image below. The hook point should be even with the left side of the needle. If the hook point is not even with the left side of the needle, you will need to perform a hook timing adjustment.

BERNINA

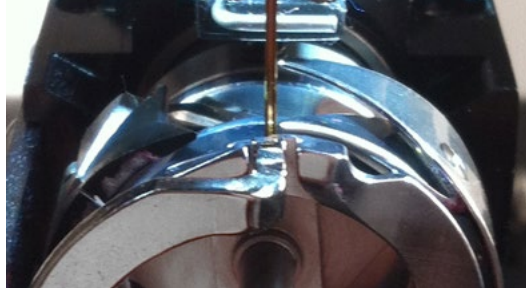

Needle To Hook Gap Inspection Procedure

15. You can now inspect the needle to hook gap (front to back position of the rotary hook).

The needle to hook gap refers to the gap between the hook point and the needle scarf. To check this gap, stand on the right side of the machine, then look behind the needle. You should see the hook point directly behind the needle scarf (it may be helpful to use a magnifying glass to do this). The space between the needle scarf and the hook point is the needle to hook gap. Use the following image to locate the gap.

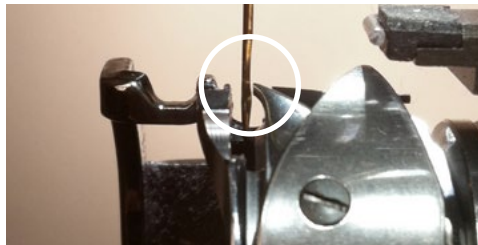

Once you have located the needle to hook gap, you can check the gap width. The width of the gap should be between 0.004 and 0.012 inches / 0.10 and 0.30mm (approximately 1-3 thread widths). As a guide, the image above displays the correct needle to hook gap width.

16. If the needle to hook gap or the rotational hook timing are not correct, proceed to the next section to perform hook timing adjustment.

Adjustment Procedure

1. Open the Tools>Maintenance menu and then click the Head Timing tab. Click the Head Up button (or on the machine keypad, press the Adjustment key and the Up Arrow key).
2. Use the machine keypad to move the needle case to the closest needle noted in the machine base.
3. If the needle is bent or damaged, replace the needle.
4. Start by checking the machine to the hook timing position ($201.5 \pm .5^\circ$)

Since the hook timing position is a whole number (use the Set Position box and the Go to Position button to move the machine to that z-axis position. To do this,

- a. Enter 201 in the Set Position box, then click the Go to Position button. Check the number displayed in the Current Z Position box (see image below).

BERNINA

- b. This number may not be the exact number you entered. If it is not, use the microstep forward command on the keypad (press and hold the press and hold the Trace key, then press the Up Arrow button) to increase the z position by tenths of degrees until the correct hook timing position (201.5) is displayed in the Current Z Position box.

i **NOTE:** *If you microstep too far, use the GoTo function of the software to move to 201° and microstep forward. Do not microstep backward.*

5. You can now adjust the hook timing if needed, using the following image as a guide.

To set the hook timing rotationally, align the hook point to the approximate hook timing position as shown in the following image. (The following image reflects the view of the needle and hook point when looking from the front of the machine).

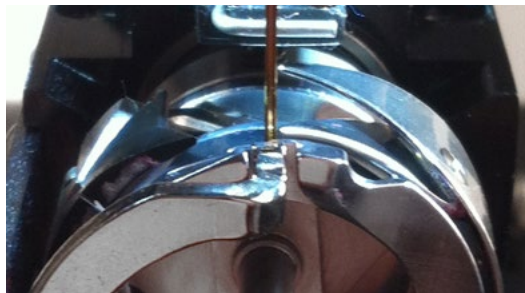

Remember the optimal position is such that the hook point is even with the left side of the needle. Please note that it is not uncommon to repeat the adjustment several times to obtain the correct hook timing.

6. Slightly loosen the two timing set screws (highlighted in blue in the image below) with a 2 mm bent hex wrench and then rotationally position the rotary hook so that the hook point is even with the left side of the needle. Lightly tighten each of the two timing set screws before fully tightening them.

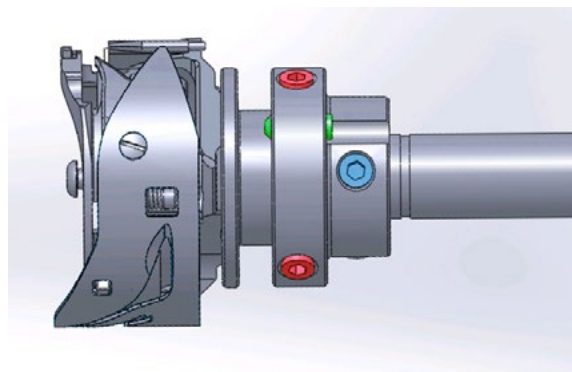

i **NOTE:** *While adjusting the needle to hook gap and/or hook timing, you should periodically make sure that the z axis position has not changed (check the Current Z Position box). If the z position has changed, repeat steps 4-6 of this procedure.*

BERNINA

7. Repeat step 4, then verify that the rotational hook timing is still correct. If it is not, repeat the rotational hook timing adjustment.
8. While still at 201.5°, check and adjust, if needed, the needle to hook gap.
9. Using a 2 mm bent allen wrench, slightly loosen (do not remove) the three exposed screws that are accessible on either side of the hook. The hook fastening screws are highlighted in red in the image below.

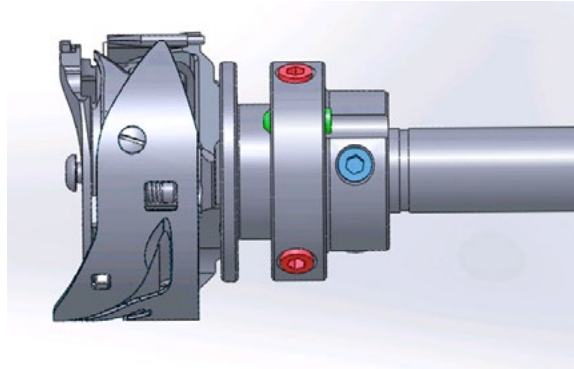

10. Since the hook timing position is a whole number (use the Set Position box and the Go to Position button to move the machine to that z-axis position. To do this,
 - a. Enter 201 in the Set Position box, then click the Go to Position button. Check the number displayed in the Current Z Position box (see image below).
 - b. This number may not be the exact number you entered. If it is not, use the microstep forward command on the keypad (press and hold the press and hold the Trace key, then press the Up Arrow button) to increase the z position by tenths of degrees until the correct hook timing position (201.5) is displayed in the Current Z Position box.
11. Adjust the hook to needle gap with a shortened 1.5mm bent Allen key to access the adjustment set screw (highlighted in green in the image below). As you adjust the screw, rotating the set screw clockwise moves the hook out, while a counter-clockwise rotation with finger pressure on front of hook moves it backwards. Adjust until the gap between the needle and hook point is 0.1mm (.004”).

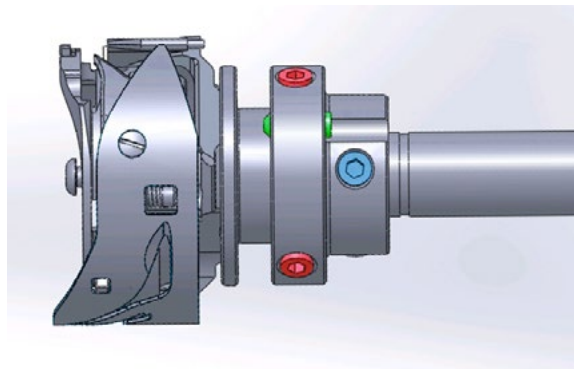

12. Lightly tighten each of the three Hook Fastening Screws before fully tightening them. Press and hold the Adjustment key, then press the Right Arrow key to provide access to the screws if needed.

BERNINA

13. Repeat step 11 and verify hook gap did not change. Repeat steps 9-13 if hook gap is larger than 0.1mm (.004").
14. You have verified that both the needle to hook gap and the rotational hook timing are correct, refer to the Rotary Hook Support Adjustment section of this document to finish adjusting the rotary hook.

Thread Clamp Replacement

1. Disconnect the A/C power input cord and the external Ethernet cable from the back of the machine.
2. Remove needle plate
3. Loosen lower arm extrusion cover (4 M3 cap head screws, 2 on the right and 2 on the left) and remove cover

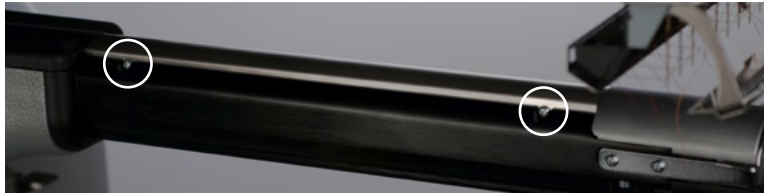

4. Remove lower arm casting top cover (4 M4 socket head cap screws)



5. Disconnect the thread clamp solenoid assembly harness
6. Remove the thread clamp assembly mounting screw (M3 cap screw)



7. Remove thread clamp assembly
8. Follow steps 2-6 in reverse order for installation

Thread Clamp PCB Replacement

1. Disconnect the A/C power input cord and the external Ethernet cable from the back of the machine.
2. Remove lower arm rear cover (7 M4 Socket head cap screws)

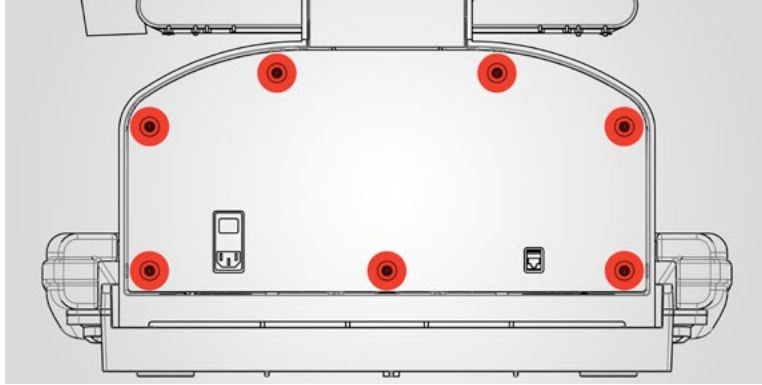

3. Disconnect the 3 harnesses from the thread clamp PCB and remove the thread clamp PCB (4 M3 button head cap screws)

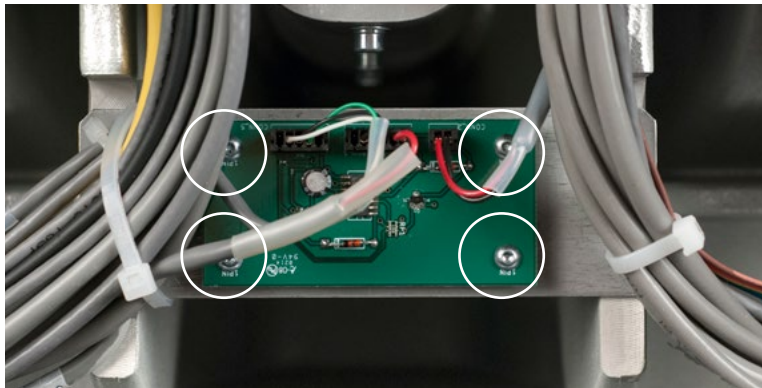

4. Install the new thread clamp PCB following previous steps in reverse order

Thread Clamp Harness Replacement

1. Disconnect the A/C power input cord and the external Ethernet cable from the back of the machine.
2. Loosen lower arm extrusion cover (4 M3 cap head screws, 2 on the right and 2 on the left) and remove cover

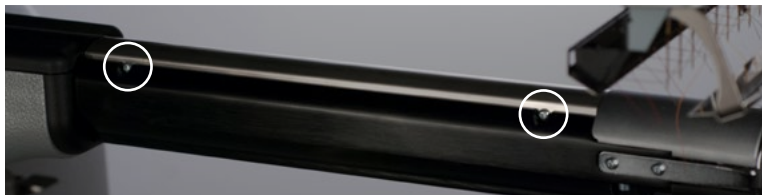

3. Remove lower arm casting top cover (4 M4 socket head cap screws)

BERNINA



4. Disconnect the thread clamp solenoid assembly harness
5. Remove lower arm rear cover (7 M4 Socket head cap screws)

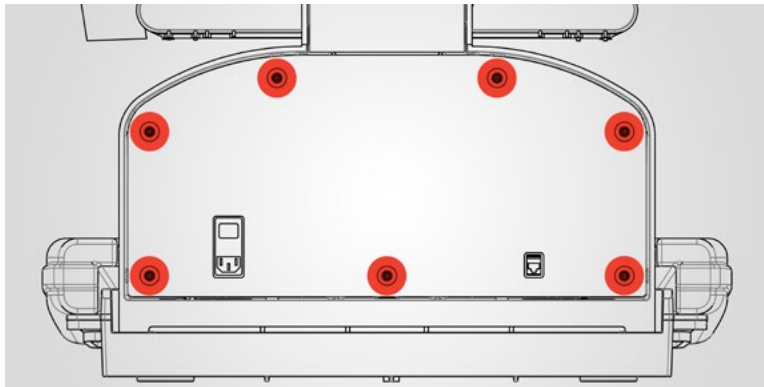

6. Disconnect the thread clamp harness from the thread clamp PCB

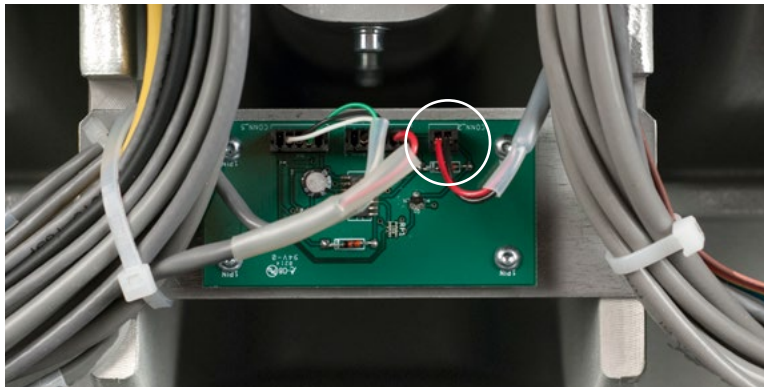

7. Install the new thread clamp harness following previous steps in reverse order

BERNINA

Laser Light - Adjustment

 **WARNING!!** This procedure is intended to be performed only by specially trained and authorized service technicians and personnel. Disassembly by untrained individuals will void any warranty protection and can result in personal injury or damage to the machine.

 **WARNING!!** DO NOT allow the laser beam to be aimed at yours or anyone else's eyes. The laser emits a very concentrated light beam that can cause permanent blindness. Use extreme care in handling the laser assembly to make sure it is not going to be inadvertently aimed at someone's eyes or face. DO NOT LOOK DIRECTLY AT THE LASER LENS WHILE IT IS ENERGIZED!

1. Before performing this procedure, ensure that:
 - The work area has been cleared of unauthorized personnel to prevent inadvertent exposure to the laser light.
 - The laser light is pointed away from any person in the area.
 - Everyone is cautioned to stay out of the path of the laser light.
2. Remove the laser assembly from the machine using the procedures provided in Laser Pointer Assembly.
3. TURN THE MACHINE OFF.



 **CAUTION!!** DO NOT allow the laser housing to touch any part of the machine. If that should happen, the laser will be damaged and will have to be replaced.

4. Secure the laser housing on a work surface using nonconductive clamps or devices (just secure enough to hold the laser in position).

 **WARNING!!** DO NOT LOOK DIRECTLY AT THE LASER LIGHT WHILE IT IS ENERGIZED!! Doing so will cause temporary blindness and can permanently damage your eyes. Exposure to laser light sources will very quickly damage eyes.

5. Connect the laser harness to the machine (if not already connected) and turn the machine ON.

BERNINA



Figure 2 - Laser Light Focus

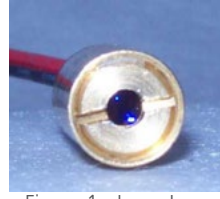

Figure 1 - Laser Lens

6. Adjust the focus of the laser light by aiming it at a wall or a similar flat surface about from a distance of about 10 feet and using a screw driver to adjust the size of the reflected light on the wall. **DO NOT** look directly at the laser light source while it is energized!!
 - a. To tighten the focus of the laser beam, turn the lens clockwise.
 - b. To loosen the focus of the laser beam (make the dot bigger, less concentrated), turn the lens counter-clockwise.



CAUTION!! *DO NOT over tighten or loosen the laser lens too far or you will damage the internal components.*

7. When the laser is adjusted properly, turn the machine OFF.



WARNING!! *DO NOT proceed past this step until the machine is turned OFF!!! Failure to turn the machine off may result in personal injury or damage to the machine.*

8. Install the laser assembly using the procedures provided in Laser Pointer Assembly section.

Needle Depth

The needle depth should be set after any of the following:

- replacement of any of the needle bars or needlecase assembly four-packs
- disassembly of the needlecase assembly
- when diagnostic tests determine resetting of needle depth is necessary

To set the needle depth, the software must be launched and the machine must be turned on. Refer to the following procedures to set the needle depth.

Setting the Needle Depth by Eye

1. Click the Maintenance menu on the BERNINA E16 OS main menu screen, and then click the Head Timing tab to open up the Head Timing menu.
2. Remove the bobbin case and bobbin (if installed) and then click the Head Up button and then color change left to Needle 1.
3. Click on the Bottom Center button.
4. Look directly into the hook assembly and check the location of the needle's eye compared to the figure above. 1/2 of the through portion (the portion that you can see through) of the needle eye should be visible in the hook assembly. If the needle's eye is in the acceptable range, skip the next few steps and go to Step 7. If the needle's eye is not in the acceptable range, continue this procedure with the next step.
5. Loosen the set screw on the needle bar drive stud and move the needle bar up or down until needle depth is correct. (1/2 of the needle eye through portion should be visible) Repeat step 4 above and repeat this step again if the needle depth is not correct.
6. Click the Head Up button and then the Bottom Center button and check that the needle is at the proper needle depth position. If it is not, go to step 5 above.
7. Click on Head Up. Color change to the next color.
8. Repeat steps 3 through 7 until needle depth is set on all 16 needles.
9. Reinstall the bobbin and bobbin case.
10. Run the following test designs on the machine:
 - AMTBTESTXXX.EXP (Thread Break Test)
 - AMRTESTXXX.EXP (Looping Test)



Figure 1 - Head Timing Menu

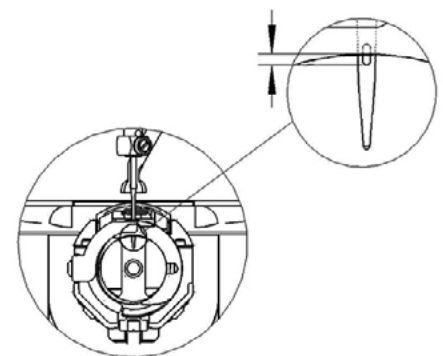

Figure 2 - Needle Depth

Presser Foot Height

To adjust the presser foot height, the machine must be turned on and BERNINA E16 OS must be launched. A hoop with fabric must also be installed. You can set the presser foot height in the middle of a design.

If you set the presser foot height over a sewn section of the design, set the presser foot so it barely touches the stitching.

If you set the presser foot height over a bare section (unsewn) of the fabric, set the presser foot so that it comes close to the fabric but does not touch it (leave a gap between the fabric and the presser foot roughly equal to the thickness of the thread). Always set your presser foot to allow for the highest point in the design. You can adjust the presser foot height at anytime in the design as long as the machine is stopped and the current needle is taken to bottom dead center.

Presser foot height may vary slightly with each machine and with each operator. It will be dependent on many variables such as thread type and thickness, fabric, needles, and operator preference. The ideal setting on presser foot height is so that the presser foot just touches the fabric at the point where the needle begins the upstroke (it starts to move back up).

1. Click the Bottom Center button in the Head Timing tab to take the needle to bottom dead center.
2. Use the presser foot adjustment eccentric located behind the needlecase and adjust the presser foot height up or down as needed. It is recommended that the presser foot is set at this point to where it just touches the fabric.
3. Click the Head Up button in the software Head Timing menu. Close the Maintenance menu screen in the software by clicking on the OK button (Figure 1).

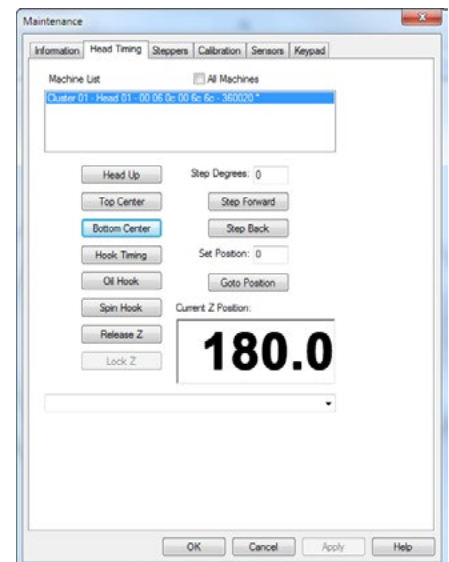

Figure 1 - Presser Foot Height



Figure 2 - Presser Foot Height Adjustment Eccentric

X/Y Home Adjustment

Setting X/Y home requires the use of the X/Y Home Fixture (PN: 30873). The use of this fixture is strongly recommended as it provides for consistent accuracy in the home settings.

Home Adjustment Procedures:

1. Turn the machine ON.
2. Engage the emergency stop by pushing the e-stop button in.



CAUTION!! Use extreme care not to drop metallic objects, tools, or other conductive material on the Main PCB when you have the base cover removed. If you drop such objects on the Main PCB, it can severely damage the electronics which will be very expensive to repair.

3. Remove the base cover.
4. Remove the EMI cover by carefully removing the screw.

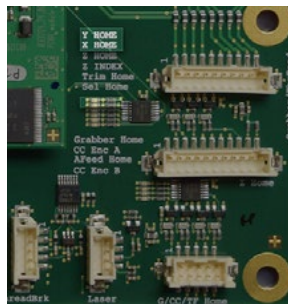

Figure 1 - X- and Y-Home LEDs

5. Being careful not to touch the main PCB while it is powered up, locate the X and Y-Home LEDs. You will need to observe whether these LEDs are on or off while setting home. Home for these LEDs is set correctly right at the point where these LEDs are brightly illuminated (not dim or off).
6. Remove the left arm cover.



Figure 2 - X/Y-Home Fixture in Needle Plate Hole

7. Install the X/Y-home fixture onto the x-carriage at the third screw hole from both ends so that the fixture is centered on the x-carriage.
8. Align the fixture pin over the needle plate hole and push the front of the fixture down until the pin on the bottom of the fixture front block is firmly seated in the needle plate hole as shown in Figure 2 above.

BERNINA

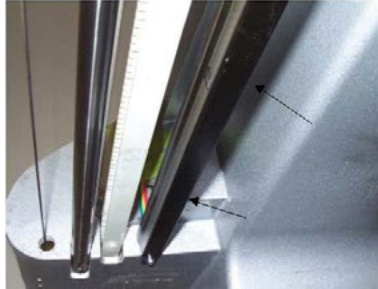

Figure 3 - Y-Home Flag (Bottom View)

9. Loosen the screws mounting the Y-Home Flag to the bottom of the upper arm body on the left side. The Y-home flag also serves as a wiring channel for the X/Y home harness (the rainbow colored ribbon cable).
10. Move the Y-Home flag all the way to the front to a dead stop, then slowly move the y-home flag towards the back just until the LED comes on and is brightly illuminated. Tighten the screws to the Torque Specifications as listed in that section.

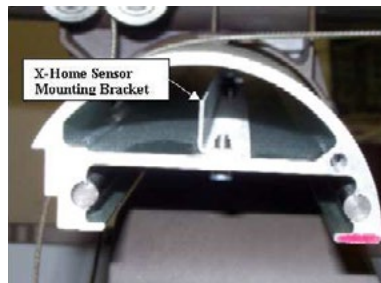

Figure 4 - X-Home Sensor Mounting Bracket

11. Loosen the two screws that mount the x-home sensor mounting bracket inside the x-beam. Move the mounting bracket all the way to the left end of the beam and then push it back in to the right just until the X-home LED comes on. Tighten the screws back to The torque specifications.
12. Move the x-beam all the way to the back to a dead stop, observing the centering of the y-home flag in between the sensors on the X/Y home PCB. Stop if the beam starts to hit one of the sensors. If needed, loosen the screws on the Y-Home flag and center the flag between the optical sensors. Move the x-beam all the way to the front to a dead stop and repeat the procedure at the front. Move the beam back and forth a few times and make sure that the optical sensors on the bottom of the X/Y home PCB do not hit the Y-home flag and the flag is approximately centered on the flag.



CAUTION!! DO NOT release the E-Stop Button while the Y-Home Fixture is installed on the machine. Severe damage to the machine can occur if you release the E-Stop Button or attempt to operate the machine with the fixture in place.

13. Remove the X/Y-home fixture first and then release the emergency stop button by turning left or right to release it.

BERNINA

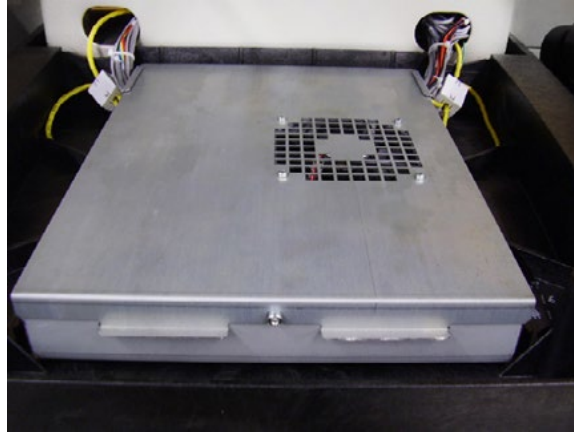

Figure 5 - 33322 Series EMI Cover

14. Install the EMI Cover carefully.
15. Install the base cover.

X-Cable Tension

The following instructions will guide you through checking and, if necessary, adjusting the X-Cable tension on your machine. The X-Cable Tension Gauge (PN 33909), shown in picture 1 below, is used to indicate the permissible range for proper X-Cable tension.



Figure 1: X-Cable Tension Gauge, PN 33909

Determining if an X-Cable is Set to Required Specifications

1. Remove the right Side Cover shown in picture 2 below. Using a 4mm bent Allen wrench, remove the three indicated screws and carefully remove the Side Cover.



Figure 2: Removing the right cover

2. Center the Y Belt Clamp between the two black indicator marks on the Y Belt, as shown in picture 3 below, by moving the X-Beam forward or back.

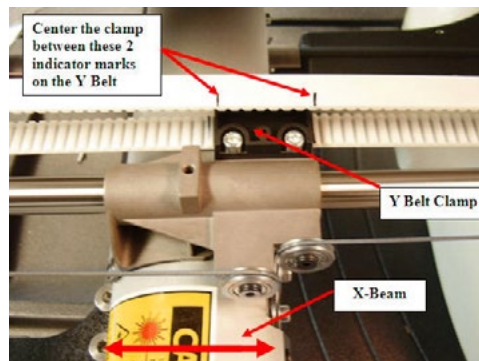

Figure 3: Centering the X-Beam

3. Move the X-Carriage left or right until the two screws indicated in picture 4 below are centered to the Lower Arm.

BERNINA

4. Position the X-Cable Tension Gauge on the X-Cable as shown in picture 5 below. Center the Gauge between the indicated Pulley and the Upper Arm.

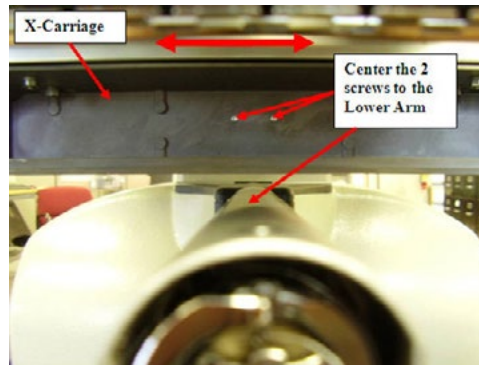

Figure 4: Centering the X-Carriage

5. A properly adjusted X-Cable will fall within the cutout area shown in picture 6 below. If the X cable falls within the cutout area, remove the fixture and re-install the Side Cover.



Figure 5: Positioning the X-Cable Tension Gauge

6. An improperly adjusted X-Cable will be positioned outside, either above (tension too low) or below (tension too high), the cutout area as shown in pictures 7 and 8 below. In this case the tension of the X-Cable requires adjustment. Follow steps 1-5 in the section below to properly adjust the tension of the X-Cable.

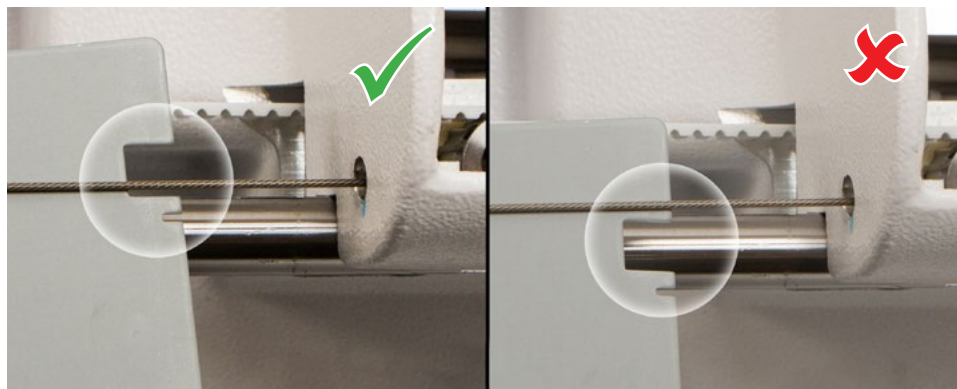

Figure 6: Inspecting X-Cable Tension

Adjusting an X-Cable that is Tensioned Outside the Required Specifications

1. Locate the M4 Nut and the X-Cable Stud at the end of the X-Cable where it mounts to the front of the Upper Arm as shown in figure 8 below.



Figure 7:X-Cable Tension Adjustment

2. Using a small wrench grip the M4 Nut (shown in picture 7 above) and with a pair of pliers or crescent wrench grip the X-Cable Stud at the end of the X-Cable as shown in picture above.
 - Pay attention to the threads of the threaded end of the cable to rotate the M4 Nut to tighten or loosen the X-Cable tension.
3. Remove the tools and gauge.
4. Move the X-Beam full travel to the front and back and the X-Carriage full travel left and right a few times to ensure proper settling of the X-Cable tension.
5. Repeat steps 2 – 5 in the “Determining if an X-Cable is Set to Required Specifications” section and verify that the X-Cable is now adjusted to required specifications. If the X-Cable tension is adjusted properly, remove the fixture and re-install the Side Cover. If the X-Cable tension is still not adjusted properly, repeat steps 1-4 in “Adjusting an X-Cable that is Tensioned Outside the Required Specifications” section until the X-Cable tension is adjusted correctly.

Adjusting the Tension on a Replacement X-Cable

1. If a new X-Cable had to be installed on the machine, the initial X-Cable tension adjustment should align the X-Cable with the smaller cutout area just below the main tension cutout on the X-Cable Tension Gauge.
2. Follow steps 1-4 in the “Determining if an X-Cable is Set to Required Specifications” section above to properly position the X-Cable Tension Gauge on the X-Cable.
3. Follow steps 1-3 in the “Adjusting an X-Cable that is Tensioned Outside the Required Specifications” section above to adjust the tension in the X-Cable until the X-Cable aligns with the small cut out in the X-Cable Tension Gauge as shown in picture 12 below.
4. After initial adjustment of the tension in the new X-Cable the X-Cable will stretch (= X-Cable tension will decrease) to a point where the X-Cable will fall within the required operating range as shown in picture 6.

Y-Axis Timing Belt Tensioning

The Y-axis timing belt tensioning requires that the machine is turned off while measuring the tensions. This procedure can be performed by the machine operator as long as the following procedures are followed explicitly.

This procedure requires the use of a 0-10 lb. Force Gauge, a Universal Force Gauge Adapter, Y-Belt Tensioning Fixture, a 3mm Hex wrench, and a 7mm nut driver.

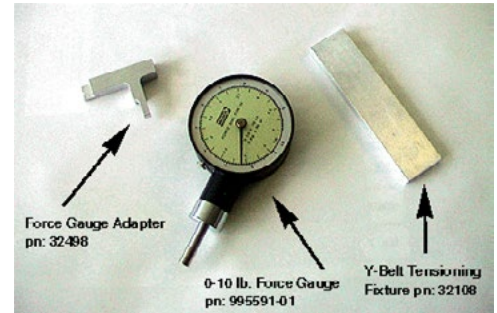

CAUTION!! DO NOT over tension timing belts. If you do, the belts will stretch excessively and might cause heavy internal damage to the machine.

Y-Axis Belt Tension Inspection

1. Attach the Universal Force Gauge Adapter, PN 32498, to the 0-10 lb. Force Gauge, PN 995591-01 (screw adapter on the end of the gauge).
2. Remove the left and right covers (use 3mm hex wrench to remove screws).

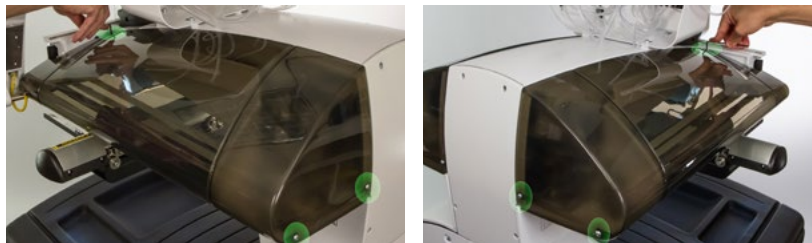

3. Move the x-beam all the way to the front of the machine until it comes to a dead stop.



Figure 1 - X-Beam Position

4. Center the Y-belt tensioning fixture on top of the lower y-belt (see Figure 2).

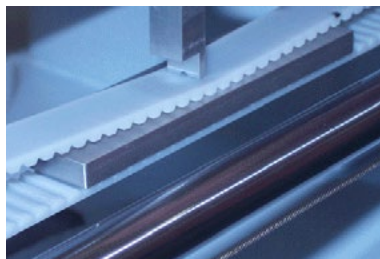

Figure 2 - Checking Force

BERNINA

5. Push the force gauge (attached to adapter) down on the upper y-belt until the belt touches the Y-belt tensioning fixture. The force should read 8.1 ± 0.3 lbs.
6. Repeat steps 4 and 5 for the other side of the machine. If the belt tension on either side needs to be adjusted, proceed to the adjustment procedure.

 *Note: If a BRECO meter is used to measure the tension, the measurement should be 45-50 Hz.*

Y-Axis Belt Tension Adjustment

Procedure for Y-belt on left or right side of machine

1. Turn the machine OFF.
2. Move the x-beam back and forth a few times, bring it to the front to a dead stop, then adjust the tension up or down at the tension adjusting screws indicated in the image below. To increase the tension, turn both adjusting screws clockwise by the same amount. To decrease the belt tension turn both adjusting screws counterclockwise by the same amount.



Figure 3 - Y-Drive Timing Belt Adjusting Screws

When Belt Tensions are Correct

1. Reinstall the left and right arm covers.
2. Do a short machine functional test and observe correct y-axis movements. If the belts travel on the idler pulley off-center to the left or right, readjust the tension starting at the beginning of this section.

Y-Motor Timing Belt Tensioning

 *This repair requires timing and other adjustments and must be done by an authorized service technician.*

This procedure requires the use of a Force Gauge and a Universal Force Gauge Adapter.

Inspection and Adjustment

1. Attach the Universal Force Gauge Adapter, PN 32498, to the 0-10 lb. Force Gauge, PN 995591-01 (screw adapter on the end of the gauge).
2. Remove the right upper arm cover, the back screw of the left upper arm cover and the upper arm rear cover.
3. Using a ruler (preferably metric) mark the casting at 25mm (1") above the machined edge that is to the left of the y-motor belt (this is shown in the following image).



4. Align the lower face of the adapter (with gauge attached) with the mark on the casting, positioning the tip of the adapter on the y-motor belt (see the following image).



5. Push the force gauge toward the machine until the flat portion of the adapter just touches the casting. The force should be between 7.5 and 9.5 lbs.
6. If the tension measurement is not correct, loosen the three cap head socket screws that mount the y-motor mounting bracket to the upper arm body.
7. Increase or decrease the y-motor mounting bracket and tighten the upper two screws.
8. Measure the tension again. If the tension is still not correct, repeat steps 6 and 7 again but applying more or less force on the motor.
9. When the tension is correct, tighten all three cap head socket screws mounting the y-motor bracket to the upper arm body to Torque Specifications.
10. Reinstall the upper arm rear cover and the right upper arm cover.
11. Run the following designs to verify belt tensioning and registration:
 - AMBTSTXXX.EXP (Belt tension test)
 - AMRTESTXXX.EXP (Registration test)

Z-TIMING: Bottom Center & Head-Up

Tools Required

- Head Timing Dial Indicator Gauge and gauge pin (PN: 32453-01)
- #75 (3mm) hex driver or equivalent bent Allen wrench
- 3lb weight
- Head Timing Adaptor (PN: 33065)

Abstract

The Z-flag is manually adjusted such that a Bottom Center command initiated either by the keypad or software will generate the lowest possible mechanical position of a corresponding needle at $180^{\circ} \pm 0.5^{\circ}$ z-axis position (displayed in the BERNINA E16 Operating System (OS) Maintenance > Head Timing" menu).

Bottom Center (Z Timing)

Measurement

1. Color change to needle #9.

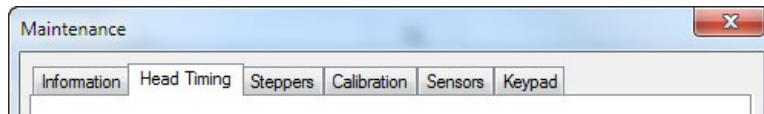

Figure 1 - Tools>Maintenance>Head Timing Menu

2. Open the Maintenance Menu, then click the Head Timing tab.
3. Remove the bobbin case and the needle plate.
4. Assemble the Head Timing Adaptor (PN: 33065) to the dial indicator (PN: 32453-01) as shown in Figure 2.

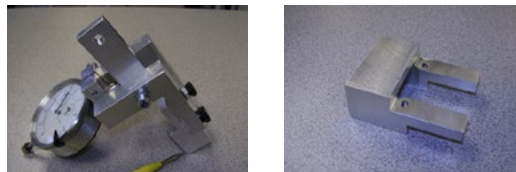

Figure 2 - Adaptor and Dial Indicator

5. Install the dial indicator (PN: 32453-01) and Head Timing Adaptor (PN: 33065) on the lower arm extrusion as shown in Figure 3. Tighten the screws enough to hold the fixture securely.



Figure 3 - Dial Indicator and Adaptor Installed on Lower Arm Extrusion

6. Cycle the machine to its Bottom Center position by pressing the Adjustment and Arrow Down keys simultaneously on the keypad (be careful not to let the needle "slam" against the indicator plunger because this may cause damage).
7. With the indicator plunger in full contact with the needle, hang the 3 lb weight from the needle clamp as shown in Figure 4. Be sure its path is unrestricted and not touching the plunger.

i **NOTE:** *The weight must be attached before needle depth.*



Figure 4 - Needle Clamp and Weight

8. Decrease the angular position by at least 0.004" from the bottom dead center position using the Hoop command.
9. Using the micro-stepping command (Trace and Arrow Down keys), increase the angular position until the dial indicator needle stops moving (= "Z Lower Dwell Start"). Continue to increase in angular position; all the while there should be no movement through 179.5 ° - 180.5 °.
10. Increase the angular position to the point where the needle starts to rise (= "Z Lower Dwell Stop").
11. Continue to increase the angular position until 0.001" rise (= "Z 0.001" Rise") is measured. The corresponding angular position at this point should be 182.5± 0.5°. If not, z-timing has to be reset.

Adjustment

1. Color change to needle #9.
2. Open the Maintenance Menu, then click the Head Timing tab.

BERNINA

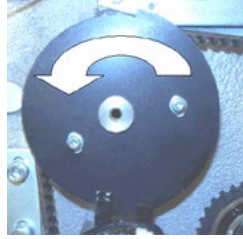

Figure 3 - Turn Z-Axis Flag Counter-Clockwise (CCW)

3. At the rear of the machine, loosen the z-axis flag; and while facing the z-axis flag, rotate it completely counter-clockwise and re-tighten it. See Figure 3.

i *Note: If the machine loses power after this step, it will be necessary to “roughly” reset z-timing. Do so by following the steps outlined below. Otherwise, proceed to step 12.*

4. Shut the machine off.
5. Engage the E-Stop button on the user interface.
6. Turn the machine on and let the system (machine and software) boot up.
7. Manually move the z-axis to its upper most position (upper dead center).
8. Loosen the z-flag at the back of the machine.
9. Rotate the z-flag back and forth to the point where the Z-Index LED is triggered.
10. Tighten the z-flag at this transition point.
11. Reboot the machine.
12. Cycle the machine to Head-Up at least three times by pressing the Adjustment and Arrow Upkeys simultaneously on the keypad.

i **NOTE:** *Weight must be attached before needle depth.*

13. Install the dial indicator (PN: 32453-01) with the adaptor (PN: 33065) on the lower arm extrusion as shown in Figure 4. Tighten the screws enough to hold the fixture securely.



Figure 4 - Dial Indicator Installed on Needle Plate Bracket

14. Cycle the machine to its Bottom Center position by pressing the Adjustment and Arrow Downkeys simultaneously on the keypad. (Be careful not to let the needle “slam” against the indicator plunger because this may cause damage).

BERNINA

15. With the indicator plunger in full contact with the needle, hang the 3 lb weight from the needle clamp as shown in Figure 4 above. Be sure its path is unrestricted and not touching the plunger.
16. In the Head Timing window, go to Needle Depth (bottom center) Release Z and manually rotate the z-shaft back and forth as necessary to approximately locate the lowest mechanical position on the dial indicator. The needle will be at it's lowest point right before it begins to rise.
17. Use the micro-step command on the keypad to decrease (press the Trace key and the Arrow Down key) the angular position until the needle begins to rise and continue doing so for 0.003" more.
18. Using the micro-step command on the keypad, increase (press the Trace key and the Arrow Down key) the angular position back to the lowest needle position. After the needle stops moving, note the angular position and continue to micro-step in the same direction for at least 1.5 ° more; the needle should not move.
19. Verify that the dial indicator is zeroed. If it is not on zero, reset the dial indicator to zero.
20. Increase the angular position by micro-stepping until the dial indicator registers a needle bar rise of 0.001". Record the angular readout at this height and include all decimal places (Θ).
21. Important: Add 177.5 ° to the angle from the previous step ($\Theta + 177.5$) = β z-index setting (include all decimal places). The sum should not be greater than 360 ° ! If it is, then make sure the z-flag was rotated fully counter-clockwise. If it wasn't, repeat the procedure from step 15 forward.
22. Using the Step Forward command in the Head Timing tab, increase the angular position by 2 ° increments until the gauge pin clears the dial indicator plunger. After that, support the weight step upward in 5 ° increments or more; stopping roughly 5 ° - 7 ° before reaching the β z-index setting position.
23. At this position, let the weight once again hang freely and use the micro-step command to slowly increase angular position to exactly β z-index setting.



Note: It is very important that you don't overshoot this value. If this happens, rotate back at least 5 ° before this point and repeat.

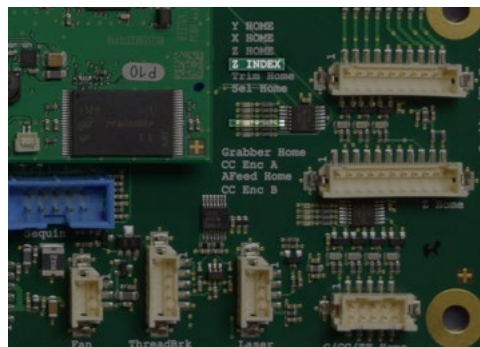

Figure 5 - Z-Index LED (Location D50)

24. Loosen the z-flag and manually rotate it until the z-index LED (located at D50 on the main PCB as shown in Figure 5 above) changes state. Carefully tighten the flag in place at this transition point with the LED light off.

BERNINA



Note: It is very important that the z-flag is set at a z-shaft angle equal to β z-index. The position may change slightly while the z-flag is tightened. If this happens, simply loosen the flag once more, and gently rotate the z-shaft at the rear pulley to re-establish the original angular position and repeat.

25. The LED must turn off/on at $\pm 0.2^\circ$ of β z-index setting. Use the micro-step command to rotate the z-shaft down in angular position by at least 2° , then forward again and note the angular position at which the z-index LED changes state. Again, this should be within $\pm 0.2^\circ$ of β z-index setting.
26. Remove the weight and cycle the machine to Head-Up at least 3 consecutive times (be sure the needle in the needle bar clears the dial indicator plunger during this step).
27. Cycle the machine to its Bottom Center position and replace the weight. (Be careful not to let the gauge pin "slam" against the indicator plunger because this may cause damage).
28. Decrease the angular position by at least $0.004''$ from this position.
29. Increase the angular position to the point where the needle starts to rise (= "Z Lower Dwell Stop").
30. Continue to increase the angular position until $0.001''$ rise (= "Z 0.001" Rise") is measured. The corresponding angular position at this point should be $182.5 \pm 0.5^\circ$. If not, repeat the procedure from the beginning.

BERNINA

Z-Drive Belt Tensioning

This procedure can be performed by the machine operator as long as the following procedures are followed explicitly.

This procedure requires the use of a 0-10 lb. Force Gauge and a Universal Force Gauge Adapter, a 3mm hex wrench.

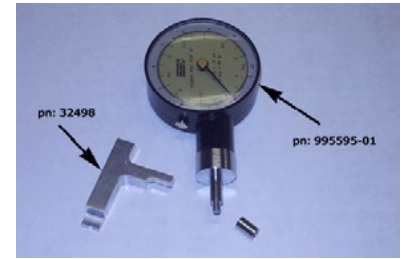

Inspection and Adjustment

1. Attach the Universal Force Gauge Adapter, PN 32498, to the 0-10 lb. Force Gauge, PN 995591-01 (screw adapter on the end of the gauge).
2. Turn the machine OFF.
3. Remove either one of the upper arm covers and the innermost back screw of the other one (remove screws with a 3mm hex wrench).

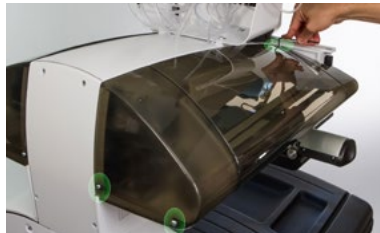

4. Remove the upper arm back cover (remove screws with a 3mm hex wrench).
5. Locate the z-drive belt and the z-motor mounting bracket.

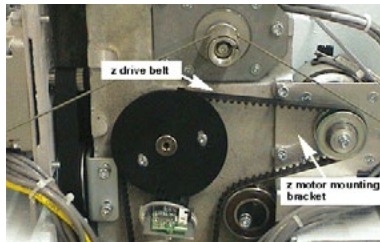

6. Using a ruler (preferably metric) mark the z-motor mounting bracket 17mm (0.67") below the top edge of the bracket.

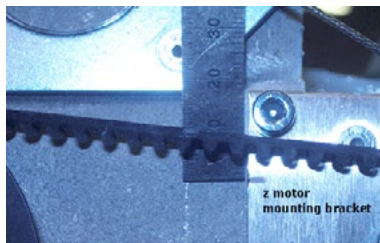

7. Position the gauge adapter (with gauge attached) as shown in the image below.

BERNINA

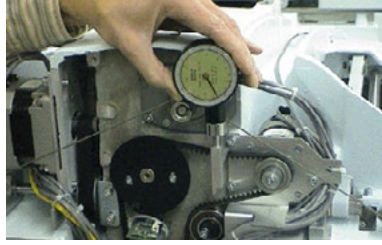

The right side of the adapter should be lined up with outside edge of the motor mounting bracket.

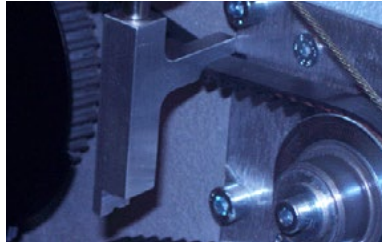

8. Push down on the force gauge until the top of the belt lines up with the mark on the mounting bracket. The force should be 6.8 ± 0.3 lbs.
9. To adjust the tension of the z-drive belt, hold the idler pulley steady with one hand and loosen the screw with a 3mm hex wrench. Turn the z-idler pulley clockwise to increase the tension (counter-clockwise to reduce tension) and then tighten the screw to the Torque Specifications.

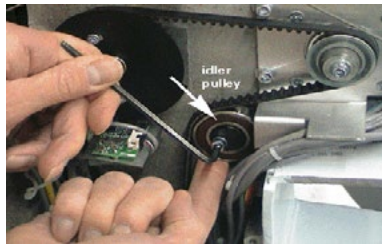

Measure the tension again (as specified in Steps 7 and 8) and if it is not correct, repeat step 9 until the tension is set to the specification.

10. Reinstall the covers in the reverse order that you removed them. Tighten the screws to The torque specifications.
11. Do a short machine functional test to verify proper z-axis timing (needle bars synchronized, with rotary hook movement).



Note: If a BRECO meter is used to measure the tension, the measurement should be 72-78 Hz.

Z-Home Adjustment

Align the z-home flag using procedures defined for “Head-Up Position Alignment”.

Procedure to Identify the Closest Needle

When the needle case has been replaced, it is necessary to reestablish the closest needle and make sure that it falls under the total allowable variance of .006. The following is the procedure to identify to the closest needle:

1. Perform the following procedure: Use the dial indicator from the take up lever stroke fixture (PN 32413), remove it, and attach it to your head timing gauge (PN 32453-01).
2. Assemble the head timing gauge (PN 32453-01) to the XT head timing adaptor (PN 33065) as shown in Figure 1.



Figure 1

3. Remove the needle plate (PN 33111).
4. Remove the bobbin case (PN 004267-01).
5. Mount the closest needle gauge fixture to the lower arm extrusion. It should appear as shown in Figure 2:



Figure 2

6. In the software, enter the Maintenance Menu.
7. Under the Maintenance Menu, enter the Head Timing Menu.
8. YOU MUST PULL OUT THE PLUNGER of the closest needle dial indicator and KEEP IT HELD OUT as you hit the Frame Back button on the keypad of your Machine machine. See Figure 3 for an example of holding the plunger back.



NOTE: If you exit the needle depth subroutine at any time, you need to close the Head Timing Menu in the software and reopen it to re-enter the needle depth subroutine. Press the frame back button while holding the plunger out to re-enter the measurement routine.

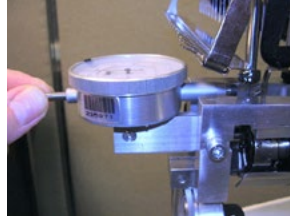

Figure 3



Note: You may also need to adjust the height of the closest needle measurement gauge so that the plunger touches the needle and NOT the needle clamp.



Figure 4

9. Zero your closest needle dial indicator on the first needle.
10. Pull the plunger away and be sure it goes to zero when it touches the needle. Zero the gauge again if needed.
11. Record the zero measurement under Needle 1 on the worksheet that is provided with this TAB. (See example of worksheet below.)
12. Pull the plunger back and hit the Frame Back button again. The machine changes to Needle 2 and goes to needle depth.
13. Record the measurement under Needle 2 on your worksheet. Anything on the left side of zero on the dial indicator is a negative number. Estimate to the closest quarter of a thousandth.
14. Repeat this process for each needle, recording each measurement on your worksheet.

BERNINA

Needle Number	Measurement
1	.000
2	-.002
3	.000
4	-.00125
5	-.00025
6	-.00025
7	.00025
8	.0005
9	.00075
10	-.005
11	-.00025
12	-.00375
13	-.00325
14	-.00425
15	-.001
16	-.00275

Example of a Completed Worksheet Table

15. The most negative number is your closest needle. If no negative numbers are recorded, then the needle with value '0' is the closest needle. Using the example above, the closest needle is Needle 14 with a measurement of -.00425.
16. Record this number on masking tape in the chasse, replacing the previous piece of tape with the closest needle measurements.
17. You need to calculate the total variance to be sure that it is within the total allowed variance of .006. You do this by adding the most positive number and the most negative number. Using the example above, you would add -.00425 to +.00075. You get .0035 and this is within the total allowed variance of .006. If your machine does not fall in this range, you can replace the needle bar in the closest needle (the most negative needle). If this does not work you need to replace the needle case assembly.
18. Return the machine to 'Head Up' by holding the plunger back and simultaneously pressing the Adjust and Up keys on your machine keypad.
19. Remove the Closest Needle fixture.
20. Replace the Bobbin Case.
21. Replace the Needle Plate.

Needle Case Calibration

This procedure is required whenever the needle case has been removed and re-installed. Calibrating the needle case requires a rough calibration and a fine calibration. The fine calibration is done with the Needle Plate removed and the needle is aligned to the Rotary Hook Center Post. The rough calibration is performed with the Needle Plate installed and the needle is aligned to the center of the needle hole.

Fine calibration procedure:

1. Make sure the BERNINA E16 OS is up on your computer screen and your machine is ON.
2. Remove the Bobbin Case Assembly and the Needle Plate.
3. In the BERNINA E16 OS, got to Tools>Maintenance as shown below.

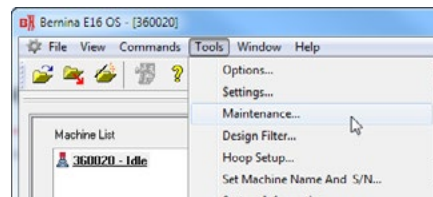

Figure 1: Maintenance Window

4. Next, click on the Steppers tab as shown below

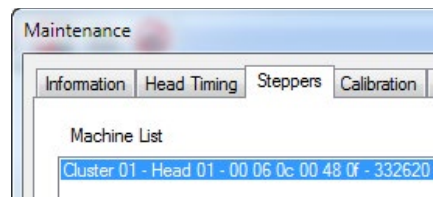

Figure 2: Steppers Tab

5. Next, click on the Color Change - Home button as shown below. This will move the needle case to the home position and finally come to rest at needle position 1.

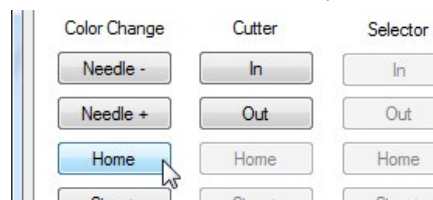

Figure 3: Color Change Home

6. Next, click on the Calibration tab as shown below.

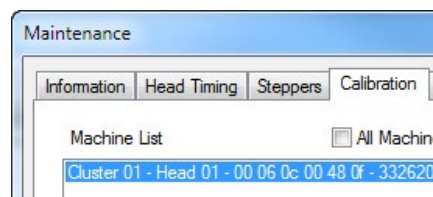

Figure 4: Calibration Tab

BERNINA

7. Lower the needle to the Needle Depth position by holding down the Adjust button and then pressing the Down Arrow.
8. Check to see where the needle is in relation to the rotary hook center post.
 - a. It will help to use a flashlight and/or magnifying glass.
 - b. It is also very critical that you observe the needle from directly in front of the hook. If you are looking from even a slight angle, it may cause you to incorrectly calibrate the needle position.
9. Determine how far to the left or the right the needle needs to be adjusted.
10. Move the needle to the Head Up position by holding down the Adjust button and pressing the Up Arrow.
11. Micro-step the needle the distance and direction determined in the previous observation step.
 - a. Micro-stepping is done by hitting the Trace button and the Left or Right arrow, depending on the intended direction.
12. Each time the arrow is pressed, the needle case moves 8 one-hundredths (0.08) of a millimeter which is equal to 0.003 inches.
13. Lower the needle to the Needle Depth position.
14. Observe the relationship of the needle to the rotary hook center post.
15. If further adjustments are necessary, repeat steps 7-13.
16. If the needle is centered exactly to the post then you may move to the next needle.
17. Using the Frame-Back key is the quickest way to get to the next needle in this situation. It will bring the needle to the Head Up position, move to the next needle, and bring that needle to the Needle Depth position.
18. From there, you can repeat Steps 7-13 as needed until all 16 needles have been centered.
19. Upon completion of the 16 needle calibrations, hit the "Get Table" key in the BERNINA E16 OS. By hitting this key, you will be storing a backup copy of the calibration table in the computer.

Rough Calibration Process:

1. Loosely install the Needle Plate.
2. Hit the Frame-Back key to go to needle position 1.
3. By hand, align the Needle Plate so that needle 1 is in the center of the needle hole. Then tighten both needle plate screws; being sure not to knock the Needle Plate out of alignment.
4. Hit the Frame-Back key to move to the next needle.
5. The machine will now be at Needle Depth with the next needle position ready to be calibrated. As was done in the fine calibration, observe the position of the needle and figure out how it needs to be adjusted in order to get it in the center of the needle hole. It may already be in alignment from the fine calibration in which case you may go to Step 8.

BERNINA

6. Move the machine to the Head Up position Micro-step the needle the distance and direction determined in the previous observation step.
7. Lower the needle to Needle Depth and check its position.
8. If further adjustment is needed, raise the machine to Head Up and repeat steps 5 thru 7.
9. If the needle is centered, hit the Frame-Back key and move to the next position.
10. Repeat this process for the remaining needles.
11. Upon completion of all 16 needles, hit the Get Table button in the BERNINA E16 OS as shown below.

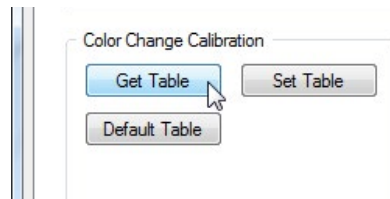

Figure 5: Get Table Button

12. Close out the Maintenance menu in the BERNINA E16 OS as shown below.

Rotary Hook Support Adjustment

The rotary hook support may need to be adjusted if a garment gets caught in the rotary hook, or if it is loosened. The proper adjustment of the rotary hook support is based on proper needle case calibration, please refer to the Needle Case Calibration procedure if necessary prior to completing the inspection.

Tools Needed:

- Hook Retaining Finger Gauge (PN: 009027-01) Thickness = 0.020". Tolerance = 0.002"
- 2mm Allen Wrench
- 2.5mm Allen Wrench for the needle plate.

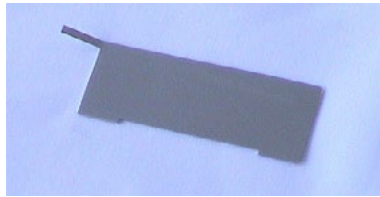

Figure 1 - Hook Retaining Finger Gauge

Inspection Procedure

1. Remove the bobbin case.
2. Remove the hook guard and needle plate.
 - a. Remove the hook guard by loosening the screws on both sides of the lower arm using a 2mm hex wrench, and sliding the hook guard forward. The screws do not need to be completely removed.



- b. Remove the 2.5mm Allen screws that secure the needle plate.



Figure 2 – Needle Plate Screws

3. In the BERNINA E16 OS, click on Maintenance Menu and then click the Head Timing Tab.

- Click the button labeled Bottom Center.



CAUTION: The needle will move without any on-screen prompting when you are in the Maintenance Menu.

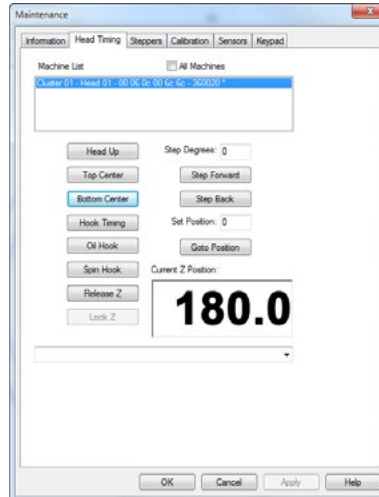

Figure 3 – Head Timing Tab

- Inspect the left-to-right position of the tip of the hook support (the portion of the hook support that is positioned inside the notch of the rotary hook – see Fig. 5) as it aligns to the needle. It should be centered left-to-right. If not, it may be necessary to bend the hook support to the correct alignment by hand (without tools), being careful not to scratch the highly polished surface. If this is not possible, you may need to replace the hook support (PN: 33046).

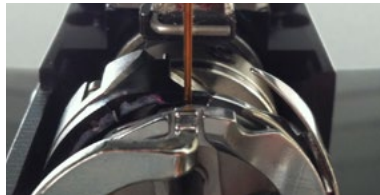

Figure 4 – Hook Support Position Left-to-Right

- Once the left-to-right position of the hook support is correct, click the Head Up button and then click OK.
- Insert the retaining finger gauge between the hook support and the hook basket.

BERNINA



CAUTION: If the gauge does not slide in easily, do not force it. You may scratch the highly polished surface of the hook support or hook basket, resulting in thread breaks.



Figure 5 – Retaining Finger Gauge Usage

The retaining finger gauge should slide between the hook support and hook basket with no resistance. The gap between the hook support and hook basket should be no more than 1.1 times the thickness of the gauge. (The gauge is 0.020" and the tolerance is ± 0.002 ".)

8. The tip of the hook support should be flush with the top of the hook basket.
9. If the adjustment is not correct, continue to the Adjustment Procedure below.

Adjustment Procedure



Note: Prior to adjustment, be sure to follow steps 1 through 9 in the Rotary Hook Support Inspection Procedure above.

1. Use the 2mm Allen wrench to loosen the 2 screws holding the hook support.



Figure 1 – Hook Support Screws

2. Position the hook support in the notch at the top of the rotary hook basket.



Figure 2 – Rotary Hook Basket Notch

3. Insert the gauge between the hook support and hook basket.

BERNINA

4. Holding the hook support from the side with the adjustment screws, adjust the position of the hook support to the requirements specified in the inspection procedure.
5. Remove the gauge while holding the position of the hook support, being careful not to scratch the highly polished surface (this is critical to proper operation).
6. Tighten the 2 screws holding the hook support.



Figure 3 – Hook Support Adjustment

7. Verify that the gauge still slides freely between the basket and hook support.
8. You may now reinstall the needle plate and bobbin case.

Color Change, Take-Up, Feeder Housing Assembly

The Color Change/Take-Up/Feeder Assembly is a sensitive component that should be repaired carefully following the procedures contained for each individual component. When repairing components on this assembly, do not loosen the screws that mount the housing to the upper arm body.

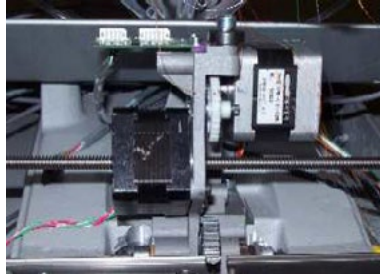

Figure 1 - Color Change/Take-Up/Feeder Housing Assembly

Do not attempt to repair or replace any component on the Color Change/Take-Up/Feeder Assembly except as provided by the below procedures:

- Color Change Linear Actuator Replacement
- Thread Feeder Gear Replacement
- Thread Feeder Optical Sensor Replacement
- Thread Feeder Radial Bearing Replacement
- Thread Feeder Stepper Motor Assembly Replacement



Figure 2 - Take-Up Lever Drive Gear Assembly



CAUTION!! Do not attempt to do any repairs or adjustment to the take-up lever drive gear, torsion spring or shaft. These components require a special fixture and specific training to adjust properly. If this component is tampered with, the entire Color Change/Take-Up/Feeder Assembly will have to be replaced.

Replacement Procedure for Entire Color Change/Take-Up/Feeder Assembly:

1. Color change to needle 1.
2. Remove the needlecase assembly.
3. Disconnect the motor and PCB harnesses.
4. Use a marking pen and trace the outline of the base of the Color Change/Take-Up/Feeder Assembly on the upper arm body.

BERNINA

5. Remove the Color Change/Take-Up/Feeder Assembly by removing the three cap head screws mounting it to the upper arm assembly.
6. Measure the amount of the color change shaft that extends from the left side of the old color change motor.
7. Turn the color change spindle on the replacement assembly until it is the same as the replacement assembly.
8. Mount the replacement Color Change/Take-Up/Feeder Assembly to the upper arm body loosely.
9. Align the base of the Color Change/Take-Up/Feeder Assembly to the outline traced on the upper arm body from the old assembly and tighten the screws to The torque specifications.
10. Install the needlecase assembly.
11. Check and adjust the needlecase alignment as necessary using the procedures specified in "Needlecase Alignment Procedures".

Color Change Linear Actuator Replacement

The color change linear actuator will show obvious signs such as overheating or electrical burn when it needs to be replaced in the majority of situations. However, signs such as uneven or “jumpy” movement noticed when turning the actuator shaft by hand or other troubleshooting tests that indicate that the actuator has failed are other situations in which replacement is appropriate.

i *This repair requires timing and other adjustments and can only be done by an authorized service technician.*

Replacement Part Needed:

- Actuator, Linear, Color Change

Replacement Procedures:



Figure 1 - Color Change Linear Actuator

i *Note: If you do not have the ability to color change because the motor has failed electrically or because of a mechanical failure go to Step 2.*

1. Color change to needle #8.
2. Turn the machine OFF.
3. Remove the needle bar access cover, the needlecase cover, and the color change covers..
4. Disconnect the color change stepper motor harness.
5. Loosen the screw on both the right and left spindle bracket that clamps the spindle.



Figure 2 - Right Color Change Spindle Mounting Bracket

6. Remove the two screws mounting the right color change spindle mounting bracket to the needle case. Remove the right color change spindle mounting bracket from the spindle.

BERNINA



CAUTION: Do not remove the spindle from the motor as this will cause the anti-backlash nut to spring off.



Figure 3 - Anti-backlash nut



Figure 4 - Left Color Change Spindle Mounting Bracket

7. Move the needlecase assembly by hand to the left until the spindle is freed from the left color change mounting bracket.
8. Remove the 3 motor mounting screws and remove the color change stepper motor from the color change housing.
9. Loosen (do not remove) the two screws that mount the left color change spindle mounting bracket to the needlecase.
10. Install the replacement color change stepper motor onto the housing making sure that the wires coming out of the motor face the back of the machine and down as shown in Figure 1.
11. Re-tighten the 3 motor mounting screws.
12. Turn the spindle clockwise and insert the left end of the spindle into the left spindle mounting bracket until the threaded portion of the spindle is flush against the bracket.
13. Tighten the screw that clamps the bracket to the spindle.
14. Mount the right color change spindle mounting bracket to the needlecase. Tighten the clamping screw. Leave the screws that mount the bracket to the needlecase loose.
15. Connect the color change motor harness to the motor.
16. Turn the machine ON.
17. Color change to Needle 16, tighten the two screws on the left color change spindle mounting bracket.
18. Color change to Needle 1 and tighten the two screws on the right color change spindle mounting bracket.
19. Check for free movement of the color change from Needle 16 to Needle 1.

BERNINA

20. If any noticeable binding occurs, repeat steps 18-20 until color changing from Needle 1 to Needle 16 and back is smooth and consistent.
21. Install the needlecase cover and access cover, and color change covers.
22. Run a short functional test using the test design AMPASSXXX with the machine in the unthreaded mode. Visually observe the color change functions and make sure everything was properly installed and adjusted. It is only necessary to run the machine through all 16 needles, then the functional test can be stopped as long as everything is correct.
23. Run test design AMTTTESTXXX to test color change functions.

Thread Feeder Gear Replacement

 *This repair requires timing and other adjustments and can only be done by an authorized service technician.*

The thread feeder gear will need replaced only when the teeth on the plastic gear are broken or worn excessively. It is important that you apply lubricant to the gear after you install a new one. Always install new retaining ring when replacing the thread feeder gear.

Replacement parts needed:

- P/N 34178 Gear, Thread Feeder, Z=28, M=1mm
- P/N 10454-08Ring, Retaining, External, 5mm Shaft (always use a new retaining ring)
- P/N 30853-08 Washer, S/S, 5.1mm ID X 8.3mm OD
- P/N 32205 Feeder Drive Gear Shaft Tool

Replacement Procedures:



Figure 1 - Thread Feeder Gear

1. Color change to needle #1 and turn the machine OFF.
2. Remove the Right Color Change Cover, P/N 33093.
3. Position the socket of the tool so that it engages the end of the Feeder Drive Gear Shaft. See

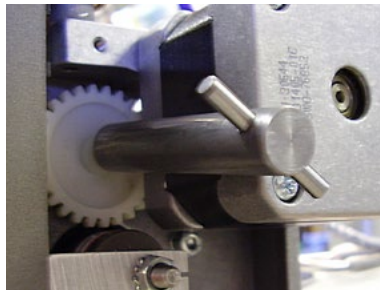

Figure 2.

4. Unscrew the Feeder Drive Gear Shaft and gear assembly and carefully remove it from the machine.

BERNINA

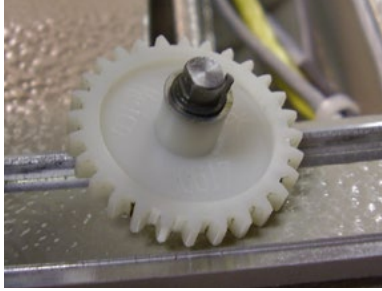

Figure 3.

5. Remove the retaining ring, washer and broken gear from shaft.
6. Assemble the new gear and re-install the washer and retaining ring.
7. Apply #222 Loctite to the threads of the Feeder Drive Gear Shaft.
8. Using the tool, carefully thread the shaft back into the drive base making sure the gear teeth are aligned with the gear on the Thread Feeder Assembly.
9. Using the T-handle on the tool, finger tighten (using tips of thumb and forefinger only) the shaft only.

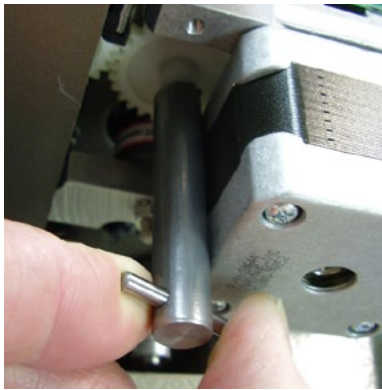

Figure 4.

10. Replace the Color Change Cover to complete the instructions.

Thread Feeder Optical Sensor PCB Replacement

The thread feeder optical sensor PCB requires replacement when the sensors are damaged due to improper installation or the sensors become so dirty that they cease to function correctly. It is not expected that the circuitry on the PCB itself will fail.

Replacement Parts Needed:

- P/N 31292 optical sensor PCB
- P/N 010170-08 two M3x0.5x6mm button head screws (recommend screws be replaced)

Replacement Procedure:

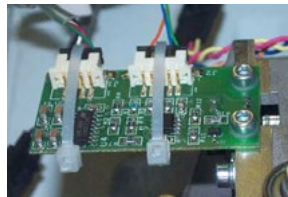

Figure 1 - Thread Feeder Assembly

1. Color change to needle 16.
2. Turn the machine off.
3. Remove the left color change cover.
4. Cut the cable ties and disconnect the harnesses from the PCB.
5. Use a marker and scribe a line onto the housing around the thread feeder PCB, then remove the PCB.
6. Remove the M3 screws from the PCB. Throw the old M3 screws away.
7. Apply red loctite (MS 222) to the replacement screw threads and install the replacement PCB on the color change housing loose.
8. Align the sensor so that the thread feeder flag is centered in the optical sensor and tighten the screws to the torque specifications.
9. Reconnect the harnesses to the PCB.
10. Use small plastic cable ties and tie the connectors snug by attaching the cable tie around the PCB such that the cable tie holds the connector in place. Failure to do this might result in the connectors coming loose which can create difficulties in troubleshooting. (See Figure 1.)
11. Turn on the machine.
12. If the thread feed gears do not mesh cleanly and quietly with the thread feed drive gear during color change, adjust the position of the PCB.
13. Reinstall the left color change cover.

Thread Feeder Radial Bearing Replacement

The thread feeder radial bearing will have obvious defects when it requires replacement. The radial bearings inside will develop flat spots from damage or wear and the bearing will turn on the center rim roughly, or the sealed bearing will show lubricant leakage.

Replacement Part Needed:

- P/N 30951-01 Bearing, Ball, Radial, Sealed, 5 ID X 16 OD X 5 Thk

Replacement Procedures:



Figure 1 - Radial Bearing

1. Color change to Needle #1.
2. Turn the machine OFF.



Figure 2 - Radial Bearing Behind Needlecase

3. The radial bearing will then be accessible as shown in Figure 2 above. Remove the two thread tubes above the bearing.
4. Remove the screw with a .074" or 3mm Allen wrench and the split lock washer.
5. Install the replacement bearing and start the screw with a split lock washer loose.



Note: The radial bearing is a sealed bearing and does not require any additional lubrication.

6. Position the radial bearing so it depresses the stud on the back of the thread feeder arm for needle #1 about half way, then tighten the screw to torque specifications.
7. Check that the bearing depresses the stud on the rest of the needle positions.
8. Replace the thread tubes in position above the screw.

Thread Feeder Stepper Motor Assembly

The thread feeder stepper motor requires replacement when it fails. Failure of the thread feeder motor is usually obvious: overheated motor, electrical smell, or motor fails to feed thread or fails to function satisfactorily in both directions. There are other situations which will be determined through the troubleshooting processes that will require the stepper motor to be replaced.

 *This repair requires timing and other adjustments and can only be done by an authorized service technician.*

Replacement Parts Needed:

- P/N 30644 Motor, Stepper, Bi Polar, 1.8 Degree, 0.22 Nm
- Screw, Set, Flat Point, M4x6mm LG

Replacement Procedure:



Figure 1 - Thread Feeder Stepper Motor

1. Disconnect the harness from the stepper motor.
2. Use a marker and scribe a line onto the housing around the thread feeder PCB, then remove the PCB.
3. Remove the three screws, lock washers and flat washers mounting the stepper motor and remove the motor.
4. Loosen the set screw in the pulley collar and remove the feeder drive gear from the motor spindle.
5. Remove the set screw and replace it with a new one. Add red loctite (MS 222) to the set screw threads and install it into the feeder drive gear loose.
6. Install the feeder drive gear onto the stepper motor spindle so that the set screw is centered on the flat portion of the thread feeder gear.
7. Tighten the set screw in the feeder drive gear just until it starts to make contact with the flat section on the motor spindle.
8. Push the feeder drive gear towards the motor until it hits a hard stop and tighten the set screw to the torque specifications.
9. Install the motor onto the housing bracket, starting the screws loose, then tighten them to the torque specifications.
10. Reinstall the thread feed sensor PCB aligning it to the scribe marks and make sure that the optical sensor is centered to thread feed gear teeth (flag).

BERNINA

11. Connect the thread feeder harness to the motor.
12. Turn the machine on and launch BERNINA E16 OS.

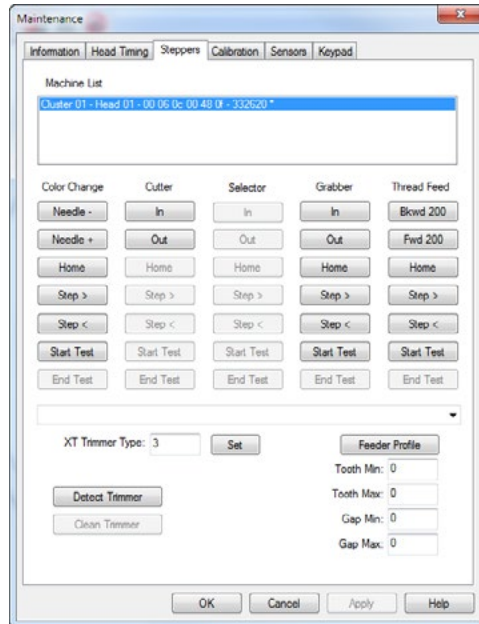

Figure 2 - Steppers Menu

13. Open the "Tools>Maintenance" menu from the BERNINA E16 OS main menu and select the "Steppers" tab.
14. Under the "Thread Feed" column, click on "Home". Check the alignment of the white thread feed gears by color changing and verify that there is no clicking sound during the movement.

BERNINA

Laser Pointer Assembly

WARNING!! This procedure is intended to be performed only by specially trained service technicians and personnel. Disassembly by untrained individuals will void any warranty protection and can result in personal injury or damage to the machine.

WARNING!!! DO NOT allow the laser beam to be aimed at yours or anyone else's eyes. The laser emits a very concentrated light beam that can cause permanent blindness. Use extreme care in handling the laser assembly to make sure it is not going to be inadvertently aimed at someone's eyes or face. DO NOT LOOK DIRECTLY AT THE LASER LENS WHILE IT IS ENERGIZED!



Replacement Parts Needed:

- 1 inch laser assembly

Replacing the laser assembly:

1. Color change to Needle 1 and then engage the E-stop button.

WARNING!! DO NOT proceed past this point until the e-stop button has been engaged. Failure to do so can cause personal injury or damage the machine.



Figure 1 Laser Assembly Installed

BERNINA



CAUTION!! Do not touch the metal laser housing to the casting. Do not ground the laser housing to other metal components. This will damage the laser.

2. Remove the upper right front cover and set the four M4x8mm flanged head socket screws and one M4x6mm button head cap screw aside for reuse.
3. Loosen the two M3x16mm socket head cap screws mounting the laser mounting block to the machine casting (do not remove them).
4. Pull the laser body carefully out of the white laser mounting block.
5. Check the focus of the laser light by aiming the light at a flat surface about 10 feet away and safely away from other people. The dot should be sharp and round, not blurry or oblong. If the laser light is out of adjustment, it must be adjusted by a specifically trained service technician. If the light is defective, replace it with a new one.
6. Insert the laser body into the white laser mounting block and center it inside the block.
7. Disengage the E-stop button on the keypad.
8. Place a round dot or piece of tape over the needle plate hole. Take the machine to needle depth and then back to head up (this is to make the focus point of the laser easier to see).



CAUTION!! Do not color change with the upper right front cover removed!

9. Adjust the position of the laser mounting block so that the laser beam is focused and centered on the needle plate hole. You can turn the laser on by pressing the laser key on the user interface.



Note: Ideally, if the laser beam is focused perfectly, the laser beam should be focused inside the circumference of the needle plate hole and not touch the sides of the needle plate hole. While this is the ideal standard for adjusting the laser beam, it is more important that the laser light is centered as perfectly as possible over the center diameter of the needle plate hole.

10. When the laser beam is centered as perfectly as possible on the needle plate hole, hold the mounting block securely in place and tighten the screws to the torque specifications.
11. Reinstall the upper right front cover.

LED Cluster PCB Replacement

The purpose of the LED cluster is to illuminate the fabric while the machine is sewing. None of the individual LEDs have any particular significance or indication as to the condition or position of the machine. Failure of either LED cluster or any of the individual LEDs on them will not affect the functionality of the remainder of the machine. There are two LED Cluster Assemblies installed on the bottom of the upper arm at the front of the machine, one on the left, the other on the right side.

If both LEDs are not illuminating when the machine is powered up, and no other obvious causes resulting in the LED clusters failure to illuminate can be found, extra troubleshooting and harness replacement might be required. This kind of repair has to be completed by an authorized service technician.

If the failure only involves a replacement of a LED Cluster Assembly, this repair can be completed by the machine operator.

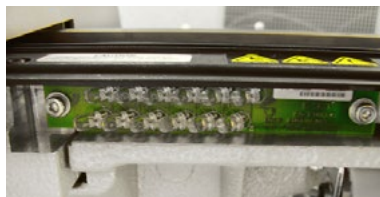

Figure 1 - LED Cluster Assembly

1. Each LED cluster is accessible from underneath the upper arm of the sewing head.



WARNING! The LEDs may be hot to the touch when illuminated. They must be turned off for a few minutes before handling or they can cause minor burns.

2. Turn off the machine and allow the LED's to cool for a few minutes.
3. Remove the two M4x6mm cap head socket screws and M4 flat washers and set them aside for reuse.
4. The LED cluster assembly should drop down when you remove the screws. If it does not, carefully remove it from it's position.
5. Disconnect the LED Cluster Assembly Harness from the LED Cluster Assembly and replace the cluster with a new one.
6. Connect the LED Cluster Assembly Harness to the LED Cluster Assembly.
7. Install the LED Cluster Assembly to the bottom of the upper arm with two M4x6mm cap head socket screws and M4 flat washers. Tighten the screws to the torque specifications.
8. Turn the machine on. The LEDs should all illuminate.

Presser Foot Assembly Replacement



This procedure should be done only by an authorized service technician.

Repair Parts Needed:

- Presser Foot Assembly Repair Kit

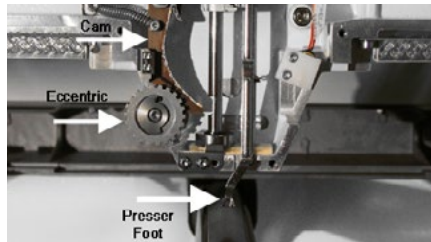

Figure 1 - Presser Foot Assembly Installed

1. When replacing the presser foot assembly, replace ALL of the parts that are in the presser foot assembly repair kit.
2. With the machine on, take the z-shaft to its HEAD UP position.
3. Turn the machine off.
4. Pull all of the thread out of the needles only and tie them all together in a knot at the bottom.
5. Remove the needle case access cover.
6. Remove the needlecase cover and let it hang on the bottom by the threads.
7. Loosen the top screws on both the left and right color change spindle mounting brackets.



Figure 2 Wire Installed Through Take Up Levers

8. Slide a stiff wire (e.g., a piece of hanger wire) through the take up levers as shown above to keep the take up levers together (to make it easier to reinstall the needlecase later).
9. Slide the needlecase carefully to the left and allow the first two needles to drop.
10. Remove the right upper arm front cover.
11. Loosen the top and bottom M4x4mm flat point set screws that hold the presser foot shaft in place.



CAUTION!! *Hold onto the spring as you remove the presser foot guide shaft. It might jump when the pressure on it is released.*

BERNINA

12. Remove the presser foot, bushing and spring by pulling them straight out of the upper arm casting.
13. Place the upper presser foot bearing in position on the presser foot for installation and hold it in place.
14. Place the presser foot assembly in place on the machine as shown in Figure 1 and start the guide shaft into the top bearing. Note the position of the upper portion of the presser foot with the reciprocator shaft.
15. Install a plain plastic bearing flange into the top of the spring.
16. Insert the spring and push the guide shaft through the spring into the lower presser foot bearing.
17. Turn the presser foot guide shaft until the flats at both ends face towards the front.
18. Pull the presser foot guide shaft down until it seats into the lower hole in the upper arm body.
19. Tighten the set screws on the top and bottom of the upper arm to the torque specifications. Make sure the top of the shaft is below the top face of the casting.
20. Lift the needle bars that have dropped down one at a time so that the needle studs align with the others and slide the needlecase over to the right. When all of the needles are up and aligned, center needlecase. Lift the presser foot to clear the right side of the grabber.
21. Adjust the needle case left or right as needed so that the end of the color change spindle is even with the outside edge of the right color change spindle mounting bracket.
22. Tighten the top screws on both the left and right color change spindle mounting brackets to torque specifications.
23. Install the needle case cover and access cover.
24. Pull the slack out of the threads and press them into the thread retaining spring located on the front of the needlecase cover, cutting the excess right at the spring.
25. Turn the machine on.
26. Go to bottom dead center in the Maintenance Menu in the BERNINA E16 OS software and verify left and right needle centering in the needle plate hole.



Note: The above procedure is based on the assumption that left to right needle centering was correct before the screws on the color change spindle mounting brackets were loosened.

27. You now need to verify the distance from the needle to the presser foot. The nominal distance from the centerline of the needle / needle bar to the lowest inner surface of the presser foot is 2.5mm.

BERNINA



One way to verify this distance is described below.

28. Replace any needle with a drill blank (or straight wire) with a diameter of 1.6mm (0.0625in) and a length of approximately 30mm (1 3/16").
29. By rotating the upper z-shaft, move the corresponding needle bar down until the presser foot reaches its lowest position.
30. The distance between the drill blank and the inner surface of the presser foot should be approximately between 1.5mm and 2mm. To check this distance, first place a 1.5mm (1/16") hex wrench between the drill blank and the presser foot.

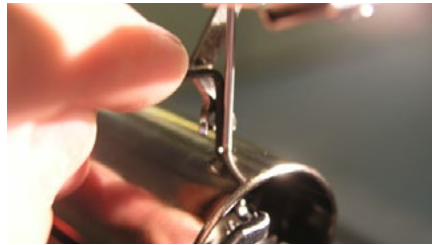

- If the hex wrench does not fit, the distance is too small (proceed to step 31).
 - If the hex wrench fits, you then need to verify that the distance is not too large. To do this, place a 2mm (5/64") wrench between the drill blank and the presser foot. If it fits snugly, the distance is correct. If it fits loosely, then this distance is too large (proceed to step 32).
31. If you determine that the distance needs to be adjusted, carefully bend the presser foot in the appropriate direction, then repeat step 30 to check the distance. Repeat this process until the distance is corrected.
 32. Verify that the presser foot is not interfering with the grabber trap (see image below).

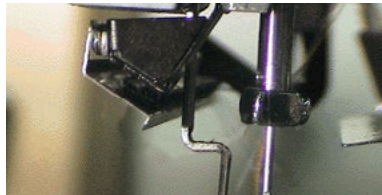

33. To adjust the presser foot height if needed, see the presser foot height adjustment section.

Reciprocator

i This repair requires timing and other adjustments and should be performed by an authorized service technician.

Replacement Parts Needed:

- Reciprocator Repair Kit

Replacement Procedure

1. Remove the needle case as described in the Needle Case Removal section.
2. Remove the left and right upper arm covers.
3. Locate the reciprocator assembly as shown below.

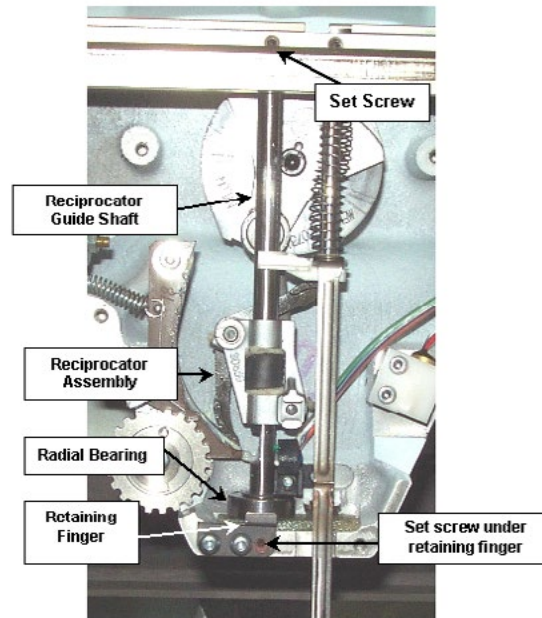

Figure 1 - Reciprocator Assembly Installed

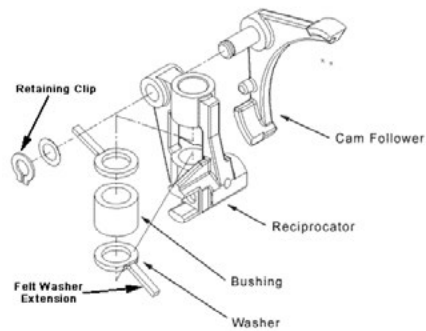

Figure 2 - Reciprocator Assembly

BERNINA

4. Remove the two screws that hold the retaining finger in place.
5. Loosen the set screws at the top and bottom of the head that secure the reciprocator guide shaft.
6. Remove the reciprocator guide shaft by sliding it up and through the hole at the top of the upper arm casting.
7. Remove the reciprocator assembly from the connecting rod by pulling it straight out of the upper arm casting.



Note: When any component in the reciprocator assembly requires replacement, it is strongly recommended to replace the entire reciprocator assembly.

8. Install the reciprocator guide shaft as follows:
 - a. Attach the connecting rod to the reciprocator.
 - b. Insert the guide shaft down through the hole at the top of the upper arm casting and through the presser foot guide.
 - c. Insert the guide shaft through the reciprocator assembly.
 - d. Insert the guide shaft down through the ball bearing, the bushing below the ball bearing, and the bottom felt.
9. Turn the reciprocator guide shaft until the flat position at the top of the shaft faces towards the front of the upper arm casting.
10. Pull the reciprocator guide shaft down until it is positioned below the upper surface at the top of the upper arm casting by 0.5 to 1.0mm.
11. Position the z-shaft at top dead center, (to allow the felt to capture the oil in the next step) by turning the machine on without the software open. The machine will automatically go to top dead center (assuming that the z-shaft drive is properly timed). If the software is open, close it before performing this step.
12. Add approximately 25 drops of machine oil into the oiling hole located just above the reciprocator assembly while the reciprocator is in the upper position.
13. Tighten the set screws on the top and bottom of the head to secure the reciprocator guide shaft and assembly.
14. Install the left and right upper arm covers.
15. Reinstall the needlecase.

Take-Up Lever Cam Replacement

The take-up lever cam may wear out over time and need replacement. Replace the cam following these procedures.

 *This repair requires timing and other adjustments and should be done by an authorized service technician.*

Replacement Part Needed:

- Take-Up Lever Cam

Replacement Procedure

1. Remove the needlecase.
2. Remove both the left and right front arm covers.



Figure 1 - Take-Up Lever Connecting Arm

3. Remove the screw connecting the connecting rod assembly to the take-up lever cam and disconnect the connecting rod from the take-up lever cam. Use a screwdriver that fits the slot correctly as the screw threads have red loctite (MS 222) applied and may be difficult to break loose.



CAUTION!! *DO NOT DISASSEMBLE THE Z-SHAFT ITSELF OR ATTEMPT TO REMOVE IT! If you remove the retaining rings at either end of the z-shaft, the machine will have to be sent in to the factory for repair. The illustrations below are shown on a z-shaft that is removed from the machine for clarity purposes only.*



Figure 2 - Remove Center Screw

4. Remove the center screw connecting the z-shaft end plate to the upper z-shaft.
5. Remove the take-up lever cam (with the z-shaft end plate attached) from the upper z-shaft.

BERNINA



Figure 3 - Screws On Back of Take-Up Lever Cam

6. Remove the screws mounting the z-shaft end plate to the take-up lever cam.



Figure 4 - Remove Hex Nut

7. Remove the M4 hex nut from the take-up lever cam and put it in the replacement cam.
8. Apply red loctite (MS 222) to the M4 screws and attach the z-shaft end plate to the take-up lever cam. Make sure the M4 hex nut does not fall out of the recessed hexagonal hole in the take up lever cam. Tighten the M4 screws to 10.5 in-lbs[1.2 Nm] of torque.



Figure 5 - Endplate w/Spring Pin Pressed in EndPlate- back view

9. Push the spring pin into the z-shaft end plate from the front until it is flush to the back of the end plate (see figure 5).

i *Important: When inserting the spring pin, make sure the spring pin teeth are facing down.*



Figure 6 - Alignment Groove in Z-Shaft

10. Align the spring pin in the z shaft end plate with the groove of the upper z-shaft and press onto the end of the shaft.
11. Push the spring pin back into the end plate if it slips out while pressing it onto the z-shaft.
12. Apply red loctite (MS 222) to the M5 screw and install it to the end of the upper z-shaft and tighten it to 66.5 in-lbs[7.5 Nm] of torque.

BERNINA

13. Apply red loctite (MS 222) to the upper connecting rod bolt and assemble the connecting rod assembly to the take-up lever cam. Tighten the bolt to 35 in-lbs[4 Nm] of torque. (Figure 1)
14. Install the left and right front arm covers.
15. Install the needlecase.

Z-Drive Repair and Adjustment

The Z-Shaft assembly should never be disassembled by other than factory authorized personnel. There are no user or field technician serviceable parts on the z-shaft assembly. Service all z-drive components only by using the procedures contained in these instructions.



CAUTION!! Do not disassemble any parts physically connected to the z-shaft itself, except as provided in the following instructions. Installation and assembly of the z-shaft assembly requires special training and tools and should never be attempted outside of the factory.

All of the procedures below can be accomplished only by authorized field service technicians. Do not attempt to perform any of the procedures below unless you have received specific training that allows you to do so. Click on the link to get to the procedure.

- Take-Up Lever Cam Replacement
- Z-Motor Assembly Replacement

The following procedures may be performed by the machine operator.

- Z-Drive Belt Replacement and Tensioning
- Z-Idler Pulley Replacement
- Z-Home Optical Sensor PCB Replacement

Z-Drive Belt Replacement and Tensioning

The z-drive belt should be replaced when it shows signs of dry rot (cracking), the sides of the belt gain a glossy look, or the belt breaks. Care needs to be taken to make sure that the z-drive belt is properly tensioned to specified ranges.

Replacement Part Needed:

- Belt, Timing, Closed, HTD 5M X 9 X 710 Lg

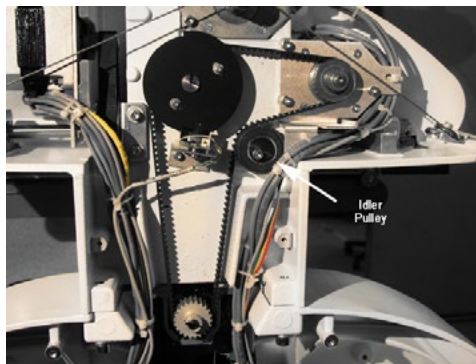

Figure 1 - Z-Motor Drive Belt

Replacement Procedure

1. Remove the left and right upper arm covers.
2. Remove the upper arm back cover.
3. Remove the lower arm rear cover.

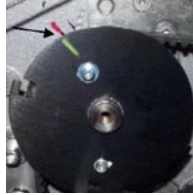

Figure 2 - Z-Home Flag With Index Mark

4. Using a permanent marker, mark a common index mark on both the z-home flag and the upper arm body as shown in Figure 2 above.



Figure 3 - Lower Z-Shaft Drive Pulley

5. Place an index mark on the lower z-shaft drive pulley and the lower arm body as shown in Figure 3 above.
6. With the machine turned off, slowly loosen the idler pulley screw and rotate the idler pulley counter clockwise to remove the tension on the belt and then remove the belt.
7. Place the new belt on the upper and lower shaft pulleys, keeping both pulleys aligned to their respective index marks as shown in Figures 2 and 3 above.
8. Place the belt on the z-motor drive pulley.



CAUTION!! *The head must be timed at this point. Check head timing using the procedures prescribed in "Head-Up Position Adjustment".*

9. Position the belt over the idler pulley (Figure 1) and slowly rotate the idler pulley clockwise until the belt is tensioned and then tighten the screw on the idler pulley to the torque specifications. Check and make sure the head is timed using the procedures prescribed in Head-Up Position Alignment.



CAUTION!! *Improper tensioning of belts can cause internal damage to the machine. Tension belts carefully and accurately.*

10. Check and adjust the tension of the z-belt as prescribed in "Z-Drive Belt Tensioning".
11. If you do not have any more repairs to do to the machine, replace the machine covers in the reverse order they were removed.

Z-Home Sensor PCB Replacement



This repair requires timing and other adjustments and should be performed by an authorized service technician.

Repair Parts Required:

- Z-Home Sensor PCB Assembly (includes the bracket)



WARNING!! *Do not take the covers off the machine without either turning the machine off or engaging the emergency button. The motors might move when the sensor is removed or the harnesses are disconnected.*

1. Either turn the machine off or engage the emergency stop button by pressing it in.
2. Remove the left and right arm covers and set the hardware aside for reuse.
3. Remove the upper arm back cover and set the hardware aside for reuse.
4. Disconnect the z-home harness lead from the PCB connector socket.
5. Remove the two M4x10mm cap head socket screws, M4 split lock washers, and M4 flat washers that mount the bracket to the upper arm and remove the Z-home sensor PCB assembly from the machine.
6. Install the replacement Z-Home Sensor PCB Assembly using the hardware you removed from the old assembly using the Z Home Sensor Fixture (PN: 32980) to correctly realign the assembly. See Figure 1.



Figure 1 - Z-Home Sensor Fixture

7. Align the mounting bracket of the replacement PCB using the Z Home Sensor Fixture (PN: 32980). Make sure the fixture contacts the outside face of the opto sensor on the PCB. Position the bracket until the fixture contacts the outside diameter of the Z Home Flag. See Figure 2.

BERNINA

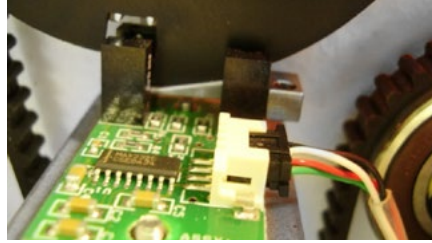

Figure 2 - Z-Home PCB Mounting Bracket

i **NOTE:** Make sure that the flag is centered front to rear between the sensors on the optical PCB. Adjust PCB if required.

8. Tighten the screws to the torque specifications and remove the fixture.
9. Connect the z-home harness lead into the PCB connector socket.
10. Use a small plastic cable tie and tie the connector snug by attaching the cable tie around the PCB such that the cable tie holds the connector in place. Failure to do this might result in the connectors coming loose which can create difficulties in troubleshooting. See Figure 3.



Figure 2 - Cable Tie Around PCB

11. Reinstall the upper arm back cover and tighten the screws to the torque specifications.
12. Reinstall the left and right arm covers and tighten the screws to the torque specifications (use minimum torque required for clamping plastic materials).

Z-Belt Idler Assembly Replacement

The z-belt idler assembly has internal bearings that may get damaged by a machine fault or an operator error such as over tensioning the z-drive belt.

Replacement Part Needed:

- Z-Belt Idler Assembly



Figure 1 - Z-Belt Idler Pulley

1. Remove either the left or the right arm covers and the back screw on the other one. (It does not matter which one.)
2. Remove the upper arm back cover.

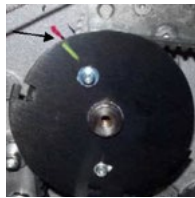

Figure 2 - Index Mark on Z-Index Flag



Figure 2 - Lower Z-Shaft Pulley

3. To preserve synchronization of the upper and lower z-shafts, make index marks on the z-index flag and the bottom pulley as shown in Figures 2 and 3 above.
4. Slowly loosen the screw mounting the z-belt idler pulley to release the tension on the belt, then remove the idler pulley.
5. Mount the replacement idler pulley with the same screw from the old one, leaving the screw loose.
6. Tension the z-drive belt and tighten the idler pulley using the procedures specified for installing the z-drive belt, keeping the index marks (Figures 2 and 3) lined up.
7. Install the covers in the reverse order you removed them with.
8. Power the machine up and perform a function test for about 5 minutes to make sure the z-axis movements are satisfactory.

Z-Motor Assembly

The Z-motor assembly should also be replaced when the resistance between each of the phases is inconsistent or substantially different than $1.04 \pm 10\% \Omega$ for the short z-motor and $0.57 \pm 10\% \Omega$ for the long z-motor. In addition, the resistance between each of the phase wires should be relatively consistent with the other wires.

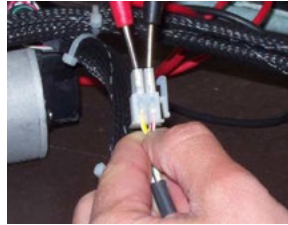

Figure 1 - Measuring Resistance Between Motor Phase Wires

Resistance of the z-motor phase wires can be measured at the connector with an Ohmmeter as shown in Figure 1 above. Disregard the green (ground) wire and measure the resistance between each combination of the other 3 wires.

Measuring resistance however, is not the only factor to be used in determining whether to replace a motor or not. Examples of other issues that should be considered is how freely and smoothly the spindle on the motor turns. These factors are covered in the troubleshooting section of this manual.

Replacement Parts Needed:

- Z-Axis Brushless Servo Motor
- 6-11 inch Cable Ties (to re-tie the harnesses after installing the new motor) (available in the electrical section at most hardware stores)

1. Turn the machine OFF.
2. Remove the left arm cover and the screw from the back of the right one.
3. Remove the upper arm back cover.



CAUTION!! Use extreme care not to drop metallic objects, tools, or other conductive material on the Main PCB when you have the base cover removed. If you drop such objects on the Main PCB, it can severely damaged the electronics which will be very expensive to repair.

4. Remove the base cover.
5. Remove the lower arm rear cover.



Figure 2 - Z-Motor PCB Connections

BERNINA

6. Disconnect both the z-motor harness and motor and hall sensor leads (marked "CONTROL PCB Z MOTOR" and "CONTROL PCB Z HALL/ENC") from the main PCB at connector locations "Z Motor" and "Z Hall Enc".
7. Use a small pair of wire cutters and cut off the cable ties that tie the z-harness to the user interface harness.
8. Pull the z-harness all the way through the cable through-hole to the back of the machine and let the harness hang off the back of the machine.



Figure 3 - Z-Belt Idler Pulley

9. Slowly loosen the z-belt idler pulley to remove the tension from the z-drive belt.
10. Cut all of the cable ties that tie the x- and z-harness leads together.

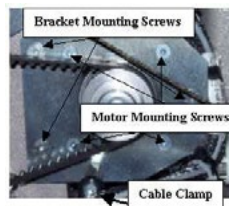



Figure 4 - Z-Motor Mounting Screws

11. Remove the cable clamp located at the bottom of the z-motor mounting bracket.
12. Remove the bracket mounting screws as shown in Figure 4 above.
13. Pull the x-cable out of the way and remove the z-motor from the machine.
14. Remove the z-motor timing pulley from the z-motor.
15. Remove the z-motor mounting bracket from the z-motor, install it on the replacement motor, and tighten the screws to the torque specifications.

 **CAUTION!!** Do not drop the z-motor timing pulley or allow the star washers that are pressed inside the bore to come loose. If the star washers fall out or come loose, the timing pulley must be replaced. If you install a timing pulley with the star washers loose or missing, damage to the machine will likely result.

16. Install the z-motor timing pulley onto the z-motor shaft and tighten the screw to 8 in-lbs[0.9 Nm]. This must be done with a reliable torque wrench.
17. Mount the motor assembly to the upper arm as shown in Figure 4 above and tighten the screws to The torque specifications.

BERNINA

18. Use a cable tie and tie the z-motor harness to the adjacent harness leads at the z-motor mount standoff (x-harness leads and the Control Board LED lead).
19. Attach the cable clamp to the z-motor lead (marked "CONTROL PCB Z MOTOR") and attach the cable clamp at the bottom of the z-motor mounting bracket as shown in Figure 4. Tighten the screw to The torque specifications.
20. Use a cable tie and tie the z-motor harness leads and the adjacent leads together right before the clamp.
21. Tie the z-motor harness to the adjacent harnesses at about every 3 inches and route the z-motor harness leads down the back of the machine to the cable access hole. Connect the motor harness and hall/encoder leads to the main PCB.
22. Tension the z-drive belt as specified in Z-Belt Replacement and Tensioning.
23. Unless you have additional work to do on the inside of the machine, install the covers back onto the machine in the reverse order you removed them.

Clearing Thread from Thread Feeder Roller

When the thread or material feed settings are too loose, birdnesting often results when thread is pulled into the thread feeder and wraps around the thread feeder roller. This is easily cleaned out by following the below procedures.

When the thread or material feed settings are too loose, birdnesting often results when thread is sucked into the thread feeder and wraps around the thread feeder roller. This is easily cleaned out by following the below procedures.

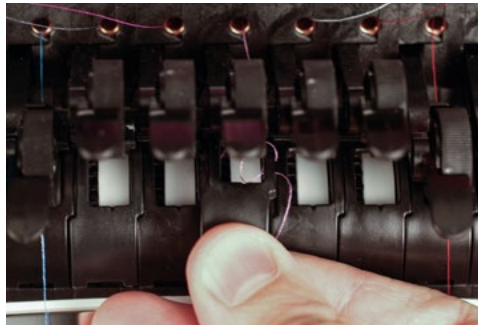

Figure 1 - Removing Thread Feeder Front Cover

1. First lift the lever of the thread feeder where the thread has wrapped around the roller and the two adjacent thread feeders and remove all three thread feeder front covers.

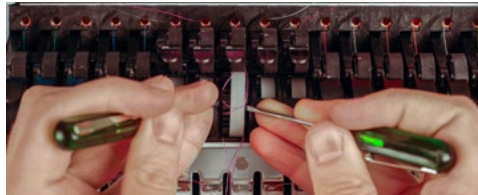

Figure 2 - Prying Thread Feeder Roller Loose

2. Using two thin bladed flat screw drivers or the tool provided in the ops kit, carefully remove the roller from the assembly as shown in Figure 2 above until you can pull it out easily with your finger.

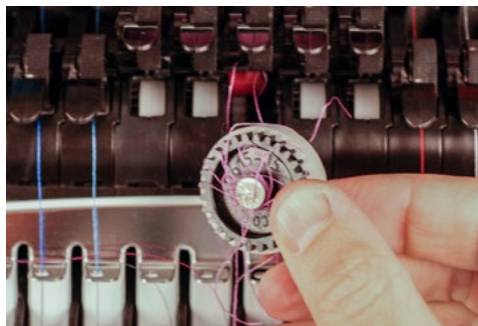

Figure 3 - Pulling Thread Feeder Roller Out

3. Once the roller is pried out enough to grab onto it with your fingers, pull it the rest of the way out and remove the thread wrapped around it.

BERNINA

4. Remove any birdnesting or loose thread from the inside of the thread feeder assembly. Also check and remove any thread feeder wrapped around the thread feeder gear next to the stepper motor behind the needlecase.
5. Inspect the thread feeder roller rubber pad for damage, especially a groove cut into the pad where the thread runs, or any nicks or other damage (caused by pulling thread through without lifting up the red thread feeder arms). If any damage is found, replace the roller with a new one. Align the roller in place, and push it all the way in until it snaps into place.
6. Insert the covers in place by moving the thread out of the way and inserting the top end of the cover into the slot at the top of the thread feeder assembly and then pushing it into the assembly until it snaps back into place. Make sure the thread is centered (critical) over the thread feeder front cover.
7. Rethread the machine if necessary and then make sure the thread is centered in the grooves on the thread feeder front cover and push the thread feeder arm back down.
8. In the BERNINA E16 OS, open up the “Tools>Settings” menu, and then click on the “Thread Feed” tab. Check the settings for the thread and material feed and make sure they are correct. You will probably need to adjust them. Refer to the Operator’s Manual section on the “Thread Feed Tab” for information on using this menu.
9. Run a test sew on any design to observe the performance of the thread feeder assembly and make additional adjustments or repairs as needed.

Color Change Spindle Mounting Bracket Replacement

Parts needed for repair:

- left color change spindle mounting bracket (only if damaged)
- right color change spindle mounting bracket (only if damaged)

The color change spindle mounting brackets require replacement only when the screw holes are stripped out beyond repair or the bracket is cracked or otherwise damaged. This will usually occur only when the needle case has to be disassembled.

1. Remove the needlecase access cover.
2. Remove the two button head screws holding the needlecase cover onto the needlecase.
3. Remove the needlecase cover.



Figure 1- Left Color Change Spindle Mounting Bracket

4. Left Color Change Spindle Mounting Bracket Replacement: (only if damaged)
 - a. Color change to Needle 1.
 - b. Engage the emergency stop by pressing it in.
 - c. Carefully bend the ends of the cotter pin together and release the spring from the bracket. Do not let the spring snap back on its own.
 - d. Loosen and remove the cap head screw on the top of the bracket and set it aside for reuse.
 - e. Remove the two cap head screws and split lock washers on the side of the bracket and set the hardware aside for reuse.
 - f. Remove the mounting bracket and throw it away.
 - g. Install the new bracket on the color change linear actuator spindle.
 - h. Insert the cotter pin into the hole in the bracket from the right side and bend the cotter pin apart so the ends bend flat against the left side of the bracket.
 - i. Apply red Loctite (MS 222) to two M4x16mm cap head screws and start them with two M4 split lock washers into the left side of the bracket and attached the bracket to the needle case. Leave the screws installed loose.
 - j. Release the emergency stop button.
 - k. Color change to needle 16 and then tighten the screws to the torque specifications once both screws are started.

BERNINA

- I. Color change to Needle 8 and then apply red Loctite (MS 222) to the M4x8mm cap head screw and install the screw into the top of the bracket, tightening it to the torque specifications.

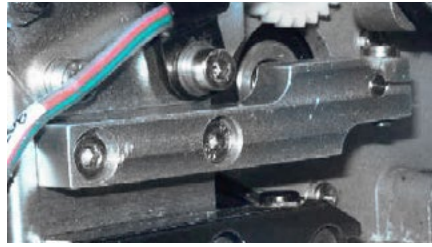

Figure 2 - Right Color Change Spindle Mounting Bracket

5. Right Color Change Spindle Mounting Bracket Replacement (only if damaged):
 - a. Color change to needle 16 to expose the top screw.
 - b. Loosen and remove the M4x8mm cap head socket screw from the top of the bracket and set it aside for reuse.
 - c. Remove the two M4x6mm cap head socket screws from the side of the bracket and set them aside for reuse.
 - d. Remove the damaged bracket and throw it away.
 - e. Install replacement bracket in place on the color change linear actuator spindle.
 - f. Apply red loctite (MS222) to the two M4x6mm cap head socket screws on the side of the bracket and install the bracket to the needlecase. Leave the screws loose for now.
 - g. Release the emergency stop button if it is engaged.
 - h. Color change to needle 1 and then tighten the screws to the torque specifications.
 - i. Color change to needle 16, then apply red loctite (MS222) to the M4x8mm cap head screw and install the screw into the top of the bracket, tightening it to the torque specifications.
6. If you have no further work on the needlecase assembly, reinstall the needlecase cover and the access cover.

Grabber Blade Replacement

The grabber blade will need to be replaced if it is damaged due to a machine or operator error. It should be replaced anytime the blade is nicked, bent or damaged in any manner. Damage to the grabber blade usually occurs because the path of the grabber blade is obstructed, the grabber assembly is not properly adjusted, or the screws are loosened or not properly torqued.

Parts Needed for Repair:

- Grabber Blade
- Four (4) M3x6mm flat head slotted screws

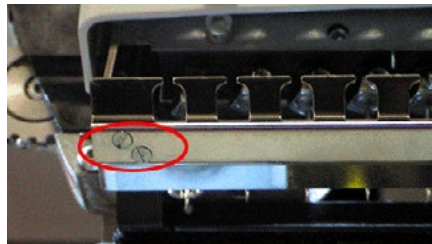

Figure 1 - Grabber Blade (bottom view)

1. Remove the four M3x6mm flat head screws on the bottom of the grabber blade and throw them away. It is recommended that you do not reuse the screws.
2. Apply red loctite (MS222) on the screw threads and install the replacement grabber blade in position, starting all four screws loose. Tighten them to the torque specifications when all of the screws are started.
3. Loosen the four M3x6mm button head screws on the back of the lower trap assembly.
4. With the machine tuned off, move the grabber blade by hand between the upper and lower trap assemblies and check the horizontal and vertical alignment.

i **NOTE:** Rotate the grabber home flag on the back of the needlecase if the grabber blade cannot be moved by hand.

5. If the grabber blade is aligned between the two trap assemblies, then proceed to step 7. Otherwise adjust the grabber blade to the upper trap assembly using the following procedures.
 - a. Move the grabber blade back out from the upper and lower trap assembly.

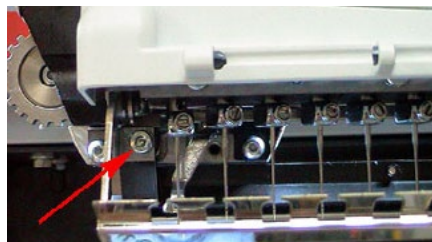

Figure 2 - Upper Trap Assembly Front Screw

BERNINA

- b. Loosen the front M4x6mm cap head socket screw mounting the upper trap assembly to the needlecase.



Figure 3 - Upper Trap Assembly Hex Nut

- c. Loosen the two M4 hex nuts located at the bottom of the right side of the needlecase.
 - d. Move the grabber blade back in between the upper and lower trap assemblies.
 - e. Tighten the front screw mounting the upper trap arm to the front of the needlecase to the torque specifications.
 - f. Tighten the two M4 hex nuts on the bottom right side of the needlecase to the torque specifications. Make sure the grabber blade is engaged evenly from needle 1 to needle 16 before tightening down the nut.
 - g. Tighten the four M3x6mm button head screws that mount the lower trap assembly to the upper trap assembly to the torque specifications.
 - h. Move the grabber blade back out of the needle case to it's full extended position.
 - i. Move the grabber blade in and out of the upper and lower trap assembly several times. It should just brush against the grabber trap velcro on the upper trap and be parallel all the way across.
 - j. Visually check the position of the grabber blade at the fully extended position. A vertical line extending down from the inside edge of the grabber blade should be $9.9\text{mm} \pm 0.3\text{mm}$ from a vertical line extending down the front of the nearest needle bar. If this adjustment is not correct, contact technical support for instructions.
6. Turn on the machine.

BERNINA

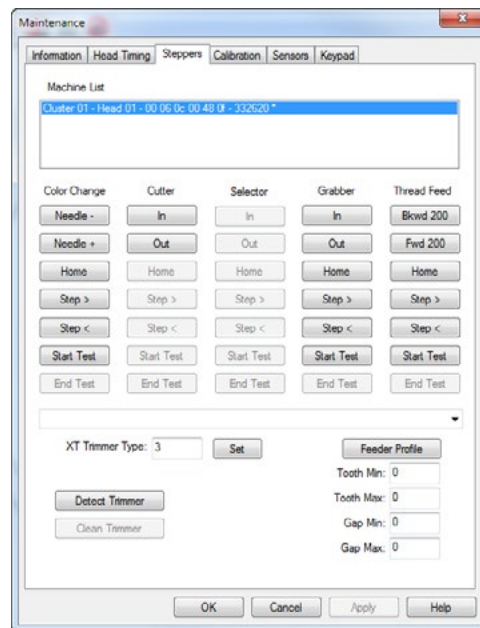



Figure 4 - "Steppers" Submenu

7. Open the "Tools>Maintenance" menu in the BERNINA E16 OS software and click on the "Steppers" menu tab. Under the "Grabber" column, click on the "Step>" button and manually run the grabber through it's cycle. Observe any rubbing of the grabber blade and look for other parts that might be out of adjustment and hitting the grabber blade. Contact Technical Support if other adjustments are required beyond the instructions provided for in this Manual.
8. If there is no obstruction or interference noticed when stepping the grabber through it's normal cycle, press "Start Test" to test the grabber (located under the "Grabber" column) and let the grabber test run for a few minutes. If the grabber fails to function correctly during the test, make adjustments as necessary. To end the grabber test, click on "End Test" under the Grabber column.
9. Run the "Trim Test" sew design "AMTRIM01A.exp" on the machine and watch for long tails and pullouts. If you have long tails and pullouts on the test design, you need to tighten up the adjustment slightly. Turn the machine off and repeat all the steps from Step 4 forward and tighten the adjustment of the grabber blade against the upper trap velcro.

Needle Case Removal

 This repair requires timing and other adjustments and should be done by an authorized service technician.

 **CAUTION!!** DO NOT disassemble the needle case any further than what is provided in this manual. If you do so, the alignment of the needle case will be severely compromised and extremely difficult to reset without the proper fixtures used at the factory.

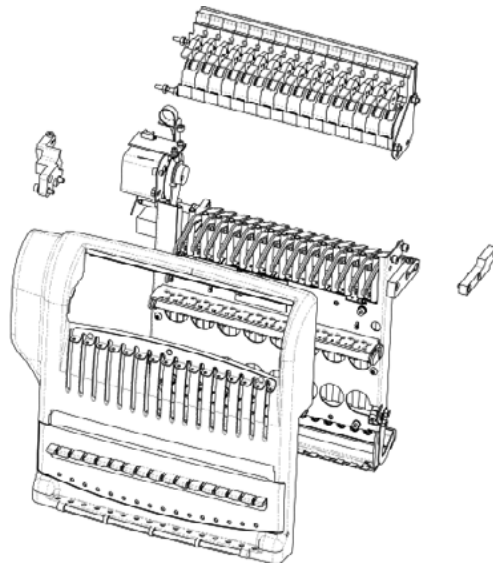



Figure 1 - Needlecase Assembly

1. Turn ON the machine and open the BERNINA E16 OS. Click on "Tools>Maintenance" menu and then "Head Timing" tab. Click on the "Head Up" button to bring the head to the HEAD UP position. If the machine is jammed or will not go to the head up position, contact Technical Support for instructions.
2. Color change to either Needle 5 or 6.
3. Engage the emergency stop by pressing in.

 **WARNING!** Do not proceed without engaging the emergency stop button or by turning the machine off. The machine may begin operating if you do not do so. This can result in severe damage to the machine and/or personal injury. You do not need to disconnect the power input cord from the machine.

4. Take the small access cover off the needle case assembly.

BERNINA



Figure 2 - Needlecase Access Cover Removed

5. Remove the 2 button head screws at the left and right of the access opening, holding the needle case cover, and remove the needle case cover (see Figure 2).
6. Loosen the top screw to the left color change spindle mounting bracket as shown in Figure 3.



Figure 3 - Loosen Top Screw

7. Remove the nut from the right color change spindle mounting bracket as shown in Figure 4.

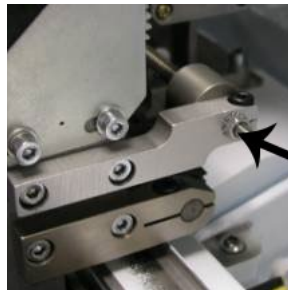

Figure 4 - Remove Nut

8. Loosen the top screw and remove the two side screws from the right color change spindle mounting bracket. Remove the right color change spindle mounting bracket.
9. Remove all of the thread tubes from the back of the thread feeder.



Figure 5 - Remove Thread Tubes

10. Disconnect the harnesses from the two PCB's and the stepper motor.
11. Slide the needle case to the left while lifting the presser foot to clear the grabber bracket.
12. The needle case will now be free to remove from the head.
13. Handle the needle case carefully so you do not damage any components.

Needlecase Installation

i This repair requires timing and other adjustments and should be done by an authorized service technician.

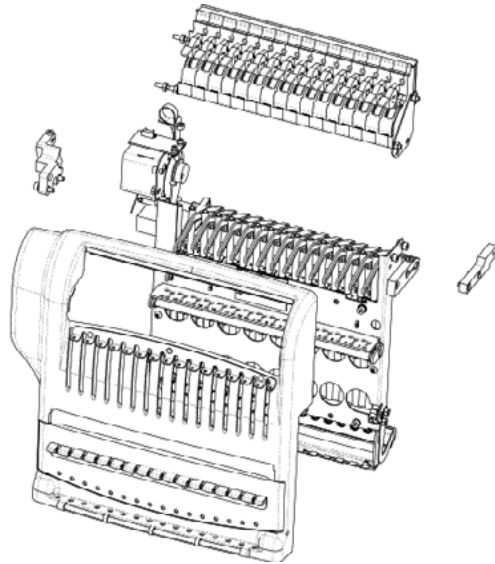

Figure 1 - Needlecase Assembly

1. Verify that the machine is turned OFF.

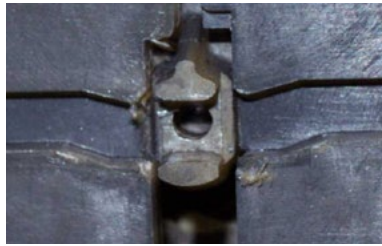

Figure 2 - Reciprocator at "Head Up" Position

2. Reach into the access opening on the bottom side of the sewing head and manually turn the z-shaft until the needle bar drive slot of the reciprocator is aligned to the drive grooves on the left and right upper arm covers as shown in Figure 2 above.
3. Handle the needlecase carefully so you do not damage any components.
4. Slide the needle case to the right while lifting the presser foot to clear the grabber bracket.
5. Connect the harnesses to the two PCB's and the stepper motor (Figure 1).
6. Install the 2 screws holding the needle case cover and tighten the screws to the torque specifications.
7. Install the right CC spindle mounting bracket, starting the two side screws loose and then tightening them to snug. Tighten the top screw to the torque specifications.
8. Tighten the top screw on the left CC spindle mounting bracket clamp.

BERNINA

9. Reconnect the thread tubes to the back of the thread feeder assembly in the correct numerical order from right to left (as you face the front of the needlecase).
10. Reinstall the needlecase cover.
11. Replace the needlecase access cover to the needle case assembly.

 *IMPORTANT! Verify needle depth and hook timing anytime you reinstall the needle case!*

12. Complete any remaining work you have left on the machine, then turn the machine back on. To do so, disengage the emergency stop (if it is engaged) by twisting in the direction of the arrows until the red button pops out and turn the main power switch ON.
13. Verify needle depth and hook timing.

Grabber Stepper Motor Replacement

The grabber stepper motor requires replacement when the grabber assembly fails to function and power supply failure to the motor has been eliminated as a cause. Before replacing the motor, conduct trouble shooting procedures to evaluate the failure between the main PCB, grabber harness and the motor.

Replacement Parts Needed:

- Bi-Polar Stepper Motor Subassembly
- One (1) M4x0.7x6mm Flt Pt Socket Set Screw

Replacement Procedure

1. Remove the needlecase access cover.
2. Remove the needlecase cover.

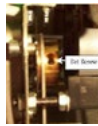

Figure 1 - Grabber Eccentric

3. Rotate the grabber eccentric with your fingers and remove the set screw in the grabber drive eccentric.



Figure 2 - Grabber Stepper Motor Mounting Screws

4. Remove the three M4x6mm cap head socket screws and M4 split lock washers that mount the grabber mounting plate to the needlecase frame.
5. Remove the four M3x4mm cap head socket screws mounting the motor to the grabber mounting bracket and set them aside for reuse.
6. Mount the grabber mounting bracket to the replacement motor.
7. Apply red loctite (MS222) to the four M3x4mm cap head socket screws. Start the screws loose and then tighten them to the torque specifications.
8. Align the motor shaft to the grabber drive eccentric and ensure the spindle enters the bore of the eccentric and does not push against the side of the eccentric.
9. Start three M4x6mm cap head socket screws into the motor bracket mounting it to the needle case frame, then tighten the screws to the torque specifications.
10. Apply red loctite (MS 222) to a new M4x0.7x6mm set screw and install it into the grabber drive eccentric and tighten it to the torque specifications.
11. If you do not have any further work on the needlecase assembly, reinstall the needlecase cover and access cover.

Take Up Lever Replacement

Take up levers require replacement whenever they are damaged in anyway. No fixtures are required to perform this procedure, but it must be completed by following these instructions explicitly.

Replacement Parts Needed:

- One (1) take up lever assembly (for each take up lever requiring replacement)

Replacement Procedure

1. Remove the needlecase access cover.
2. Remove the needlecase cover.
3. On the left end of the take up lever axis (take up lever shaft), use a black marker and mark on the axis where the inside edge of the left take up lever mounting block clamps onto the axis.
4. Turn the main power switch ON.
5. Color change to Needle 5.
6. Shut the machine OFF.
7. Remove the two screws mounting the right color change shaft mounting block and loosen the screw clamping the color change shaft. Remove the mounting block.



Figure 1 - Right Take Up Lever Bar Mounting Block

8. Loosen the top screw in the right take up lever mounting block.



Figure 2 - Right Take Up Lever Bar Mounting Block

9. Loosen the two top screws holding the take up lever bar in the left take up lever mounting block.

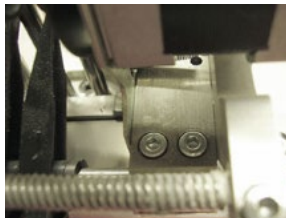

Figure 3 - Screws on Take Up Lever bar

BERNINA

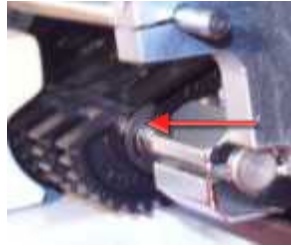

Figure 4 - Retaining Clip

10. Remove the retaining ring from the groove on the left side of the left take up lever axis. Set it aside for reuse.
11. Tap on the right side of the take up lever axis until the spacer on the right side can be removed and set it aside for reuse.
12. While holding the take up lever axis up slightly, slide each take up lever off towards the right side of the machine and remove them one at a time until you get to the first take up lever that needs to be replaced (closest to right side).
13. Install a new take up lever assembly in place so that the back groove (larger than the valleys) sits on the guide on the take up lever guide.
14. Tap the take up lever bar through each consecutive take up lever, replacing the remaining defective ones using the procedure in step 9.
15. Before you tap the bar through the end of the last take up lever, install the spacer into place and tap the take up lever through the spacer.
16. Install the retaining ring in the groove on the left end of the take up lever axis.
17. Tap the take up lever axis into the bore on the right take up lever bar mounting block so that the space between the last take up lever body and the right block is $.020" \pm .003"$ (with all of the take up lever bodies pushed against the retaining ring).
18. Tighten the top screws in both take up lever bar mounting blocks to The torque specifications.
19. Remount the right color change mounting bracket, leaving the screws loose.
20. Tighten the top screw in the right color change mounting bracket to The torque specifications.
21. Turn the machine ON. The machine will move each component to "home".
22. Color change to Needle 1.
23. Tighten the right color change mounting bracket screws to The torque specifications.
24. If you do not have further work in the needlecase assembly, install the needlecase cover and access cover.

Thread Feeder (replacement and adjustment)

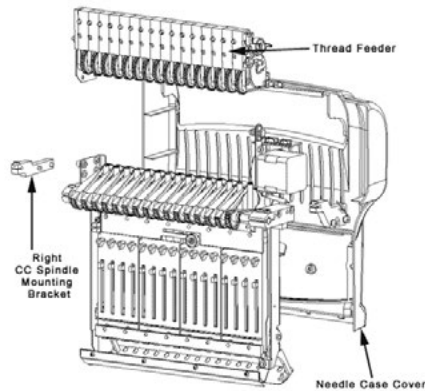

Figure 1 - Needle Case Assembly

Replacement Parts Needed: (for part numbers and description, click on the links)

- Thread Feeder Assembly, 16 Needle (comes with hardware installed)

Replacement Procedure

1. Turn the machine off.
2. Remove the needle case access cover.
3. Remove the needle case cover.



Figure 2 - Thread Tubes Connected to Thread Feeder Assembly

4. Remove the thread tubes from the back of the thread feeder.

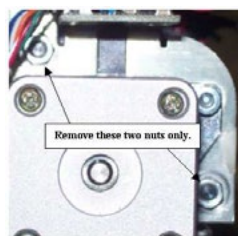

Figure 3 - Thread Feeder Assembly, Left Bracket

BERNINA

- Loosen the two nuts on the left side at the end of the long bolts as shown in Figure 3 above.

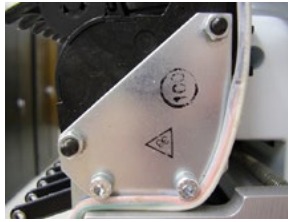

Figure 4 - Thread Feeder Assembly, Right Thread

- Remove the two socket head screws on the right side as shown in Figure 4 above.
- Remove the assembly with the 16 thread feeders to the right side as one unit. Do not disassemble the assembly any further.

i *IMPORTANT! Do not disassemble the 16 needle thread feeder assembly. Disassembly and reassembly of this component requires specific skills and alignments that are best done at the factory.*

- Turn the machine on and Color change to needle number 1.
- Slide the replacement thread feeder assembly onto the needle case.
- Replace and tighten the two bolts on the right side as shown in Figure 4 above. Tighten the bolts only enough to secure the bracket to the needle case.
- Install the nuts on the left bracket and tighten them just enough to hold the left bracket in place.
- Adjust the thread feeder assembly so that the thread feeder gear meshes with the gear on the Color Change, Take-Up Feeder Housing Assembly. See Figure 5. The maximum gap between the gears should be no more than .032" [0.81mm]. Gage Pin (PN: 32996) should not go between the two gears. See Figure 6.

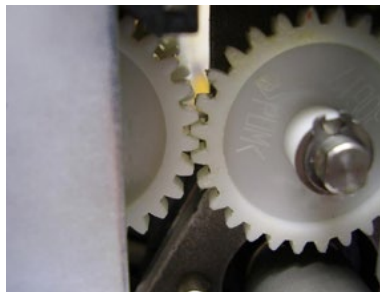

Figure 5 - Thread Feeder Gears

BERNINA



Figure 6 - Gage Pin

13. Click the Thread Feed Home button in the Stepper menu and ensure that the teeth of both gears do not touch. Adjust the position of the thread feeder PCB as required until gear teeth do not touch. Tighten the screws on the right side of the thread feeder assembly.
14. Adjust the bearing on the color change housing so that the red thread feeder clicker for needle #1 is compressed about 50% from the fully extended position. See Figure 7. Make sure the bearing is also centered left to right on the thread feeder clicker.

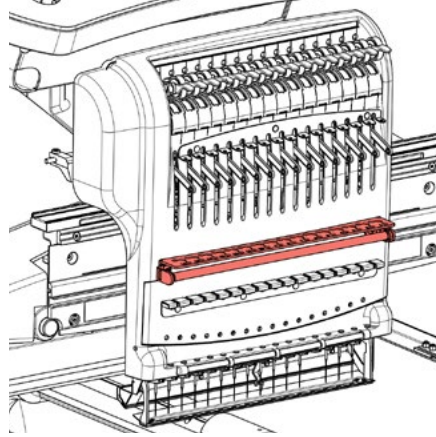

Figure 7 - Thread Feeder Clicker

15. Color change to needle #16. Repeat step 12 and then tighten the two nuts on the left side of the thread feeder assembly.
16. Color change between needle #1 and needle #16 several times to make sure no clicking noise occurs between the gears. Repeat steps 12-15 if necessary to eliminate any gear clicking noise.

Thread Sensor Assembly Replacement

The thread sensor assembly has to be replaced when diagnostic tests indicate it has failed. Symptoms such as inconsistent thread feed, inconsistent thread tension, and an increase in tension can be related errors during embroidery operations.



CAUTION!! Handle the thread sensor assembly carefully. The wiring is extremely fragile to handling. Although this assembly is resistant to electrical static discharge (ESD) damage, use normal precautions when handling electrical components. Parts that are damaged due to mishandling are not covered under the machine warranty.



CAUTION!! DO NOT allow the PCB or bracket to hang by the wires. Support the weight of the PCB during installation or removal.

Replacement Parts Needed:

- Thread Sensor Assembly

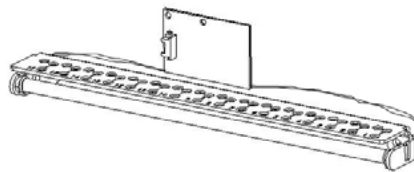

If the assembly is loose, you may want to re-assemble with tape, seating each bracket boss into the thread guide holes.

1. Remove the needlecase access cover.
2. Remove any thread from the needlecase.
3. Remove the needlecase cover.
4. Remove the two M3 nuts mounting the thread sensor PCB to the needlecase and remove the PCB.

BERNINA

5. Use a piece of string or light wire and tie the PCB to the center of the thread sensor base. Do not allow the PCB to hang by the wires that are soldered to it.
6. Remove the two button head screws mounting the thread sensor base to the needle case and remove the thread sensor assembly and base.
7. Avoid handling the thread sensor bar itself and mount the replacement thread sensor assembly and base in the same position as the old one that was previously removed.
8. Mount the base and thread sensor assembly using the two M4x8mm button head socket screws attached to the thread sensor assembly and tighten the screws to the torque specifications.
9. Mount the thread sensor PCB in position with two M3 nuts and tighten to the torque specifications.
10. If there is no other work to be done on the needlecase, reinstall the needlecase cover and the access cover assemblies.

Bobbin Shaft Overhaul

 *This repair requires timing and other adjustments and can only be done by an authorized service technician.*

Bobbin shaft components that might require replacement are the two radial bearings located on the front and back of the machine. The bobbin shaft affects the under thread sewing operations.

Replacement Parts Needed:

- Radial Bearing (order two PN: 30951-05)

When replacing the radial bearings, always replace both of them as a pair.



Figure 1 - Bobbin Shaft Front View

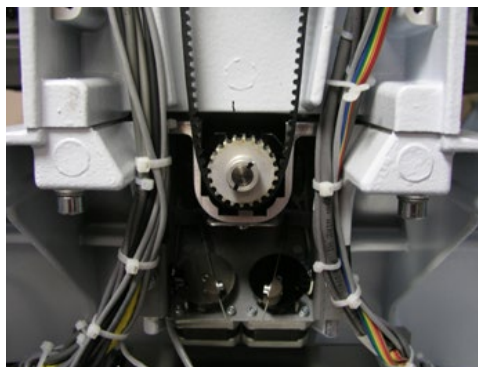

Figure 2 - Bobbin Shaft Timing Pulley (Rear)

Replacement Procedure

1. Remove the needle plate.
2. Remove the rotary hook support.
3. Remove both of the rotary hook guards.
4. Remove the rotary hook.
5. Remove either the left or right arm cover and remove the screw from the back of the other one.

BERNINA

6. Remove the rear upper and lower arm covers.
7. Release the tension from the z-belt by loosening the belt tensioner screw with a 4mm Allen wrench.
8. Remove the timing pulley by punching out the roll pin. The manufacture recommends that the roll pin not be re-used after it has been removed.
9. Remove the snap ring from the front of the bobbin shaft.
10. Tap the bobbin shaft toward the rear of the lower arm casting to release the pressure from the compression spring. Use a rubber mallet or a brass drift so as not to damage the front of the shaft.
11. Replace the compression spring and the rear linear bearing.
12. Replace the timing pulley on the bobbin shaft and make sure that the rear radial bearing is in contact with the pulley.
13. Push the bobbin shaft back into the lower arm until it makes solid contact.
14. While holding the shaft in place, push the front radial bearing onto the shaft and insert the retaining clip. This is usually easier with two people.
15. Install the rotary hook, rotary hook guards, rotary hook support, and the needle plate.
16. Install the z-axis timing belt and tension the z-belt to specifications following the procedures in the Z-Belt Replacement and Tensioning section of this document.
17. Install the rear upper and lower arm covers.
18. Install the arm cover and replace the rear screw on the other one.

Rotary Hook Replacement

Should you need to replace your rotary hook, use the following procedure. This procedure is not to be used to time a rotary hook already installed on the machine.

List of Tools

- Hex Wrench, 2mm
- Hex Wrench, 2.5mm

Replacement Procedure

1. Remove Needle Plate and Hook Guard.
2. Engage the emergency stop
3. Remove rotary hook support finger
4. Rotate Z-axis manually as to have access to all 3 Hook Set Screws
5. Loosen the 3 Hook Fastening Screws (highlighted in red)

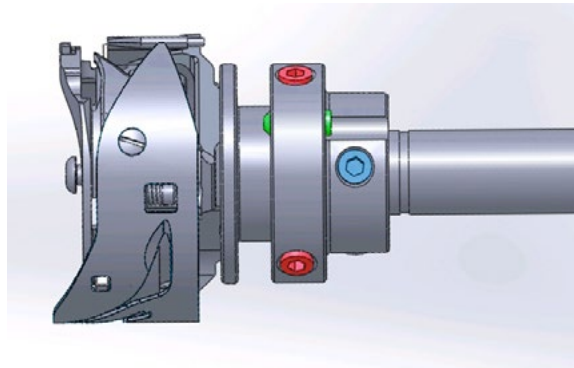

6. Remove the Hook.
7. Install the new rotary hook lining up the notch cut in the rotary hook with the index pin in the hook fastening collar.
8. Put a little bit of pressure with one finger on the hook center and tighten the 3 Hook Set Screws.
9. Position the rotary hook support finger in the hook basket to hold the hook basket in place.

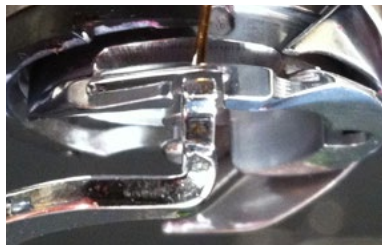

BERNINA

10. While holding the rotary hook support in place, re-install the button head cap screws that you removed previously and loosely tighten both screws.



11. Set the gap between the hook support and the rotary hook using the instructions described in the Rotary Hook Support Adjustment section and fixture P/N 009027-01.



12. Move Z-Axis to 201.5 and check distance to closest needle (see hook timing procedure).
13. Install the needle plate and hook guard.
14. Run Sew test.

Main PCB

CAUTION!! Always observe ESD precautions when handling the main PCB. While the main PCB is resistant to electrostatic discharge, the potential to damage electronic components still exists.

CAUTION!! Do not handle the main PCB without turning the machine off. While the voltage input to the PCB is only approximately 36 volts DC, handling the PCB will short the components out while the PCB is still energized and damage the PCB severely.

Replace the main PCB only after electrical troubleshooting procedures have eliminated other components as the cause of machine failure or the main PCB is obviously defective. This procedure can be safely performed by the customer maintenance personnel as long as required precautions are observed. Before replacing the Main PCB, it is strongly recommended that the situation be discussed with Technical Support as other causes may cause machine failure that looks like a Main PCB fault when it really might be an electrical short in a harness, a software corruption issue, or the like.



Figure 1 - Main PCB Installed

Replacement Parts Required:

- Main PCB

Replacement Procedures:

1. Turn the machine OFF.
2. Let the machine sit without touching the PCB and place your hand somewhere on the machine body (not the Main PCB) to dissipate any residual static in the machine or your body.

CAUTION!! Use extreme care not to drop metallic objects, tools, or other conductive material on the Main PCB when you have the base cover removed. If you drop such objects on the Main PCB, it can severely damage the electronics which will be very expensive to repair.

3. Remove the base cover from the machine.

CAUTION!! Before installing the EMI cover, ensure there is enough slack on all of the harnesses underneath the cover to prevent pinching the harnesses or pulling the connectors loose when the EMI cover is installed. DO NOT force the EMI cover down onto the harnesses.

BERNINA

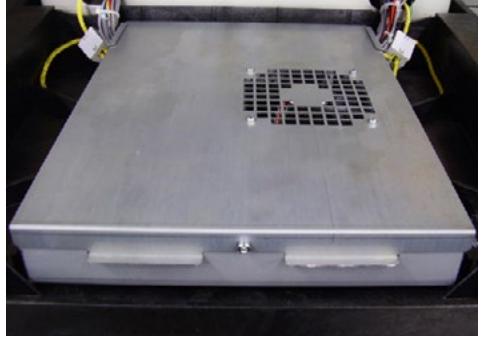

Figure 2 - EMI Cover

4. Remove the EMI cover by loosening the attaching hardware at the front center of the EMI cover. Lift the front of the EMI cover up very slowly and disconnect the cooling fan harness.
5. One at a time disconnect all of the harnesses from the Main PCB and leave the connector in close proximity to the connector socket where you removed it from.
6. Remove the M4 X 8mm flanged socket head screws mounting the Main PCB to the machine base.
7. Remove the Main PCB from the base handling it only by the edges (especially if it is going to be sent to Quality Assurance for failure analysis).
8. Place the old Main PCB in a protective anti-static bag.
9. Remove the replacement Main PCB from the protective anti-static bag it was shipped in, handling it only by the edges and place it in position on the machine base.
10. Install the M4 X 8mm flanged socket head screws and tighten the screws to minimum the torque specifications (only enough to secure the Main PCB in position).
11. One at a time, connect all of the harnesses to their corresponding sockets on the Main PCB.
12. Replace the EMI cover carefully.
13. Turn the machine ON.
14. Go to Tools >> Set Machine Name and S/N.
 - a. Change the machine name from the default to a name of your choosing.
 - b. Change the serial number from 000000 to the serial number of the machine.
 - c. Click on Set >> Next.
15. Go into Tools >> Maintenance >> Calibration tab.
 - a. Click on Set table to send the color change calibration table to the machine. You must click on Set Table 2 times for it to take effect.
16. Conduct machine functional tests to verify that the Main PCB is good.
17. Run the AMPASSXXX test design long enough to ensure that all electronics and motors are functioning. It is not necessary to run the entire design. It is probably sufficient just to run the first two parts of AMPASSXXX (horizontal and vertical columns).

Power Input Assembly Replacement



WARNING!! This procedure is intended to be performed only by specially trained Manufacture service technicians and personnel. Disassembly by untrained individuals will void any warranty protection and can result in personal injury or damage to the machine.



WARNING!! Do not attempt to replace or service any component in the rear of the lower bed without disconnecting the A/C power input cord. Failure to do so will leave the power supply and power switch energized with dangerous levels of voltage even when turned off and can result in severe injury from electrical shock.

The power supply should be replaced when measurements determine that the power output is incorrect or the power supply is not functioning, or when the switch or the wiring between the power switch and power supply unit is defective, burned, or otherwise damaged. For testing of the power supply, refer to Power Supply Test Procedure.

Repair Parts: (Replace/order only damaged or defective parts)

- Power Switch Interface Harness (PN: 301110)
- Power Supply Interface Harness (PN: 301109)
- 360W, 36V, 10AMP, 88-264VAC IN, Power Supply (PN: 31014)
- 8 position in-line coupler (PN: 000434-02)
- 6 AMP, Line Filter, IEC Input Switch w/DPD (PN: 31039)

Not all of the parts in the Power Input Assembly require replacement, nor does the manufacturer recommend replacing all the parts unless they are defective or damaged. If the bulk of the parts in the Power Input Assembly are damaged, it is recommended that you replace the entire assembly. If all you need to do is replace the fuses, do not remove the power input assembly from the machine, otherwise the power input assembly must be removed before working on internal components.

Power Input Assembly Removal:

1. Disconnect the A/C power input cord and the external Ethernet cable from the back of the machine.
2. Remove the lower arm rear cover.



Figure 1 - Power Supply Ground Wires

BERNINA

3. Disconnect the two ground wires (marked P.E., one connected to the back of the power switch and the other to the terminal board on the side of the power supply unit) from the back of the machine body.

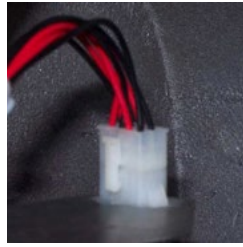

Figure 2 - Power Supply Harness Connection

4. Disconnect the power supply harness from the top of the power supply switch.
5. Remove the four M6x12mm cap head socket screws, M6 split lock washers, and M6 flat washers connecting the power supply mounting bracket to the lower bed body. Two are located to the front of the bracket and two on the bottom close to the rear of the machine.



CAUTION!! Do not disassemble the power input assembly other than to remove the entire unit from the machine.

6. Remove the power input assembly and replace/repair any defective parts.

Power Input Assembly Component Replacement:

In-Line Coupler Replacement



Figure 1 - In-Line Coupler

1. Use a screw driver and push the retaining clip against the coupler body and remove it through the inside of the power supply mounting plate.
2. Replace it with a new in-line coupler by pushing the short side of the coupler into the rectangular hole with the index groove facing to the bottom as shown in Figure 1 above.

Power Supply Replacement



WARNING!! This procedure is intended to be performed only by specially trained Melco service technicians and personnel. Disassembly by untrained individuals will void any warranty protection and can result in personal injury or damage to the machine.

BERNINA



WARNING!! Do not attempt to disassemble the power supply unit for any reason. There are no user serviceable components inside. Internal components in the power supply unit might still have residual voltage (even if power is disconnected) that can cause painful electrical shock.

1. Disconnect the harness wiring from both wiring blocks on the side of the power supply.
2. Remove the four Phillips head screws (w/star) on the bottom of the power input mounting plate that mount the power supply to the plate.
3. Install a new power supply unit and install the screws loose at first, then tighten them to the torque specifications when all four are installed.

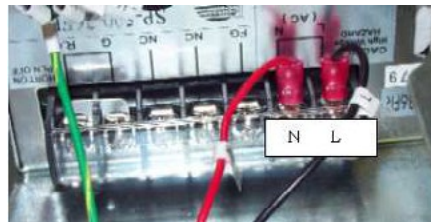

Figure 1 - Bottom Wiring Block (Switch Interface Leads)

4. Attach the ring connectors of the switch interface harness to the power supply wiring blocks as shown in Figure 1 above. Tighten the screws enough to hold them securely but do not over tighten them.

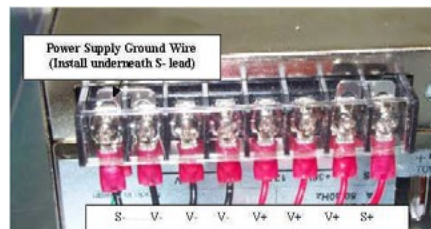

Figure 2 - Top Wiring Block (Wire Leads from Power Interface Harness)

5. Connect the leads of the power supply interface harness (coming from white 8 position connector above switch) to the top wiring block on the side of the power supply as shown in Figure 2 above. The labels shown are also marked with tags on the harness itself. The V+ and V- leads are interchangeable with any of the other leads having the same labeling (V+ or V-).

Power Input Switch Replacement



WARNING!! This procedure is intended to be performed only by specially trained Melco service technicians and personnel. Disassembly by untrained individuals will void any warranty protection and can result in personal injury or damage to the machine.

1. Disconnect the red, black and green wires from the back of the switch.

BERNINA



Figure 1 - Power Input Switch (with fuse)

2. Remove the two black M3x0.5x8mm Phillips screws that mount the switch assembly to the power input assembly mounting plate. The screws have loctite applied so be careful when you remove them to avoid stripping them.
3. Apply red loctite (MS 222) to the screws and install the replacement switch in the position shown in Figure 1 above. Tighten the screws to Melco Torque Specifications.

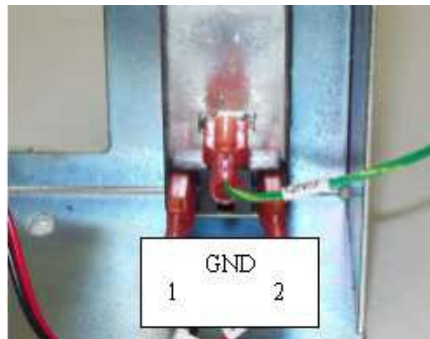

Figure 2 Power Input Switch Wiring

4. Attach the red, black and green connectors from the power switch interface harness and ground cable to the back of the power switch as shown in Figure 2 above. The leads are labeled as indicated by the text below each connection.

Fuse Replacement

Do not remove the power input assembly if all you need to do is replace fuses.



Figure 1 - Fuse Holder

1. With your finger nail or a screwdriver, pry the fuse holder out of the power input switch as shown in Figure 1 above.
2. Either replace both fuses, or use an ohmmeter and verify the continuity on both, replacing the one with little or no continuity. Replace fuses with Time Lag Ceramic Body Cartridge fuses, Rated T5A, 250V (PN: 010162-05). Fuses of equivalent size, capacity and quality can be used.

BERNINA

3. Reinstall the fuse holder in the power input switch assembly by pushing it in until the face of the fuse holder is flush to the face of the switch.

Power Switch Interface Harness Replacement

WARNING!! This procedure is intended to be performed only by specially trained Melco service technicians and personnel. Disassembly by untrained individuals will void any warranty protection and can result in personal injury or damage to the machine.

WARNING!! Do not attempt to replace or service any component in the rear of the lower bed without disconnecting the A/C power input cord. Failure to do so will leave the power supply and power switch energized with dangerous levels of voltage even when turned off and can result in severe injury from electrical shock.

1. Disconnect the leads from the power switch interface harness from the bottom wiring block of the power supply unit and the back of the switch.

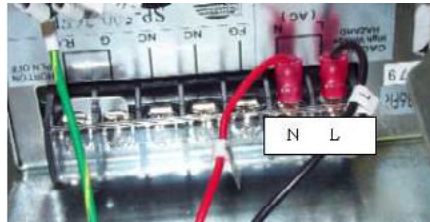

Figure 1 - Power Switch Interface Harness Wiring to Power Supply

2. Install the replacement harness to the bottom wiring block as shown in Figure 1 above. Tighten the screws in the wiring block just enough to hold the wire connectors securely.

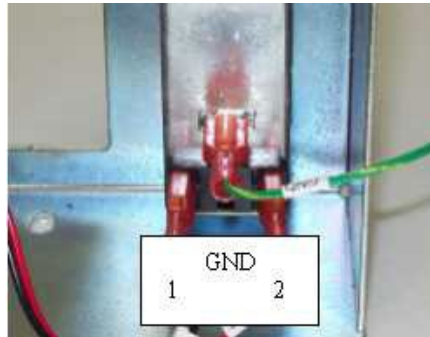

Figure 2 - Power Switch Interface Harness Wiring to Switch

3. Connect the red wire connectors on the replacement harness to the back of the power input switch as shown in Figure 2 above. The labeling of the leads should be identical to the text in the above picture.

BERNINA

Power Supply Interface Harness Replacement

WARNING!! This procedure is intended to be performed only by specially trained Melco service technicians and personnel. Disassembly by untrained individuals will void any warranty protection and can result in personal injury or damage to the machine.

WARNING!! Do not attempt to replace or service any component in the rear of the lower bed without disconnecting the A/C power input cord. Failure to do so will leave the power supply and power switch energized with dangerous levels of voltage even when turned off and can result in severe injury from electrical shock.

1. Disconnect the leads from the power supply interface harness from the top wiring block of the power supply unit.

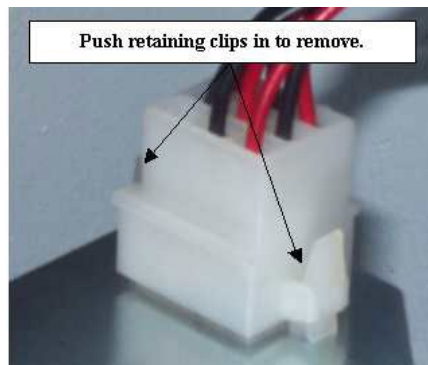

Figure 1 - Power Supply Interface Connector

2. Use a screwdriver or similar tool and push the retaining clips in and push the white 9-position connector out of the power input assembly plate as shown in Figure 1 above.
3. Push the replacement interface harness connector in place in the same position as shown in Figure 1 above.

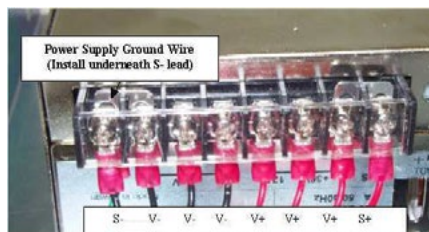

Figure 2 - Power Supply Interface Harness Wiring to Power Supply

4. Install the replacement harness to the top wiring block as shown in Figure 1 above. The V- and V+ leads are interchangeable with like labeled V- and V+ leads. Tighten the screws in the wiring block just enough to hold the wire connectors securely.

Power Input Assembly Installation:

1. Install the four M6x12mm cap head socket screws, M6 split lock washers, and M6 flat washers and connect the power input assembly mounting plate to the inside of the lower bed machine body. Tighten the screws to the torque specifications.
2. Connect the ground wire from the power switch terminal block and the terminal block on the side of the power supply unit to the back of the machine body as shown in Figure 1.
3. Connect the power supply harness to the connector on the top of the power switch bracket.
4. Install the lower bed rear cover and tighten the screws to the torque specifications.
5. Connect the A/C power input cord to the power input connector on the back of the machine.
6. Turn the power switch ON.
7. Verify that the power supply is fully functional using the procedures defined in Power Supply Test.

User Interface Assembly Replacement

i *The user interface assembly has no user or field serviceable parts inside. DO NOT disassemble the user interface assembly if it is to be sent back as a warranty part return.*

Repair Parts Needed:

- User Interface Assembly

Replacement Procedure

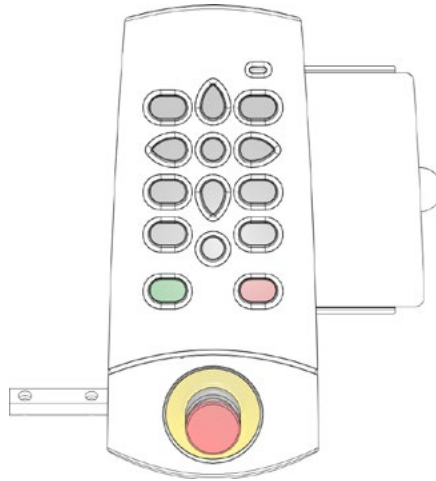

Figure 1 - User Interface

1. Turn the machine ON and then start the software.

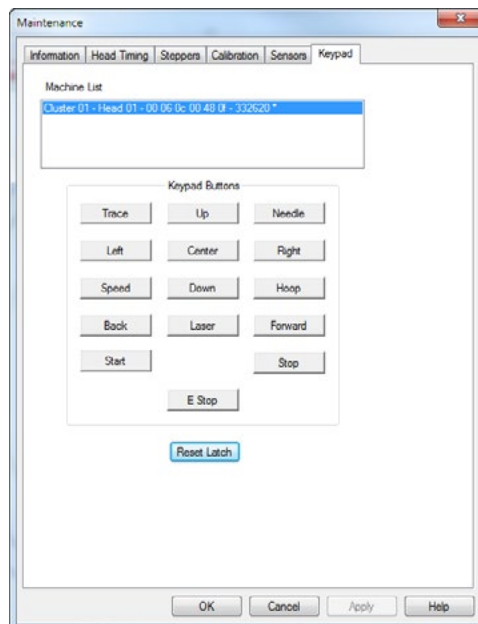

Figure 2 - Keypad Submenu

BERNINA

2. Click on “Tools>Maintenance” and then on the “Keypad” tab in the Maintenance Menu screen. This immediately puts the machine in the test mode, purely for testing the keypad communications. Pressing any of the keys will not affect the machine in any manner until you press the “Reset Keypad Latch” command button on the “Keypad” Submenu screen.
3. One at a time press each key on the keypad. If the keypad is working properly and communicating to the software and the main PCB, the corresponding key on the screen will turn purple while the key is pressed on the user interface panel. When the key is released, the corresponding key on the Keypad Submenu screen will return to normal color, but the font will change color. This indicates that key has been tested and passed the functional test.



Before replacing the user interface assembly, inspect the user interface harness. Make sure both ends of the harness is properly connected and that the harness is not kinked, cut, or pinched. If so, replace the harness first and then conduct tests on the user interface and determine if you really need to replace the user interface.

4. If any of the keys is defective, the entire user interface assembly must be replaced as a whole unit (do not disassemble it).



CAUTION!! *Turn the machine off before disconnecting the keyboard harness from the user interface. Failure to do so might result in internal damage of machine components.*

5. Turn the machine OFF.



Figure 2 - Keyboard Harness Connection

6. Disconnect the keyboard harness from the back of the user interface.
7. Remove the M6 lock nut, 6.2 ID X 18 OD X 0.7 Thick Spring Washers (2 of them), and the 20mm OD X 10mm ID D-Cut Washer from the right side of the user interface mounting bracket.
8. Slide the user interface assembly off the user interface mounting bolt.
9. If the other D-Cut washer or the spring washers stick to the left side of the user interface mounting bracket, remove it and put it back onto the user interface mounting bolt. Replace the spring washers if they have been over torqued and flattened out.
10. Slide the replacement user interface assembly onto the user interface mounting bolt and install the following hardware on the user interface mounting bolt in the order listed:
 - a. one 20mm OD X 10mm ID D-Cut Washer
 - b. two 6.2 ID X 18 OD X 0.7 Thk Spring Washers

BERNINA

c. M6 lock nut

11. Tighten the hex nut just enough so that the user interface stays in position, yet it can be adjusted by hand up and down easily.
12. Connect the keyboard harness to the socket in the back of the user interface panel.
13. Turn the machine ON.
14. Repeat the keypad test described in paragraphs 2 through 4 and verify that the user interface is fully functional. If you have difficulty in installation or should the problem still persist after completing the above procedures, contact Technical Support for assistance.

Harnesses

The replacement procedures are broken down for each individual harness. To retrieve the replacement procedure, click on the appropriate link provided at the bottom of this page. To service any harness that is not provided in this manual, contact Technical Support. Such harnesses are usually not a user or field serviceable item.

Before attempting to replace a harness it is important that you first use the electrical troubleshooting procedures provided in this manual to positively identify the harnesses as probable cause of the machine failure. Replacing a harness represents a significant amount of work and might result in unneeded repair costs if the wrong component is replaced (i.e., a harness rather than a motor, or sensor, etc). Harnesses will generally be one of the last components in a particular circuit to fail. When they do fail, the usual cause is likely to be due to handling during repair and maintenance procedures, especially not allowing adequate slack when installing harnesses or letting harnesses contact moving parts. If harnesses are not bundled with twist-lock cable ties or routed correctly, there is a possibility that they may rub against or get caught in moving parts.



WARNING!! Always turn the power off before disconnecting or connecting any harness. At the minimum engage the emergency stop button by pressing in on the user interface.



CAUTION!! As with any electrical component, always observe ESD safety procedures before handling any internal electrical components.



CAUTION!! Use extreme care not to drop metallic objects, tools, or other conductive material on the Main PCB when you have the base cover removed. If you drop such objects on the Main PCB, it can severely damage the electronics which will be very expensive to repair.

When a harness is replaced, always run a short functional test on the components affected by the individual harness and run a test design (appropriate to the harness you replace) on the machine.

Always route the harnesses explicitly according to the instructions provided for installing each harness. If you route a harness incorrectly, you might end up with too much slack remaining on the other end of the harness or you might have a harness that seems to be too short. Always start the harness from the end farthest away from the Main PCB (the end that connects to the applicable component such as a sensor or a motor). Doing it this way will allow you to conceal extra slack in the harnesses inside the machine base and away from any moving parts. Always securely tie the harnesses using twist-lock plastic cable ties as specified in the installation instructions for each harness. Reuse the twist-lock cable ties when you remove them from the harnesses.

Color Change Motor Harness

The color change motor harness connects the color change actuator assembly (stepper motor) to the main PCB at connector location "CC Motor".



CAUTION!! Do not pull on the wires in the connectors. They will pull out or break if you do. When disconnecting the harness, handle and disconnect the connectors only.

Replacement Part Needed:

- harness, color change motor
- 6-11" cable ties (available at any hardware store in the electrical department)

Replacement Procedures:

1. Turn the machine ON.
2. Color change to Needle #16
3. Turn the machine OFF.
4. Remove the right arm cover and the back screw of the left.
5. Remove the upper arm back cover.
6. Remove the lower arm rear cover.



CAUTION!! Use extreme care not to drop metallic objects, tools, or other conductive material on the Main PCB when you have the base cover removed. If you drop such objects on the Main PCB, it can severely damage the electronics which will be very expensive to repair.

7. Remove the base cover.



Figure 1 - Color Change Harness Connection to Motor

8. Disconnect the color change harness from the color change actuator interface cable.
9. From the back side, pull the color change harness from under the thread tree base. Remove any twist-lock wire ties that tie the harness to adjacent ones.

BERNINA



Figure 2 - Right Wire Channel

10. Pull the color change harness to the back of the machine out of the right wire channel, removing any twist-lock cable ties that connect the harness to adjacent ones.



Figure 3 - Harnessing Routed Under Y-Motor

11. Pull the color change harness from under the y-motor, removing any twist-lock cable ties that connect it to the adjacent harnesses.



Figure 4 - Wire Access Hole

12. Pull the color change harness to the rear from the right access hole in the lower arm body, removing any twist-lock cable ties that tie the harness to the adjacent ones.
13. Run the color change motor lead end of the replacement harness underneath the thread tree base from the right wire channel and pull the harness through until about 3 inches extend from the front of the thread tree base. Connect the color change harness to the color change actuator interface cable.
14. Apply a single twist-lock cable tie in front of the thread tree base to all of the harnesses that run underneath the thread tree base and neatly bundle them together.
15. At the back side of the thread tree base, apply a twist-lock cable tie on the harnesses and bundle them neatly together.
16. Pull the harnesses that run from the back side of the thread tree base towards the right channel and tie all of them to the adjacent harnesses that run into the right wire channel.
17. Run the harness in the right wire channel all the way to the y-motor area, run it between the y-motor mounting bracket and the y-motor. Use a twist-lock cable tie to bundle the harnesses together at both sides of the motor.
18. Remove the EMI cover from the main PCB.

BERNINA

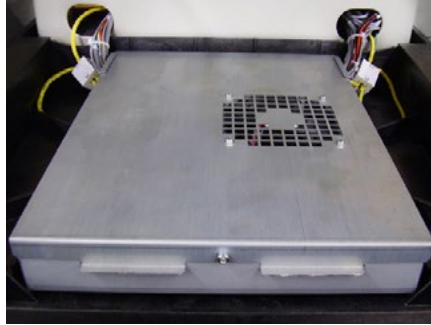

19. Run the color change harness from the back side into the right access hole to the main PCB and connect it at the color change connector socket located at "CC Motor" on the main PCB.
20. Install the covers in the reverse order that you removed them.
21. Turn the machine ON.
22. Do a short functional test and execute several color changes to ensure that the harness is properly connected and works properly.

Ethernet Harness

The Ethernet harness connects the user interface (keyboard) to the Main PCB at connector location "Eth".



CAUTION!! Do not confuse the user interface harness with the similar looking Ethernet harness. The user interface harness connects to "Keypad" on the Main PCB while the Ethernet harness connects to "Eth". Both connectors are the same type, so make sure you are connecting to the correct connector.

Failure of the Ethernet harness will generally be caused from handling of the harness during other repairs or maintenance. It should rarely fail on its own without being handled.

Replacement Parts Needed:

- harness, Ethernet
- twist-lock cable ties (available at most hardware stores in the electrical section)

Replacement Procedures:

1. Turn the machine off.



CAUTION!! Use extreme care not to drop metallic objects, tools, or other conductive material on the Main PCB when you have the base cover removed. If you drop such objects on the Main PCB, it can severely damage the electronics which will be very expensive to repair.

2. Remove the base cover and the lower arm rear cover.

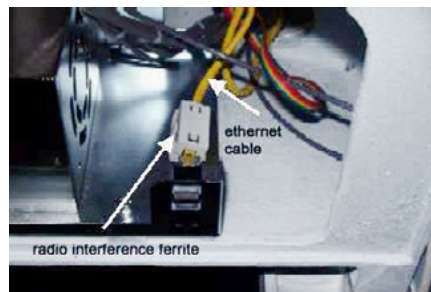

Figure 1 - Ethernet Harness Connected to Coupler

3. Remove any twist-lock cable ties that tie the Ethernet harness to adjacent ones and disconnect it from the back of the Ethernet coupler mounted on the power input assembly plate on the left

BERNINA

rear section and from the main PCB at connector location "Eth". You also need to remove the radio interference ferrite.

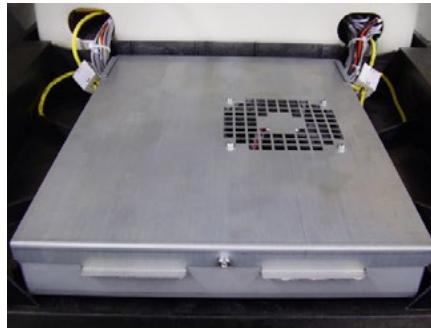

Figure 2 - EMI Cover over Main Board

4. Remove the EMI cover from the main control board.



Figure 3 - Ethernet Connector Location on Main PCB ("Eth")

5. Remove the old Ethernet harness.
6. Connect the replacement harness to the main PCB at connector location "Eth".
7. Replace the EMI cover carefully.

i *Note: Make sure that you replace radio interference ferrite exactly as shown in the instructions for the appropriate EMI cover.*

8. Connect the other end of the Ethernet harness to the back of the Ethernet coupler on the power input assembly plate and coil any excess length in back of the coupler as shown in Figure 1.

i *Note: Make sure that you replace radio interference ferrite exactly as shown in Figure 1.*

9. Replace the twist-lock cable ties on the harness tying it to adjacent ones.
10. Reinstall the rear covers and tighten the screws to the torque specifications.
11. Turn the machine on and load the BERNINA E16 OS.
12. If the software shows the machine being connected, the Ethernet harness and the circuitry on the main PCB is working correctly.

Grabber/Threadfeed Motor Harness

The grabber/threadfeed motor harness connects the grabber and thread feed stepper motors to the connector socket at location "Grabber/ThrFeed" on the main PCB. The grabber/threadfeed motor harness has two leads coming off of it, one labeled "THREAD FEED MOTOR" and the other labeled "GRABBER MOTOR". These leads connect to the interface cables coming off the respective stepper motors.

Replacement Parts Needed:

- harness, grabber/threadfeed
- twist-lock cable ties (available from most hardware stores in the electrical section)

Replacement Procedures:

1. Turn the machine on.
2. Color change to Needle 1.
3. Turn the machine OFF.



CAUTION!! Use extreme care not to drop metallic objects, tools, or other conductive material on the Main PCB when you have the base cover removed. If you drop such objects on the Main PCB, it can severely damage the electronics which will be very expensive to repair.

4. Remove the right arm cover, base cover, upper arm back cover, and lower arm rear cover.
5. Cut any cable ties bundling the grabber motor lead behind the left side of the needlecase assembly.



CAUTION!! When disconnecting the harness leads, grab the connectors. Do not pull on the wires. You will damage the harness if you do.



Figure 1 - Grabber Motor Lead

6. Disconnect the grabber lead from the grabber motor interface cable.



Figure 2 - Thread Feed Motor Lead

BERNINA

7. On the left side of the needlecase, remove any twist-lock cable ties bundling the thread feed motor lead to adjacent harnesses.
8. Disconnect the thread feed lead from the thread feed stepper motor interface cable.
9. Remove the twist-lock cable tie behind the thread tree that bundles the harness running under it.
10. From the backside, pull the grabber and thread feed motor leads through to the back.
11. Remove any twist-lock cable ties that bundle the grabber/thread feed motor harness to the adjacent harnesses and pull the harness from the wiring channel down to where it enters the access cover towards the main PCB.

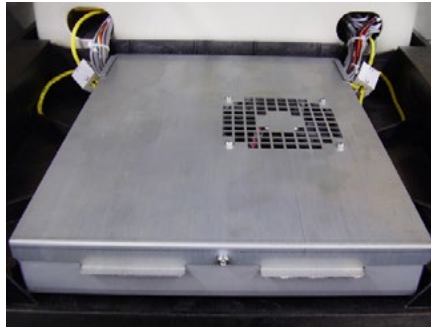

Figure 2 - EMI Cover over Main Board

12. Remove the EMI cover from the main control board.



Figure 4 - Grabber/Thread Feed Motor Connection at PCB

13. Disconnect the grabber/thread feed motor harness from the Main PCB at connector location "Grabber/ThrFeed".
14. Remove any remaining twist-lock cable ties bundling the grabber/thread feed motor harness to adjacent ones and remove it.
15. Run the grabber motor and thread feed motor leads of the replacement grabber/thread feed motor harness under the thread tree base from the right side of the machine.
16. From the front side of the thread tree, split off the two motor leads, and turn them towards the respective motors.

BERNINA

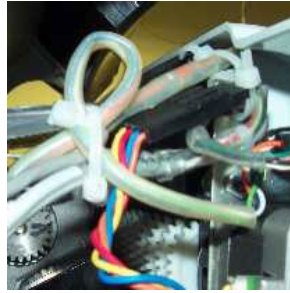

Figure 5 - Harness Tie at Top Left of Needlecase Assembly

17. Connect the grabber motor lead to the interface cable coming off the grabber stepper motor. Loop it and tie it with a cable tie as shown in Figure 4 above. Allow just enough slack so that the connectors will not disconnect during machine operation.
18. Connect the thread feeder motor lead to the interface cable coming off the grabber motor on the right side of the machine.
19. Use a twist-lock cable tie and tie the harnesses running under the thread tree base right at the front and at the back of the base.
20. Run the harnesses running out from under the thread tree base to the right wiring channel and bundle them together with a cable tie at the point where they meet the other harnesses running into the wiring channel.
21. Run the grabber/thread feed motor harness down the right wiring channel following the path of the adjacent harnesses all the way down to the access hole to the Main PCB.
22. Connect the grabber/thread feed motor harness to the connector socket at "Grabber/ThrFeed" on the Main PCB.
23. Replace the EMI Cover.
24. Install the covers in the reverse order that you removed them.
25. Conduct machine functional tests to verify that the harness is good and properly connected (the grabber and thread feed motors function).

Grabber/Threadfeed/CC Home Harness

The grabber/threadfeed/cc home harness connects the grabber home PCB and the threadfeed/cc home PCB to the Main PCB at connector location "G/CC/TF Home".

Replacement Parts Needed:

- harness, grabber/threadfeed/cc home
- Twist Lock cable ties (available at most hardware stores in the electrical section)

Replacement Procedures:

1. Turn the machine OFF.
2. Color change to Needle 1. (To allow access to both home PCBs)
3. Remove the right arm cover and the back screw of the left.



CAUTION!! Use extreme care not to drop metallic objects, tools, or other conductive material on the Main PCB when you have the base cover removed. If you drop such objects on the Main PCB, it can severely damage the electronics which will be very expensive to repair.

4. Remove the base cover, upper arm back cover and the lower arm rear cover.
5. Remove any twist-lock cable ties that bundle the grabber/threadfeed/cc harness to adjacent ones behind the needle case assembly and any cable ties that tie the connectors to the PCBs. Set them aside for re-use.

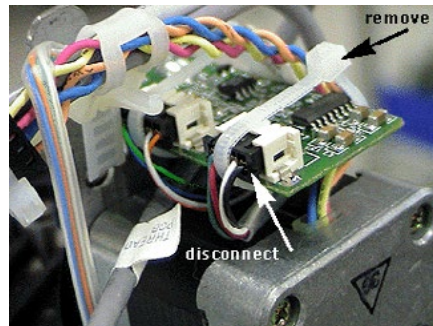

Figure 1 - Grabber Home Harness Lead

6. Disconnect the grabber/threadfeed/cc harness from the grabber home PCB located at the top left behind the needlecase. The grabber/threadfeed/cc harness lead is the four pin connector. The five pin connector is the grabber stepper motor interface cable.

BERNINA

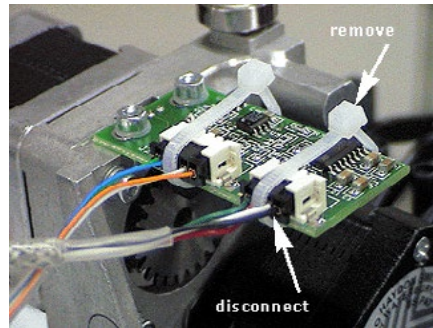

Figure 2 - Thread Feeder Home PCB

7. Disconnect the grabber/threadfeed/cc harness from the thread feeder home PCB located at the top center right behind the needlecase assembly (on the right above the thread feeder stepper motor). The grabber/threadfeed/cc harness threadfeed home lead is the four pin connector identified in Figure 2 above. The five pin connector is for the stepper motor interface cable.

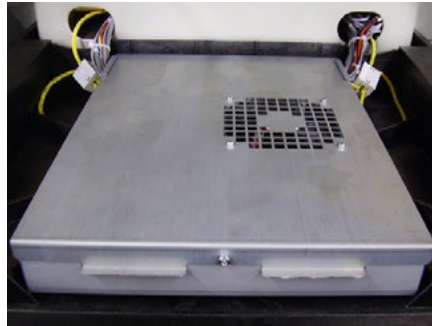

Figure 3

8. Remove any twist-lock cable ties bundling the harnesses together behind the thread tree base and pull the grabber/threadfeed/cc harness from under the thread tree base all the way to the back down to the right lower arm access hole.
9. Remove the EMI cover from the main control.

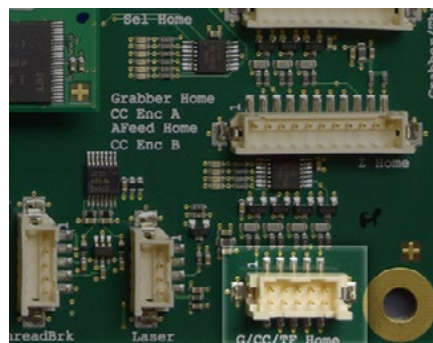

Figure 4 - Grabber/Threadfeed/CC Harness Connection at Main PCB

10. Disconnect the grabber/threadfeed/cc harness from the main PCB at connector location "G/CC/TF Home" and remove any twist-lock cable ties bundling the harnesses together in the base area and remove the harness.

BERNINA

11. Connect the replacement grabber/threadfeed/cc harness leads to the grabber home PCB and threadfeed home PCB as appropriate. The leads are marked "GRABBER HOME/CC POSITION" and "THREAD FEED/CC HOME" respectively to indicate where they are to be connected.
12. Insert the other end of the harness underneath the thread tree base and pull it through from the rear and leave it hanging loose. Provide about 14" length on the grabber/threadfeed/cc harness connector. This end of the harness will travel with the needlecase assembly as it moves left and right.
13. Tie the harness connectors to the PCB with cable ties to prevent them from coming loose during machine operation. Position cable ties between the harness wires on the center of the connector.
14. Run the grabber/threadfeed/cc harness along the same path as the adjacent harnesses, bundling them together with twist-lock cable ties. Add another twist-lock cable tie where they meet together in the right wiring channel of the upper arm.
15. Run the cable through the right wiring channel, down to the right lower arm access hole to the PCB and connect it to the Main PCB at connector location "G/CC/TF Home".
16. Tie the adjacent harnesses together with the grabber/threadfeed/cc harness with cable ties at about 3-4 inch intervals.
17. Replace the EMI Cover carefully.
18. Install the covers in the reverse order that you removed them and tighten the screws to the torque specifications.
19. Run a short machine functional test and verify that the grabber, thread feeder, and color change functions are working properly.

Laser Harness

⚠ WARNING!! *This procedure is intended to be performed only by specially trained and authorized Manufacture service technicians and personnel. Disassembly by untrained individuals will void any warranty protection and can result in personal injury or damage to the machine.*

⚠ WARNING!! *DO NOT allow the laser beam to be aimed at yours or anyone else's eyes. The laser emits a very concentrated light beam that can cause permanent blindness. Use extreme care in handling the laser assembly to make sure it is not going to be inadvertently aimed at someone's eyes or face. DO NOT LOOK DIRECTLY AT THE LASER LENS WHILE IT IS ENERGIZED!*

The laser harness connects the laser pointer assembly to the Main PCB at connector location "Laser".

Replacement Parts Needed:

- harness, laser
- twist-lock cable ties (available at most hardware stores in the electrical section)

Replacement Procedures:

1. Color change to Needle 1.
2. Turn the machine OFF.
3. Remove the right upper arm front cover.
4. Remove the right arm cover and the back screw of the left.

⚠ CAUTION!! *Use extreme care not to drop metallic objects, tools, or other conductive material on the Main PCB when you have the base cover removed. If you drop such objects on the Main PCB, it can severely damage the electronics which will be very expensive to repair.*

5. Remove the base cover, upper arm back cover and lower arm rear cover.

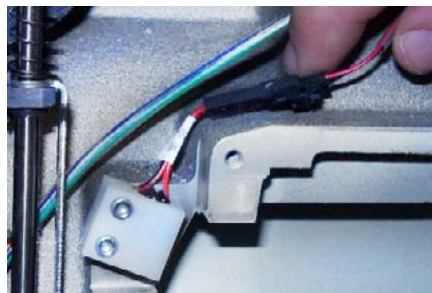

Figure 1 - Laser Harness Connection to Laser Pointer Assembly

BERNINA



CAUTION!! When disconnecting the harness DO NOT pull on the wires. Handle only the connector housings. You will damage the harness if you pull on the wires themselves.

6. Disconnect the laser harness from the laser pointer assembly.



Figure 2 - Right Upper Arm Access Hole

7. From behind the upper arm, pull the laser harness through the right upper arm access hole.
8. Pull the laser harness out the right wiring channel and remove any twist-lock cable ties that bundle the laser harness to adjacent harness, down to the back of the machine.
9. Remove the EMI cover from the main control board.
10. Disconnect the laser harness from the connector at "Laser" on the Main PCB and cut any remaining wire ties that bundle the laser harness to adjacent harnesses.
11. From behind the right upper arm, run the harness lead that is labeled "LASER" through the right upper arm access hole and connect it to the laser pointer assembly as shown in Figure 1.
12. Right behind the right upper arm, pull the unneeded slack out of the harness, and use a twist-lock cable tie to bundle the laser harness to the other two adjacent harnesses that run through the hole.
13. Run the laser harness down to the right wiring channel following the same path as the adjacent harnesses in the channel down to the Main PCB and connect the end labeled "CONTROL PCB LASER - "Laser" " to the connector socket at location "Laser" on the Main PCB.
14. Replace the EMI Cover carefully.
15. Replace all twist-lock cable ties.
16. Install the right upper arm front cover and tighten the screws to the torque specifications.
17. Turn the machine ON.
18. Turn the laser on and off to make sure the laser assembly and harness is working.
19. Install the covers to the machine in the reverse order that you removed them and tighten the screws to the torque specifications.

LED Cluster Harness

There are two led cluster harnesses connecting the LED cluster assemblies to the Main PCB at locations "Light 1/2" (left harness) and "Light 3/4" (right harness). The led cluster harnesses will rarely require replacement at the same time. The usual cause for replacement of either harnesses will likely be due to damage caused in handling the harnesses during repairs and/or maintenance procedures.

Replacement Parts Needed:

- harness, LED cluster
- twist-lock cable ties (available at most hardware stores in the electrical section)

Replacement Procedures:

Left LED Cluster Harness:

1. Turn the machine ON.
2. Color change to Needle 16.
3. Turn the machine OFF.



CAUTION!! Use extreme care not to drop metallic objects, tools, or other conductive material on the Main PCB when you have the base cover removed. If you drop such objects on the Main PCB, it can severely damage the electronics which will be very expensive to repair.

4. Remove the left upper arm front cover, the right arm cover, and the base cover.



Figure 1 - Left LED Cluster Harness

5. Disconnect the LED cluster harness from the left LED cluster assembly.
6. From the back side of the left upper arm, pull the harness through the access hole located just above the x-cable tensioning bracket (Figure 1).

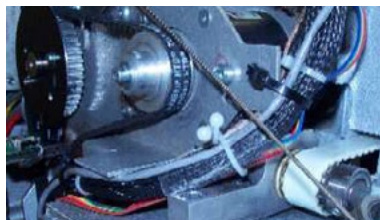

Figure 2 - LED Cluster Harness Tied to Z-Motor Mounting Bracket

BERNINA

7. Pull the harness through the left to the back of the machine and remove the twist-lock cable tie from the z-motor mounting bracket.



Figure 3 - Left Lower Arm Access Hole

8. Remove any twist-lock cable ties from the left LED cluster harness and pull it through the left wiring access hole in the lower arm body to the Main PCB.
9. Remove the EMI Cover from the main control board.

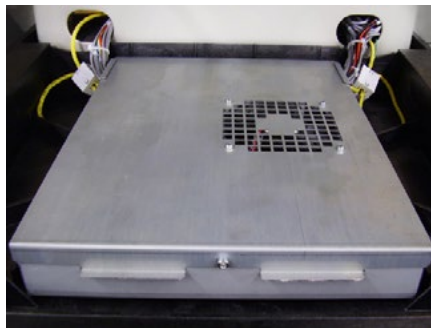

Figure 4 - EMI Cover over Main Board

10. Remove the wire tie from the left and right LED cluster harnesses and disconnect the right LED cluster harness from the Main PCB at connector location "Light 1/2".
11. Connect the new LED cluster harness to the left LED cluster assembly and run it through the z-motor mounting bracket and use a twist-lock cable tie to tie it with the adjacent harnesses to the z-motor mounting bracket (Figure 2).
12. Run the LED cluster harness following the adjacent harnesses down to and through the left lower arm access hole (Figure 3).
13. Run the LED cluster harness through the left lower arm access hole to around the left inside perimeter of the base and connect it to the Main PCB at connector location "Light 1/2".

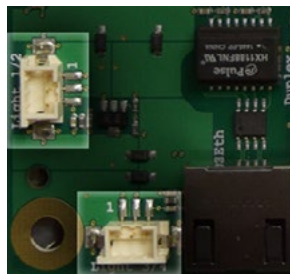

Figure 5 - LED Cluster Harnesses Connected at Main PCB

14. Place the LED cluster harnesses at the main PCB as shown in Figure 5 above.

BERNINA

15. Install the left upper arm front cover and tighten the screws to the torque specifications.
16. Replace the EMI cover carefully.
17. Install the remaining covers in the reverse order that you removed them and tighten the screws to the torque specifications.
18. Turn the machine ON and verify that the LEDs come on in the left LED cluster assembly.

Right LED Cluster Assembly:

1. Turn the machine ON.
2. Color change to Needle 1.
3. Turn the machine OFF.



CAUTION!! Use extreme care not to drop metallic objects, tools, or other conductive material on the Main PCB when you have the base cover removed. If you drop such objects on the Main PCB, it can severely damaged the electronics which will be very expensive to repair.

4. Remove the right upper arm front cover, right upper arm cover and the base cover.



Figure 6 - Right LED Cluster Harness

5. Disconnect the LED cluster harness from the left LED cluster assembly.
6. From the back side of the right upper arm, pull the harness through the access hole located just above the x-cable clamp (Figure 5).
7. Pull the harness through the right access hole to the back of the machine, removing any twist-lock cable ties that tie it to the adjacent harnesses and pull it through the right lower arm access hole.
8. Remove the EMI Cover from the main control board.
9. Remove the right LED cluster harness from adjacent harnesses and disconnect the right LED cluster harness from the Main PCB at connector location "Light 3/4".
10. Connect the new LED cluster harness to the right LED cluster assembly and run it the right upper arm access hole to the back of the machine to the right lower arm access hole.
11. Run the LED cluster harness through the right lower arm access hole to around the left inside perimeter of the base and connect it to the Main PCB at connector location "Light 3/4".

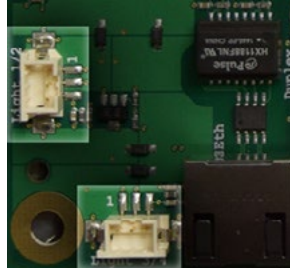

Figure 5 - LED Cluster Harnesses Connected at Main PCB

12. Replace all twist-lock cable ties that were removed from the harnesses.
13. Replace the EMI cover carefully.
14. Install the right upper arm front cover and tighten the screws to the torque specifications.
15. Install the remaining covers in the reverse order that you removed them and tighten the screws to the torque specifications.
16. Turn the machine ON and verify that the LEDs come on in the right LED cluster assembly.

Thread Break Harness

The thread break harness connects the thread break sensor PCB to the Main PCB at connector socket "ThreadBrk".

Replacement Parts Needed:

- harness, thread break
- twist-lock cable ties (available at most hardware stores in the electrical section)

Replacement Procedures:

1. Color change to Needle 1.
2. Remove the needle case access cover and the needle case cover.
3. Remove the right arm cover and the back screw of the left one.



CAUTION!! Use extreme care not to drop metallic objects, tools, or other conductive material on the Main PCB when you have the base cover removed. If you drop such objects on the Main PCB, it can severely damage the electronics which will be very expensive to repair.

4. Remove the upper arm back cover, lower arm rear cover, and base cover.



Figure 1 - Threadbreak Harness Connected to Sensor PCB

5. Disconnect the thread break harness from the thread break sensor PCB.
6. Remove all the twist-lock cable ties that tie it to the adjacent harnesses all the way up to the front of the thread tree base.
7. Remove the twist-lock cable tie that bundles the harnesses behind the thread tree base and pull the thread break harness through from the back of the thread tree base.

BERNINA

8. Pull the harness to the back of the machine, remove any twist-lock cable ties that bundle it to adjacent harnesses, all the way down to the right access hole to the Main PCB.

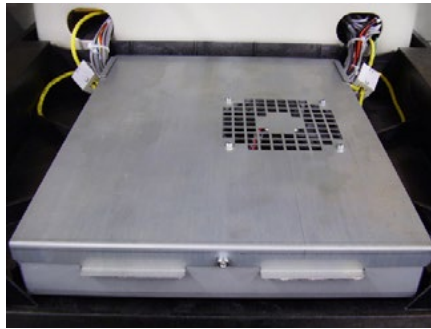

Figure 2 - EMI Cover over Main Board

9. Remove the EMI cover from the main control board.

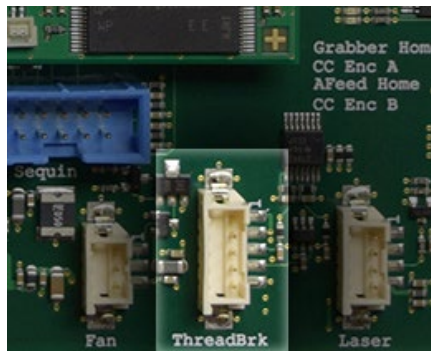

Figure 3 - Connection at Main PCB

10. Disconnect the thread break harness from the connector socket at location "ThreadBrk" on the Main PCB and cut any remaining cable ties bundling the thread break harness to adjacent harnesses. Remove the harness from the machine.
11. Connect the end of the thread break harness labeled "THREAD BREAK SENSOR PCB" to the connector socket on the thread break sensor PCB.

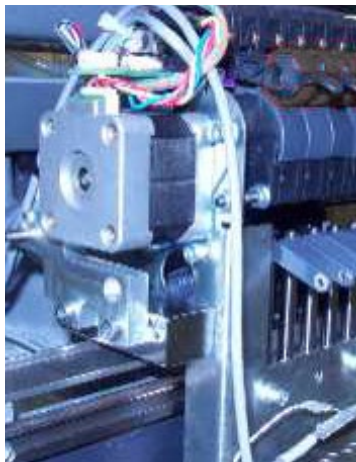

Figure 4 - Routing of Harness to Top of Needlecase

BERNINA

12. Run the harness to the left and then straight up and tie it at the top of the needlecase where the grabber motor harness is bundled. Pinch the harness with your finger to give it a 90 ° bend as shown in Figure 4 above.
13. Use a twist-lock cable tie to tie the thread break harness to the harnesses above the grabber stepper motor and run the other end of the harness under the thread tree base and pull it out from the back.
14. Use twist-lock cable ties and bundle the thread break harness to adjacent harnesses in front of the thread tree base.
15. Tie the harnesses together behind the thread tree base and route the thread break harness with the adjacent harnesses to the right into the right wiring channel and tie them together where they meet the harnesses in the channel.
16. Run the thread break harness down the wiring channel following the path of adjacent harnesses down to the Main PCB and connect it at the connector socket at location "ThreadBrk" on the Main PCB.
17. Replace the EMI cover carefully.
18. Reinstall the covers in the reverse order that you removed them.
19. Run a short functional test to verify that the thread break harness works. (No error message generated by the software indicating a communication break with the thread break sensor PCB.) Deliberately cut the thread where it runs into the thread feeder to see if the thread break sensor PCB detects a thread break.
20. Run the thread break sew test (AMTBTESTXXX) on the machine.

Z Home Harness

The z home harness connects the trimmer home optical sensor and the z-index PCB to the Main PCB at connector location "Z Home".

Replacement Part Needed:

- harness, trimmer/z home
- twist-lock cable ties (available at most hardware stores in the electrical section)

Replacement Procedures:

1. Turn the machine OFF.
2. Remove only the back screws of both upper arm covers.
3. Remove the upper arm back cover and the lower arm rear cover.



CAUTION!! Use extreme care not to drop metallic objects, tools, or other conductive material on the Main PCB when you have the base cover removed. If you drop such objects on the Main PCB, it can severely damage the electronics which will be very expensive to repair.

4. Remove the base cover.
5. Remove any twist-lock cable ties that bundle the trimmer/z home harness to adjacent ones.



Figure 1 - Connection to Z-Index PCB

6. Cut the cable tie at the z-index PCB that holds the connector in the socket (if tied) and disconnect the z-home lead from the z-index PCB.

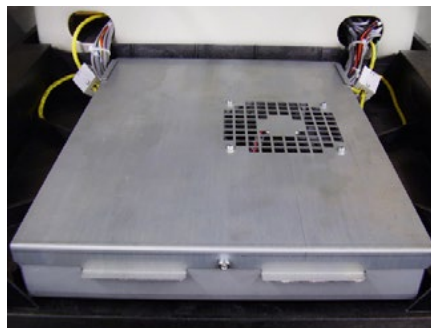

Figure 2 - EMI Cover over Main Board

7. Remove the EMI cover from the main control board.

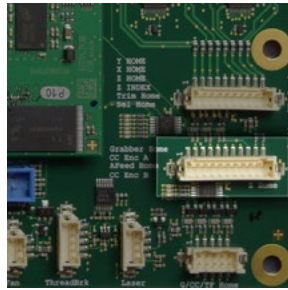

Figure 3 - Connection to Main PCB ("Z Home")

8. Remove any twist-lock cable ties that bundle the trimmer/z home harness to adjacent harnesses in the base area and disconnect the harness from the Main PCB at location "Z Home" and remove the harness.
9. Connect the lead labeled "TRIMMER HOME" of the replacement harness to the trimmer optical sensor interface cable and push the connectors into the lower arm body. Route the trimmer motor and sensor harnesses into the lower cavity of the lower arm.
10. Connect the lead labeled "Z-HOME PCB" to the z-index PCB located right behind the z-index flag.
11. Use small plastic cable ties and tie the connectors snug by attaching the cable tie around the PCB such that the cable tie holds the connector in place. Failure to do this might result in the connectors coming loose which can create difficulties in troubleshooting. (See Figure 1.)
12. Run both leads along the same path as adjacent harnesses and tie them together with twist-lock cable ties and pull the harness through the right lower arm access hole.
13. Connect the harness to the Main PCB at connector location "Z Home" and tie the harness to adjacent ones at 3-4 inch intervals.
14. Carefully install the EMI Cover.
15. Install the covers in the reverse order that you removed them.
16. Turn the machine on.
17. Run a short functional test to ensure both trimmer and z-motors are able to detect their home position.
18. Start the BERNINA E16 OS.
19. Click on the "Tools>Maintenance" menu from the BERNINA E16 OS main menu, and then on the "Head Timing" menu tab.
20. Click on the "Z Index" button. If the software detects "Z-index" (same as Z-home) then no related error message will be reported by the BERNINA E16 OS software.
21. Click on the "Steppers" menu tab, and then on the "Home" button under the "Trimmer" column. If the trimmer detects home, then no related error message will be reported by the BERNINA E16 OS software.
22. If you receive no error messages on steps 19 and 20 above, the harness is good.

User Interface Harness

The User Interface harness connects the user interface (keyboard) to the Main PCB at connector location "Keypad".



CAUTION!! Do not confuse the user interface harness with the similar looking Ethernet harness. The user interface harness connects to "Keypad" on the Main PCB while the Ethernet harness connects to "Eth". Both connectors are the same type, so make sure you are connecting to the correct connector.

Failure of the User Interface harness will generally be caused from handling of the harness during other repairs or maintenance. It should rarely fail on its own without being handled.

Replacement Parts Needed:

- harness, User Interface
- twist-lock cable ties (available at most hardware stores in the electrical section)

Replacement Procedures:

1. Turn the machine off.



CAUTION!! Use extreme care not to drop metallic objects, tools, or other conductive material on the Main PCB when you have the base cover removed. If you drop such objects on the Main PCB, it can severely damage the electronics which will be very expensive to repair.

2. Remove the right plastic side cover, base cover, lower arm rear cover and the upper arm rear cover.



Figure 1 - User Interface Harness Connection

3. Disconnect the user interface harness from the user interface assembly, shown in Figure 1.
4. From behind the upper arm, pull the user interface harness through the right upper arm access hole.
5. Pull the user interface harness out the right wiring channel and remove any twist-lock cable ties that bundle the user interface harness to adjacent harnesses, down to the back of the machine.

BERNINA

6. Remove the EMI cover from the main control board.

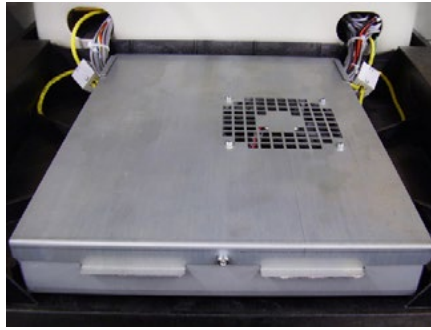

Figure 2 - EMI Cover over Main Board

7. Remove any twist-lock cable ties that tie the User Interface harness to adjacent ones and disconnect it from the main PCB at connector location "Keypad".
8. Remove the old User Interface harness.

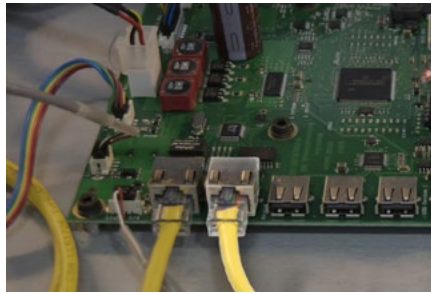

Figure 3 - User Interface Harness in PCB

9. Connect the replacement harness to the main PCB at connector location "Keypad".

 *Note: Make sure that you fold the harness as indicated in Figure 3.*

10. Replace the EMI cover carefully.
11. Run the User Interface harness through the right wiring channel following the same path as the adjacent harnesses.
12. Connect the other end of the User Interface harness to the back of the User Interface assembly as shown in Figure 1.
13. Replace the twist-lock cable ties on the harness tying it to adjacent ones.
14. Replace the base cover.
15. Reinstall the rear covers and tighten the screws to the torque specifications.
16. Replace the right upper arm cover.
17. Turn the machine on and load the software.
18. If the software shows the machine being connected, the User interface harness and the circuitry on the main PCB is working correctly.

X/Y Home Harness

The x/y home harness (rainbow colored ribbon cable) connects the x/y home PCB to the Main PCB at connector location "X/Y Home".

Replacement Parts Needed:

- harness, x/y home
- twist-lock cable ties (available at most hardware stores in the electrical section)

Replacement Procedures:

1. Turn the machine OFF.
2. Remove the left arm cover and the back screw of the right one.



CAUTION!! Use extreme care not to drop metallic objects, tools, or other conductive material on the Main PCB when you have the base cover removed. If you drop such objects on the Main PCB, it can severely damage the electronics which will be very expensive to repair.

3. Remove the upper arm back cover, the base cover and the lower arm rear cover.

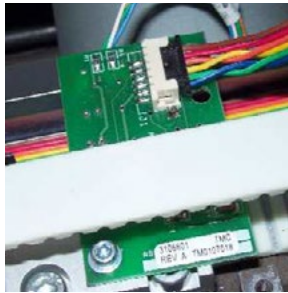

Figure 1 - Connection at X/Y Home PCB

4. Disconnect the x/y home harness from the x/y home PCB (mounted to the left y-belt clamp).



Figure 2 - Retaining Clip in Channel of Y-Home Flag

5. Gently pry the retaining clip out of the channel in the y-home flag, being careful not to damage the x/y home harness any further.



Figure 3 - X/Y Home Harness Access Hole

BERNINA

6. Remove the x/y home harness from the y-home flag channel and pull it through the 1/2 inch diameter access hole in the casting right above the y-home flag channel.
7. Pull the harness down to the left lower arm access hole to the main PCB, removing any twist-lock cable ties that tie it to the adjacent harnesses.

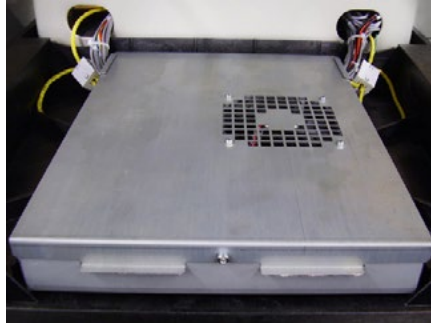

Figure4 - EMI Cover over Main Board

8. Remove the EMI cover from the main control board.

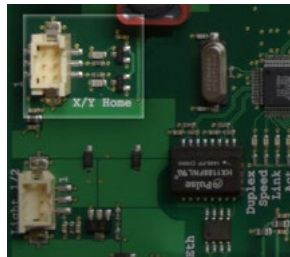

Figure 5 - X/Y Harness Connected at Main PCB ("X/Y Home")

9. Disconnect the harness from the Main PCB at connector location "X/Y Home".
10. Connect the replacement harness to the connector socket on the main PCB at connector location "X/Y Home". This harness is assembled backwards to the other harnesses in that the extra slack is at the sensor end, instead of in the base assembly.
11. Run the harness around the left perimeter of the base interior and out the left access hole. Replace a twist-lock cable tie to bundle all the harnesses together in front of the access hole.
12. Follow the adjacent harnesses running up to the z-motor and tie the x/y home harness to the adjacent harnesses in 3-4 inch intervals up to where it runs under the z-motor.
13. Run the harness flat and neat down the channel in the y home flag and connect the harness to the y home flag. If there is a twist, correct it all the way to the z-motor so that no twist of the harness is in the length from the z-motor area to the PCB.
14. Replace the EMI cover carefully.
15. Reinstall the remaining covers in the reverse order that you removed them and tighten the screws to the torque specifications.
16. Turn the machine ON.
17. If there is any problem with the harness, you will have received an error as soon as the machine initialized because it won't find home. No further testing is required.

Bearing Block Assemblies

i *This repair requires timing and other adjustments and should be done only by an authorized service technician.*

The bearing block assemblies would require replacement if they are damaged or if the sinterbronze bearings that are inside the block slip loose. The sinterbronze bearings are impregnated with oil and in the center is a y-guide felt that is soaked with oil at the factory when the bearing block is assembled.

! **CAUTION!!** *DO NOT apply grease to the y-rails. Grease will damage the bearings in the bearing block assemblies.*

! **CAUTION!!** *DO NOT attempt to disassemble or rebuild the bearing block assemblies. The internal bearings are impregnated with lubricant and are easily damaged if improper tools and procedures are used for assembly.*

! **CAUTION!!** *Never allow the internal impregnated sinterbronze bearings to come into contact with an absorbtive surface. Doing so will damage the bearings.*

Replacement Parts Needed:

- left bearing block assembly
- right bearing block assembly
- sewing machine oil

i *Note: If you replace one of the bearing block assemblies, it is recommended that you always replace both of them as a pair.*

Replacement Procedures:



Figure 1 - Bearing Block Assemblies

1. Remove the hoop and both hoop arm assemblies (if installed).
2. Color change to Needle #16.
3. Remove the left upper arm front cover.

BERNINA

4. Remove both left and right upper arm covers.
5. Loosen the tension on the x-cable at the cable tensioner bracket located on the left upper arm front section.
6. Remove the cable from the pulleys that are attached to the right bearing block assembly.
7. Remove the button head socket screws mounting the right bearing block assembly to the beam.

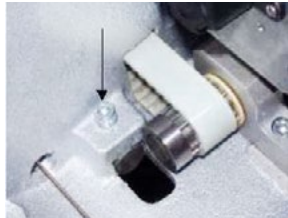

Figure 2 - Y-Rail Retaining Screw

8. Loosen the cap head socket screw retaining the y-rail in the upper arm body.
9. Slide the y-rail out towards the back of the machine until you can slide the right bearing block assembly off, then slide the bearing block off the rail.
10. Wipe the y-rail clean with a rag that is soaked with sewing machine oil.
11. Remove the pulleys from the old bearing block assembly and install them on the replacement block assembly.
12. Slide the bearing block assembly onto the y-rail with the end with two screw holes on the bottom edge facing to the front.
13. Reinstall the y-rail back into position in the upper arm body and tighten the cap head retaining screw to the torque specifications.
14. Apply red loctite (MS 222) to the button head screws and mount the x-beam assembly to the bearing block assembly. Tighten the screws to the torque specifications.
15. Reinstall the cable onto the pulleys on the right bearing block assembly.
16. Repeat the procedures from step 6 to step 15 above for the left bearing block assembly.
17. Add 10 drops of sewing machine oil to the oiling holes located on the top center of the left and right bearing block assemblies.
18. Retention the x-cable using the procedures defined in "X-Cable Tensioning".
19. Reinstall the left and right upper arm covers.
20. Reinstall the left upper arm front cover.
21. Conduct machine functional tests to verify y-axis movements and make sure there are no further obstructions.
22. Conduct a registration sew test using "AMRTESTXXX.EXP" test design and verify that there are no registration issues, especially on the x-axis movements.

X-Beam Assembly

i *This repair requires timing and other adjustments and should be done only by an authorized service technician.*

The only two reasons to remove the x-beam assembly for repair would be if the two steel rails inside the x-beam are damaged because of fretting corrosion due to improper adjustment or lack of lubrication.

Replacement Parts Needed:

(Only if defective - replace them where indicated in the below procedures.)

- X-Beam w/Rails Assembly

Replacement/Repair Procedures:

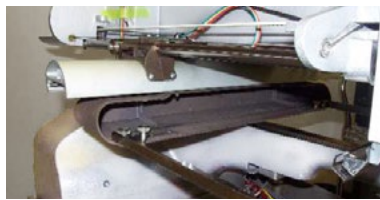

Figure 1 - X-Beam and Carriage Installed on Machine

1. Color change to Needle #16.
2. Turn the machine OFF.
3. If the machine has a hoop installed, remove it from the machine.



Figure 2 - Cable Bracket Removal

4. Remove the two screws holding the cable bracket on the rear of the x-carriage.
5. Remove the cap on either side of the beam and slide the x-carriage out of the beam.
6. Disconnect the x-home sensor optical switch harness from the X/Y home PCB.

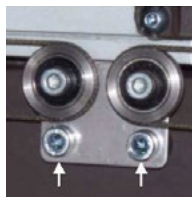

Figure 3 - Bearing Block Assembly Installed on Machine

BERNINA

7. Remove the 3 screws mounting each of the two bearing block assemblies to the top of the x-beam and remove the beam.
8. Apply red loctite (MS222) to the threads of the button head socket screws and reinstall the x-beam assembly to the bearing block assemblies. Tighten the button head socket screws to the torque specifications.
9. Remove the x-home optical switch mounting bracket with the sensor mounted from the old beam and install it in the replacement beam using the installation procedures prescribed in "X-Home Optical Switch Assembly Replacement".
10. Install the end caps on both ends of the x-beam assembly.
11. If you do not have any further work on the machine, reinstall all of the covers in the reverse order that you removed them from the machine.

X-Carriage Assembly

i *This repair requires timing and other adjustments and should be done only by an authorized service technician.*

The only reason for removal of the x-carriage assembly is to replace the bearings, located on top of the carriage, if they are damaged. Damage will usually result from an x-motor fault that causes it to runaway, operator error, or some kind of impact to the x-carriage assembly. When this happens, the bearing might develop some "flat spots" that make the carriage move left or right roughly. Damage can also be caused from fretting corrosion due to misalignment of the bearings or lack of proper lubrication (see "Carriage Rail Lubrication").

i *Note: If corrosion of the carriage rails occurs, the x-beam assembly must be replaced using procedures prescribed in "X-Beam Assembly".*

Replacement Parts:

- two (2) rear straight linear bearing assemblies (PN: 30781-03)
- two (2) front straight linear bearing assemblies (PN: 30782-03)

Removal/Repair Procedures:

i *Note: When the linear bearings are damaged, all of them will usually sustain the same damage. It is recommended that you replace all four bearing assemblies at the same time.*



Figure 1 - X-Beam and Carriage Installed on Machine

1. Turn the machine OFF.
2. If installed, remove the hoop and both hoop arm assemblies.

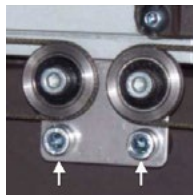

Figure 2 - Remove Two Screws on Cable Pulley Bracket

BERNINA

3. Loosen and remove the two screws holding the cable pulley bracket in the rear center of the x-carriage assembly.
4. Remove the x-beam end cap from the right end of the x-beam.
5. Slide the x-carriage assembly out of the x-beam from the right side of the beam.
6. Remove the damaged straight linear bearings and replace them with new bearing assemblies. Install the bearing nuts and washers and leave the nuts loose until the x-carriage is installed on the x-beam.
7. Slide the x-carriage assembly back into the x-beam assembly.
8. Adjust the front two bearings with an Allen wrench.
 - a. The front bearings have an eccentric stud that is turned counterclockwise to tighten the fit between the two bearing rails permanently installed in the x-beam. This stud is used to adjust the front to back fit of the x-carriage in the beam.
 - b. Tighten the nut on the back bearings just enough to keep the stud in position vertically.
 - c. c. With the Allen wrench, turn the stud counterclockwise until the front to back fit between the two rails is tight (no freeplay) and tighten the nut to the torque specifications. Adjust the carriage so that it moves freely left and right without any resistance, but no freeplay is noticeable when you try to move the carriage front to back in the x-beam.
 - d. CAUTION!! Adjusting the bearings on the carriage accurately to the x-beam is very important. Too much play between the bearings and the rails in the x-beam can result in damage to both components.
 - e. d. Tighten the nuts on the rear bearings to the torque specifications.
 - f. e. Lubricate the rails in the x-beam using the procedures prescribed in "Carriage Rail Lubrication".
9. Install the right x-beam end cap onto the x-beam.
10. Install the cable pulley bracket back onto the rear of the x-carriage assembly with the two cap head socket screws and tighten the screws to the torque specifications (Figure 2).
11. Turn the machine ON.
12. Run a short functional test (about two minutes worth) and verify proper x-axis movements and that the carriage moves left or right smoothly.
13. Run the following sew tests on the machine:
 - AMBTESTXXX.EXP - Belt Tension Test (Circles)
 - AMRTESTXXX.EXP - Registration Test (Diamond)

X-Drive Cable Removal



This repair requires timing and other adjustments and should be done only by an authorized service technician.

The x-drive cable should be replaced when excessive wear and tear or fraying of the cable is noticed. It is critical that the instructions given for the replacement of the x-drive cable be strictly adhered to as improper installation, especially tensioning, of the x-drive cable will lead to failures very difficult to troubleshoot, especially in the x/y registration during embroidery operations.

If you tension the x-drive cable too high, it will cause premature wear on the x-axis servo motor and will cause problems with the x-axis registration. Typically, the symptoms of an x-cable tensioned too high will be narrow stitch length on x-axis stitching.

If you tension the x-drive cable too low, it will cause problems with the cable slipping on the pulleys and increase the amount of time it takes the x-motor to move to specific positions. Typically, the symptoms of an x-cable tensioned too low might be x-move timeouts, x-tracking errors, or stitch length being too long on the x-axis.



CAUTION!! *Use extreme care not to damage the cable and protective coating during assembly. If the protective coating is damaged, the cable will wear out very fast impacting the quality of the sew outs.*



CAUTION!! *At any time when the machine is either powered down or in E-Stop mode, neither the X-carriage nor the X-beam should be moved at a high rate of speed. If there is a desire to manually move either the carriage or the beam, they should be pushed or pulled GENTLY to prevent serious damage to the main control board.*

X-Cable Removal Procedure:

1. Remove the left and right arm covers.
2. Remove the upper arm back cover.
3. Move the x-carriage all the way to the right (as seen from the front of the machine) until it comes to a hard stop. All references to the windings of the x-cable and other adjustments will be based on the x-carriage being positioned all the way to the right at a hard stop.
4. Wrap tape around the windings of the cable on the x-drive cable spool to keep the cable from slipping off the spool and to keep the windings on the spool correct.

BERNINA

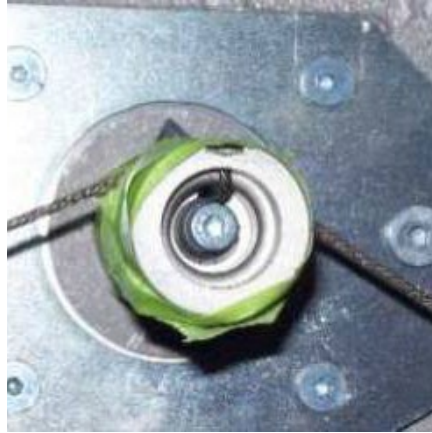



Figure 1 - Cable Tensioner Bracket

5. Start on the left side of the machine and loosen the hex nut on the x-cable tensioning bolt slowly and then remove it. Hold onto the cable as you do this and do not let it drop.
6. Pull the cable through the access hole to the back of the machine body, off all of the pulleys and let it hang loose in the back.
7. Loosen the hex nut on the tensioning bolt on the right side of the machine.
8. Pull the cable through the access hole on the right side of the machine, from around each of the pulleys, and let it hang loose on the backside off the x-drive cable spool.
9. Loosen the screw located at the center of the x-drive cable spool from the back and remove the cable and spool from the machine.
10. If you are going to reinstall the cable later, place it in a secure area to protect it from damage. If you damage the protective coating, the cable will fray and eventually corrode.

X-Drive Cable Installation

 *This repair requires timing and other adjustments and should be done by an authorized service technician.*

When installing the x-drive cable it is extremely important that you do not damage the protective coating of the cable, ensure that the windings on the cable spool are correct, that the cable is correctly tensioned, and the installation is done precisely as provided in these instructions.

When replacing the x-drive cable it is strongly recommended that the x-drive cable assembly be ordered and installed. The precision windings and lengths of the cable extending from the spool is critical and is best done only at the factory.

 **CAUTION!!** *Use extreme care to avoid damaging the protective coating on the x-drive cable. If the coating is damaged, the cable will eventually fray and/or corrode.*

 **CAUTION!!** *At any time when the machine is either powered down or in E-Stop mode, neither the X-Carriage nor the X-Beam should be moved at a high rate of speed. If there is a desire to manually move either the carriage or the beam, they should be pushed or pulled GENTLY to prevent serious damage to the main control board.*

Replacement Parts Needed:

- x-cable assembly (x-cable prewound on spool)
- Order other replacement parts if needed, such as pulleys
- Replacement hardware if any screws or nuts are stripped

X-Cable Assembly Installation:

1. Remove left and right arm covers.
2. Remove the upper arm back cover.
3. Remove the old x-drive cable assembly.
4. Make sure the x-carriage is positioned all the way to the right (as seen from the back of the machine) at a hard stop.
5. Verify the 8mm bushing is installed on the X-motor shaft.

BERNINA

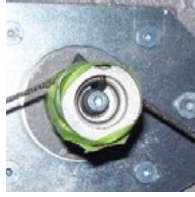

Figure 1 - X-Cable Spool (Taped and Installed)



CAUTION!! DO NOT remove the tape from the x-cable spool when you install it until the cables are tightened up. The cable will become unwound and will be extremely difficult to rewind with the precise lengths needed to install it on the machine.

6. Install the x-cable spool assembly on the x-motor shaft with an 8mm bushing, 5/16IDx.031 THK shaft spacer, four 8mmIDx18mmOD external star washers, one .173IDx.375OD D-Shaped washer, and one M4x10mm cap head socket screw. Tighten the screw to 11 in-lbs (1.2Nm) of torque.



The four external washers are already inside the X-Cable spool assembly. Handle with care to prevent the washers from falling out.

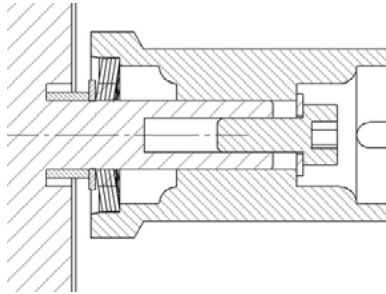

Figure 2 - Assembly Drawing

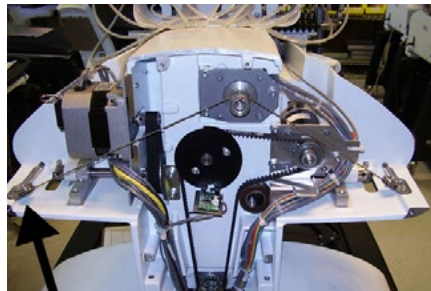

Figure 3 - Right Rear Pulley



Figure 4 - Right Rear Pulley Close Up

BERNINA

7. Run the cable around the pulley shown in Figure 3 and Figure 4.



Figure 5 - Right Beam Cable Pulleys (Arrows indicate direction of cable to the front)

8. Run the cable through the through hole in the back of the upper arm casting to the right rear carriage cable pulley down to the top right beam cable pulley.



Figure 6 - Center Beam Cable Pulley (Arrows indicate direction of cable to the front)

9. Run the cable from the top right beam cable pulley around the right center beam cable pulley to the bottom right beam cable pulley.
10. Run the cable around the bottom right beam pulley (see figure 5), around the right front carriage pulley into the cable access hole to the front of the machine.



Figures 7 - X-Cable Clamp

11. Attach the washer and nut to the threaded end of the stud. Use needle nose pliers to hold the cable stud before tightening the nut to prevent the cable from twisting.



Figure 8 - Left Rear Cable Pulley

12. Run the left cable from the spool around the left rear cable pulley.

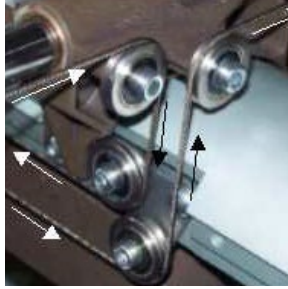

Figure 9 - Left Beam Cable Pulleys

13. Repeat steps 8-10 for the left side cable.



Figure 10 - Cable Tensioning Bracket (Left side of machine)

14. Install the washer and nut to the threaded end of the stud. Use needle nose pliers to hold the cable stud before tightening the nut to prevent the cable from twisting.
15. Tension the x-cable using the procedures prescribed in "X-Cable Tensioning".
16. Install the upper arm back cover.
17. Install the left and right arm covers

X-Drive Motor Replacement

 *This repair requires timing and other adjustments and should be performed by an authorized service technician.*

Besides in case of an x-motor failure, the X-motor assembly should also be replaced when the resistance between each of the phases is inconsistent or substantially different than $3.65 \pm 10\% \Omega$. In addition, the resistance between each of the phase wires should be relatively consistent with the other wires.

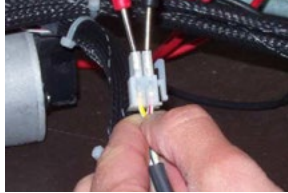

Figure 1 - Measuring Resistance Between Motor Phase Wires

Resistance of the x-motor phase wires can be measured at the connector with an Ohmmeter as shown in Figure 1 above. Disregard the green (ground) wire and measure the resistance between each combination of the other 3 wires.

Measuring resistance however, is not the only factor to be used in determining whether to replace a motor or not. Examples of other issues that should be considered is how freely and smoothly the spindle on the motor turns. These factors are covered in the troubleshooting section of this manual.

Replacement Parts Needed:

- x-axis brushless servo motor
- 6-11 inch Cable Ties (to re-tie the harnesses after installing the new motor) (available at most hardware stores in the electrical section)

Replacement Procedure

1. Turn the machine OFF.
2. Remove the left arm cover and the screw from the back of the right one.
3. Remove the upper arm back cover.

 **CAUTION!!** *Use extreme care not to drop metallic objects, tools, or other conductive material on the Main PCB when you have the base cover removed. If you drop such objects on the Main PCB, it can severely damage the electronics, which can be expensive to repair.*

4. Remove the base cover.
5. Remove the EMI cover.
6. Remove the lower arm rear cover.

BERNINA

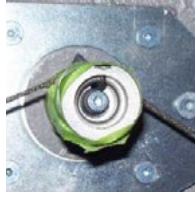

Figure 2 - Wrap Tape Around X-Drive Pulley

i *IMPORTANT!! If the x-cable is not secured to the x-drive pulley it will most likely unwind off the pulley when the latter is disassembled from the X-motor. This results in a longer machine-downtime due to the time it takes to reassemble the cable. The cable must be precisely wound; the correct lengths of the cable extending from the spool are very important to the functioning of the machine.*

! *CAUTION!! DO NOT drop the x-cable spool or allow the star washers that are pressed inside the spool to come loose. These star washers are precision aligned and pressed inside the spool with a fixture at the factory. If the star washers come loose or fall out, replace the x-cable assembly (comes with a spool). Installing a spool with star washers out of position or missing will likely result in damage to the machine.*

7. Wrap some tape around the x-drive pulley to secure the cable to the pulley and prevent it from coming unwound.
8. Remove the left or right upper arm side cover.

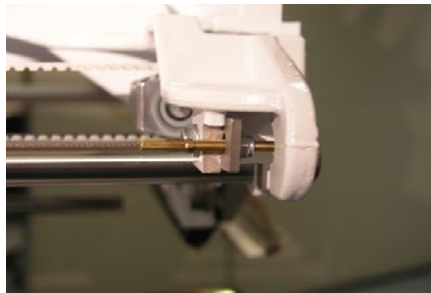

Figure 3 - X-Cable Tensioning Screw

9. Loosen the tension on the x-cable at the x-cable tensioning screw located at the front of the machine on the left side by loosening the nut.
10. Remove the screw mounting the x-cable spool to the motor and remove the spool.

BERNINA

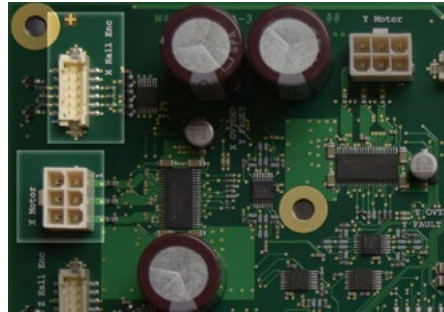

Figure 3 - X-Motor Harness Connections

11. Disconnect the x-harness hall and motor leads (marked "CONTROL PCB X MOTOR" and "CONTROL PCB X HALL/ENC") from the main PCB at locations "X Motor" and "X Hall Enc".
12. Use wire cutters and cut any cable ties tying the x-motor harness leads to any of the other harnesses and pull the x-motor harness through the cable access hole to the lower bed.
13. Cut any cable ties tying the x-harness leads to the z-motor harnesses.

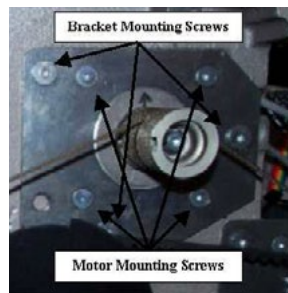

Figure 4 - X-Motor Mounting Screws

14. Remove the X-motor bracket mounting screws and remove the x-motor together with the bracket from the machine.
15. Remove the x-motor bracket from the x-motor and install it on the replacement x-motor and tighten the screws to the torque specifications.
16. Reinstall the x-drive pulley to the x-motor so that the index arrow (marked on the pulley rim when originally installed) is facing straight up and tighten the screw to 8 in-lbs[0.9 Nm] of torque using a torque wrench.
17. Run the x-harness on top of the z-motor harness and along the same path as the z-harness down to the main PCB and tie them together using cable ties about every 3-4 inches.
18. Connect the x-motor harness leads into the main PCB at locations "X Motor" and "X Hall Enc".
19. Tension the x-cable using the procedures provided in X-drive cable installation.
20. Reinstall the left upper arm side cover and tighten the screws.
21. If you do not have any further work on the inside of the machine, install the covers in the reverse that you removed them.

X-Home Optical Switch Assembly Replacement

i This repair requires timing and other adjustments and should be performed by an authorized service technician.

The x-home sensor is installed inside the x-beam. It requires replacement when it gets too dirty or if the cable attached to it is damaged in any manner (chaffing, pinched wires, shorts or breaks). The x-home functionality can be verified by moving the x-carriage right and left and watch the LED on the main PCB at location D37. The LED should come on just as the carriage reaches the "x-home" position and go off when the carriage is moved further left or right.

Replacement Part Needed

- X-home optical switch assembly
- 3.2mm IDx9mm ODx.8mm THK fender washer
- M3x0.5mmx10mmLG cap head socket screw

Replacement Procedures

1. This procedure is done with the machine turned ON. However, engage the emergency stop by pushing it in.

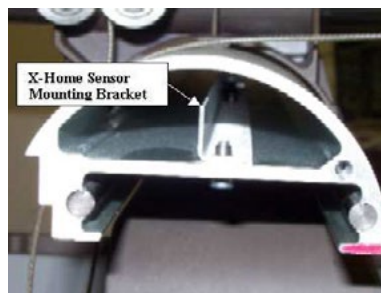

Figure 1 - X-Home Sensor Mounting Bracket

2. Remove the x-beam end cap from the left end of the x-beam.
3. Disconnect the x-home sensor cable from the x-y optical sensor PCB.
4. Move the x-carriage all the way to the right as far as it will go.



Figure 2 - X-Home Sensor and Mounting Screws

5. Remove the screws mounting the x-home sensor mounting bracket to the beam. The screws are located on the bottom side of the beam as shown in Figure 2 above.

BERNINA

6. Slide the x-home sensor mounting bracket out of the beam, carefully pushing the cable through the access hole at the top of the beam. Do not allow the cable to rub on the edge of the access hole as you pull it through.
7. Remove the defective x-home sensor from the mounting bracket.



CAUTION!! DO NOT use loctite on the screw mounting the x-home sensor to the mounting bracket. Loctite is corrosive to plastic and will damage the sensor.



CAUTION!! DO NOT over tighten the screw mounting the optical sensor to the mounting bracket. You will either strip the threads or crack the sensor housing if you do so.

8. Run the x-home sensor into the access hole at the top of the beam and pull it out the end of the beam, mount it to the bracket and tighten the screw just enough to hold the sensor securely.
9. Slide the x-home sensor assembly (sensor and bracket) back into the beam and tighten the two bottom mounting screws just enough to hold the assembly in place.
10. Set x/y home using the procedures prescribed in "X/Y Home Adjustment".

X/Y Home PCB Replacement

 *This repair requires timing and other adjustments and should be performed by an authorized service technician.*

The X-home PCB needs to be replaced when the sensors fail to detect home. This condition normally results when the optical sensors are damaged due to mechanical interferences or incorrect adjustment. Optical sensors should be cleaned only with compressed air. The use of any kind of solvent or cleaning liquid will damage the sensors.

Optical sensors might also be damaged through improper torque of the mounting screws, misalignment of the PCB, or X & Y home flags.



Figure 1 - X/Y Home PCB (Belt turned up for illustration)

 **WARNING!!** *A small risk exists of unpredictable movement of internal parts when the optical sensors are disconnected. This creates a risk of personal injury if parts suddenly move. Always turn off the machine before disconnecting optical sensors.*

Replacement Parts Needed

- X/Y Home PCB

Replacement Procedure

1. Turn the machine OFF.
2. Make contact with a metal part of the machine to dissipate any static build up in your body.

 **CAUTION!!** *Use extreme care not to drop metallic objects, tools, or other conductive material on the Main PCB when you have the base cover removed. If you drop such objects on the Main PCB, it can severely damaged the electronics which will be very expensive to repair.*

3. Remove the base cover, the left arm cover and the back screw from the right arm cover, the upper arm back cover, and the lower arm rear cover.

BERNINA

4. Use a pencil and trace the outline of the X/Y Home PCB on the top of the Y-drive timing belt clamp.
5. Disconnect the harnesses from the PCB connectors and set the harnesses off to the side of where they were disconnected from. Do not get these two harnesses mixed up with each other. Mark them with tape to prevent confusion between the two harnesses.
6. Loosen and remove the two M3x6mm cap head socket screws and M3 flat washers.
7. Remove the X/Y Home PCB and replace it with a new one.
8. Align the replacement PCB to the marks you traced on the Y-drive timing belt clamp.
9. Tighten the screws just enough to hold the PCB securely. Examine the position of the y-home flag between the optical sensors and make sure that the flag is centered and does not hit the sensors. If adjustment is needed, loosen the PCB and move it one way or the other to center the flag and tighten the screws just enough to secure the PCB and recheck the position of the flag again.
10. Tighten the screws to the minimum Torque Specification (10% less than specified for the screws).
11. Turn the machine ON.
12. Install any size hoop with one piece of backing.
13. Select the appropriate size hoop in the BERNINA E16 OS.
14. Measure and mark the center of the hoop by measuring from the left and right and front to back inside border of the hoop. Place an "X" mark on the center location on the backing.
15. Click on the "Commands" menu in the BERNINA E16 OS main menu, and then on the "Set Home" and then center the hoop.
16. Click on "Tools>Maintenance" menu in the BERNINA E16 OS main menu, on the "Head Timing" menu, and then on the "Bottom Center" button.
17. If the needle is off front to back, adjust the X/Y Home PCB from Step 8, moving it in the direction and distance that the needle is off center front to back and tighten the screws to the torque specifications.
18. Reinstall the covers you removed in step 3.

Y-Drive Belt Replacement

The Y-drive belts will wear out and stretch over time. To extend the useful lifetime of these belts, always ensure they are properly tensioned at all times. Incorrect tensioning of the belts will cause them to wear prematurely and might also cause damage to the machine itself.

i *This repair requires timing and other adjustments and should be performed by an authorized service technician.*

i *When replacing y-drive belts, always replace both belts as a pair. Leaving a worn belt on the machine with a new belt installed on the other side can cause both belts to wear prematurely*

! **CAUTION!!** *At any time when the machine is either powered down or in E-Stop mode, neither the X- nor Y-carriage should be moved at a high rate of speed. If there is a desire to manually move either carriage, it should be pushed or pulled GENTLY to prevent serious damage to the main control board.*

Replacement Parts Needed

- Belt, Timing, Open, AT5-16 X 1124 Long (two pieces)

Replacement Procedures

1. Color change to Needle #16.
2. Turn the machine OFF.
3. Remove the left upper arm front cover.
4. Remove both the left and right upper arm covers.

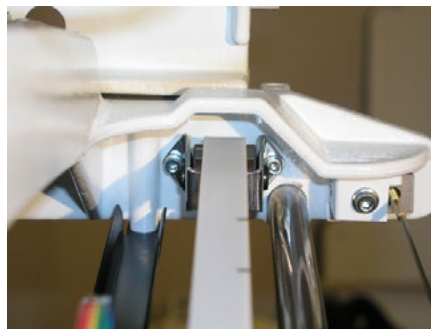

Figure 1 - Y-Drive Belt Adjusting Nuts (Left Side)

5. Loosen the tension on the y-drive belt by loosening the nuts on the idler bearing mounting bracket studs.

BERNINA



Figure 2 - Left Timing Belt Clamp and X/Y Home PCB

6. Remove the x/y home PCB from the y-drive belt clamp. Leave it hanging on the connected harnesses.
7. Remove the timing belt clamp and remove the old belt.
8. Install a replacement belt and pull the ends over the bearing block assembly so that the ends of the belt are no more than one tooth width apart and extend equally underneath the clamp.
9. Install the timing belt clamp and tighten the screws down just enough to hold the belt in position.
10. Tighten the adjusting nuts on the idler pulley studs just until the slack is removed from the belt.
11. Tighten the screws on the belt clamp to the torque specifications.



Figure 3 - Right Y-Drive Timing Belt Clamp

12. Reinstall the x/y home PCB back onto the left timing belt and leave the screws installed loose for now.
13. Adjust the x/y home PCB using the procedures prescribed in "X/Y Home PCB Replacement".
14. Adjust the y-axis timing belt tensions using the procedures prescribed in "Y-Axis Timing Belt Adjustment"
15. Reinstall the left upper arm front cover and tighten the screws to the torque specifications.
16. Color change to Needle #1.
17. Remove the right upper arm front cover.
18. Repeat steps 5 through 16 for the right y-drive timing belt, ignoring any references to the x/y home PCB.
19. Reinstall both the left and right upper arm covers.
20. Double check the x-home and y-home adjustments using the procedures prescribed in "X/Y Home Adjustment".
21. Do a short machine functional test and observe for correct x- and y-axis movement. Make necessary adjustments or additional repairs if needed.
22. Run the following test designs on the machine:
 - AMBTESTXXX.EXP - Belt Tension Test (Circles)
 - AMRTESTXXX.EXP - Registration Test (Diamond)

Y-Motor Assembly

 *This repair requires timing and other adjustments and should be performed by an authorized service technician.*

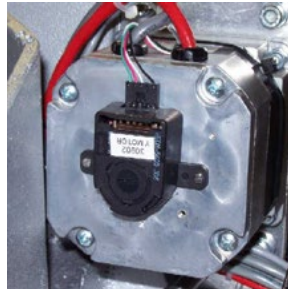



Figure 1 - Y-Motor Installed

Besides the case of a y-motor failure, the y-motor assembly should be replaced when the resistance between each of the phases is inconsistent or substantially different than $2.28 \pm 10\% \Omega$. In addition, the resistance between each of the phase wires should be relatively consistent with the other wires.

Replacement Parts Needed

- y-motor assembly
- 6-inch plastic cable ties (available from any hardware store in the electrical supply section)

Replacement Procedures

 **WARNING!!** *Risk of serious personal injury exists when handling internal motors, belts, and cabling due to electrical shock and moving parts hazards. Always turn off the embroidery machine when working on or adjusting motors, belts or gears.*

1. Turn the machine off and disconnect the A/C wallpower input cord from the A/C wallpower supply outlet.

 **CAUTION!!** *Use extreme care not to drop metallic objects, tools, or other conductive material on the Main PCB when you have the base cover removed. If you drop such objects on the Main PCB, it can severely damaged the electronics which will be very expensive to repair.*

2. Remove the base cover, the left arm cover and the back screw from the right arm cover, the upper arm back cover, and lower arm rear cover.

BERNINA



Figure 2 - Y-Motor Connections at PCB

3. Disconnect the Y-motor harness and y-hall/encoder harness from the Main PCB as shown in Figure 2 above.
4. Carefully cut any cable ties that tie Y-motor and encoder harnesses running underneath the y-motor through the lower arm access hole to the main PCB.
5. Pull the y-motor and encoder harnesses through the access port to the back of the machine and let it hang free.
6. Loosen the three M6x20mm cap head socket screws to loosen the tension on the y-motor pulley, then remove the screws, M6 split lock washers, and M6 flat washers.
7. Pull the y-motor timing belt off of the y-motor timing pulley and let it hang on the drive pulley on the y-drive shaft.
8. Remove the y-motor from the machine. (Do not disassemble the y-motor assembly any further, especially if it is to be returned to the factory.)
9. Install the new y-motor in position and place the y-motor belt over the motor pulley.
10. Start the three M6x20mm cap head socket screws, M6 split lock washers, and M6 flat washers loose.
11. Pull up on the y-motor with about 30 lbs pull and tighten the M6x20mm cap head socket screws to the torque specifications.
12. Measure and reset the y-belt tension if needed. (Click on the link to get the procedures.)
13. Reinstall the covers you removed in step 3.
14. Turn the machine on and run a functional test on the machine, paying particular attention to y-axis movements. Run this test until you are satisfied with the performance of the y-axis movements or you discovered other problems in the test.
15. If the function tests are satisfactory, run the following sew tests on the machine:
 - AMBTTESTXXX.EXP (Belt tension test)
 - AMRTESTXXX.EXP (Registration test)

Troubleshooting

This troubleshooting section is provided for the purpose in assisting you in diagnosing failures and malfunctions of the machine. It is not all inclusive and should be regarded as guidance rather than specification.

Grabber Function Test

The grabber function test will help to isolate mechanical and electrical failures of the grabber assembly. The two errors most likely to occur during this test are:

- Grabber Stepper Index Error - the software is detecting that the grabber is not in a safe position when the needle begins to come down.
- Grabber Timeout Error - the sensors fail to detect home within the allotted amount of time programmed into the firmware and software.

Test Procedures:

1. Inspect the grabber blade assembly for obstructions or damage.
2. Turn the machine ON and open the BERNINA E16 OS.

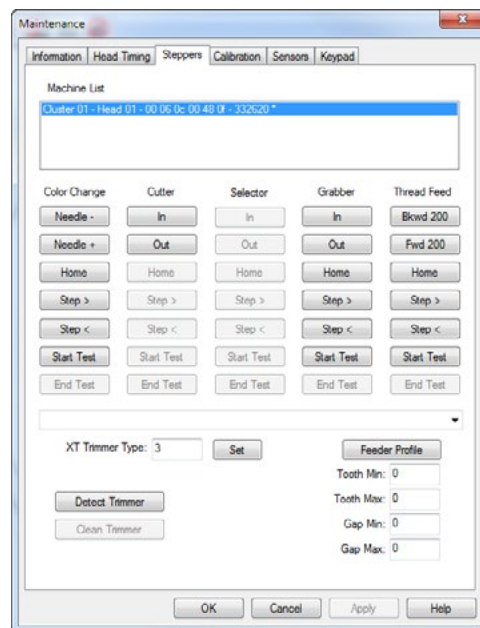

Figure 1 - Steppers Menu

3. Before doing the function test, “step” the motor through its function and check for proper grabber adjustment. The grabber blade should touch the velcro on the upper trap assembly, but it should not depress the loops on the velcro pad. The grabber blade should also be completely parallel to the upper and lower traps. To “step” the grabber stepper motor incrementally through its cycle, click on the “Tools>Maintenance” menu in the BERNINA E16 OS, select the “Steppers” tab and click the “Step>” button in the grabber column, observe the movement and click it again for the next step. Repeat this to observe any obstruction or misadjustment. STOP if you observe any obstruction or adjustment required in the grabber assembly. Use the procedures referring to adjustment prescribed in “Grabber Blade Replacement” to adjust the grabber assembly.
4. If there is a failure in the “stepping procedure” or you find the problem, repair the defect or make the required adjustments and start this test again from the beginning.

BERNINA

5. If no failure is found, or you have restarted the test after finding an earlier failure, then click on the "Start Test" button under the grabber column.

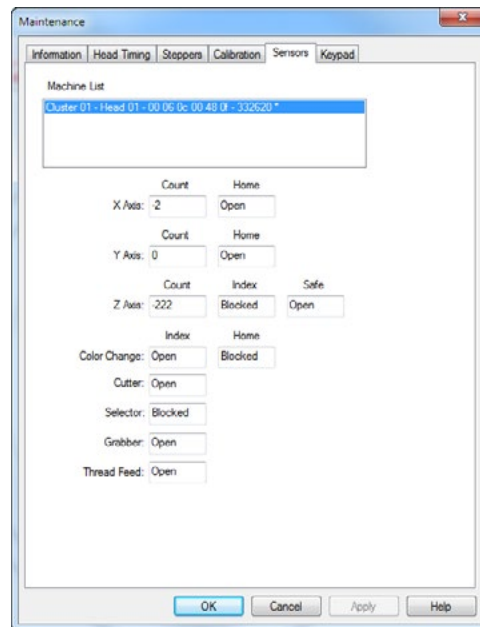

Figure 2 - Sensors Menu

6. Click on the "Sensors" tab and observe the grabber status. It should be alternating between "Open" and "Blocked". In addition, the grabber blade should be extending and retracting between the upper and lower traps without any obstruction or resistance. If all this is happening, everything in the grabber circuitry is good.
7. Return to the "Steppers" menu and click on "End Test" button to stop the test.
8. If you still get grabber related errors at this point, contact Technical Support.

Final Functional Tests

Final functional tests should always be conducted on the Embroidery Peripheral whenever any major repairs or adjustments are made. The purpose of these functional tests is to ensure that the correct repairs and adjustments have been made and that no further machine functional issues remain.

Visual Inspection:

Always inspect the machine after making any repairs and make sure that:

- you have removed all tools and loose hardware;
- all harnesses are correctly connected, routed, and tied;
- all hardware is correctly installed and torqued according to the torque specifications;
- all covers installed prior to any function test, except for specific troubleshooting specified in these instructions.

Functional Tests:

Immediately after any major repairs, it is recommended to run the machine through a set of functional tests. This is best accomplished by running the machine through a full run of the test design AMPASS01A. Visually observe the machine performance through all sixteen needles while the machine is sewing.

You should be observant to the following issues when running the machine Functional Tests:

- X/Y registration issues
- bobbin tension
- thread breaks, pull outs
- unusual noises or behavior

Burn-in:

Immediately after replacing a motor, the Main PCB or the power supply assembly, the machine should be burned in using the test design "AMPASS01A". The machine has to be in the unthreaded mode for this test. The machine should be periodically observed by the customer or machine operator for correct operation during the machine burn-in. The burn-in should last a total of nine consecutive hours.

When a burn-in test is to be conducted at a customer site, it should be done after the test sews are all complete. The burn test should be initiated by the customer or service technician and the customer terminate the burn test after it is completed. It is not necessary that a service technician remain at the customer site while the burn test is run and a return service call after a burn test is not necessary unless problems arise from the burn test. The customer may opt not to do a burn test, but it is strongly recommended that this test be run after replacing any of the motors, the main PCB, or the power supply assembly.

The recommended minimum burn-in after replacing a major component is 3 hours. If the customer is satisfied with the machine operation after three hours in the burn-in test, then the customer may end

BERNINA

the burn test and it is considered a successful test. The burn-in of machines after major repairs ensures quality performance of the machine and helps to identify quality and functional issues. In the long run, using the burn-in test after major repairs will save the customer a significant amount of money in terms of service calls and additional diagnostic work.

To burn in the machine, refer to the following procedures.

Test Sew Outs:

Test sew outs should be conducted after all major repairs, when a machine is reconfigured, and when major adjustments are made to a machine. This includes, but is not limited to:

- replacements of motors, sensors, harnesses or the main PCB;
- replacement or retensioning any of the belts;
- all service calls made by service technicians.

Several small test designs have been created to test for specific functions. This reduces the amount of labor that a customer will be charged for. The main test design (AMPASSxxx) has been broken down into smaller designs that are focused on specific machine functions. AMPASSxxx test design should be run on a machine when a repair has affected all or most of the machine functions. However, if you do something simple, such as adjust or replace the grabber blade or the trimmer stepper motor, it is only necessary to run AMTRIMxxx design (tests for trimmer problems). It is strongly recommended that the appropriate test sew outs be run to validate any repair or major adjustments to the embroidery machine when it affects the functionality of the machine.

For instructions on test sews refer to the Test Designs section.

Optical Sensors Test

Prior to testing optical sensors, clean them using compressed air only. DO NOT use any liquid cleaners or solvents on the sensors. You will permanently damage them if you do.

Testing optical sensors is simply done by using a nonmetallic object and break the signal between the two sensors on the optical sensor PCB (use nonmetallic material in order to avoid shorts if you accidentally touch an electrical component). When you move an object between the two sensors on the optical sensor PCB, the corresponding LED on the Main PCB will illuminate on breaking the signal and turn off when you remove the object from between the two sensors.

If the corresponding LED on the Main PCB fails to illuminate but the Main PCB is functioning properly, then the optical sensor is probably defective, provided continuity in the harness is good on all leads (check only if you replaced the harness). Refer to the replacement section for the respective optical sensor PCB for locations of the corresponding indicator LEDs on the Main PCB.

Power Supply Test

Check the power supply unit itself:

1. Turn the machine off.
2. Disconnect the A/C wallpower supply harness from the main power input connector. Disconnect the external Ethernet cable.
3. Remove the power supply assembly from the machine following the procedures for removing the power supply in the section titled "Power Supply Assembly".
4. Set the power supply on a table or work bench with an A/C outlet close by.



Figure 2 - Power Supply Unit Terminal Jumpers

5. Check and make sure that the jumpers are installed as shown in the picture above. If the terminals are missing, either order replacement jumpers, or you can fabricate replacement jumpers with 16 gauge AWG wire and ring connectors available from any electrical supply store. Replace any missing jumpers
6. Connect an AC power cord into the power entry module on the power switch bracket located on the back of the power supply assembly.
7. Turn the power switch on.



Figure 3 - Power Supply Indicator LED

8. The green LED located on the top right side of the back of the power supply unit should immediately illuminate.
 - a. If the green LED is not illuminated, measure the A/C input voltage at the location shown in Figure 1 above. You should be getting 110V or 220V AC $\pm 10\%$ depending on the wallpower supply. If you have no or low power input at these two terminals, replace the fuse.

BERNINA

- b. If the fuse is good, but you still have no AC input, verify that the wallpower supply outlet is supplying sufficient power to the machine.
 - c. If correct power is being supplied to the machine, and the fuse is good, but the power input is still too low or none, replace the power supply assembly.
 - d. If the power input is correct, and the green LED does not illuminate, replace the power supply assembly. (This indicates that the power supply unit itself has failed.)
9. Use a voltage meter set to measure DC output and measure the voltage output on the upper terminal block, measuring at the middle terminals as shown in Figure 1.
 - a. The black (common) electrode of the voltage meter goes on the ground (black wire) terminal, and the red (positive or hot) electrode of the voltage meter goes on the positive (red wire) terminal.
 - b. Measure the DC output voltages. The range should be between 34.5 to 38 DC volts. If the voltages are not in this range, then replace the power supply assembly.
 10. If the green LED on the side of the power supply unit is illuminated and the 36V DC output is between 34.5 to 38V DC then the power supply assembly is good. Follow the power supply installation procedures entitled "Power Supply Assembly" to install the Power Supply Assembly into the machine.
 11. If none of the above indicates a failure, the power supply assembly is good and can be installed in the machine using the procedures for installing the power supply assembly in the section titled "Power Supply Assembly".

Servo Motor Resistance Test

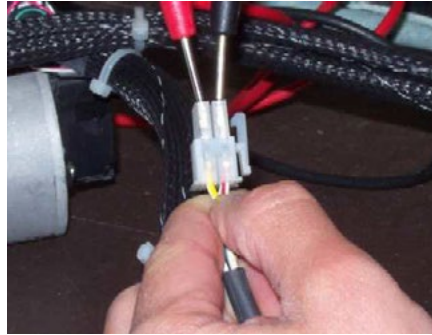

On stepper motors, disregard the green (ground) wires going into the connector and measure the resistance of the servo motor by pushing the leads of the ohmmeter into the connector until they contact the pins as shown in the image above.

i **IMPORTANT:** Set the multimeter to the ohm scale and zero it out by touching the two leads together and pushing the reset button. If the meter you are using does not have a reset button, take note of the resistance measured when the two leads are touched together and subtract that from the actual measurement to get the true resistance measurement.

If the resistance is zero ohms or close to it, it indicates the motor has a short. If the measurement is high, it indicates a break in the circuitry of the motor. Measure the resistance between each of the phase (non-green) wires.

Servo Motor	Resistance Specification
X-Motor	3.4Ω
Y-Motor	3Ω
New Z-Motor	0.6Ω

Stepper Motor Resistance Test

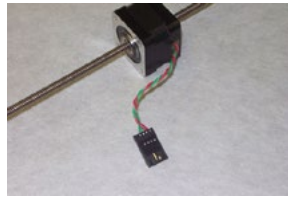

Figure 1

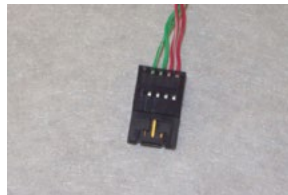

Figure 2



Figure 3

Resistance in the stepper motors is measured on the two phases. To measure the resistance, disconnect the motor at the connectors (see Figure 1). There are four wires to each motor. Starting from either side, the first two wires are one phase and the remaining two wires are the second phase. At the connector, you can see tabs where the pins are (see Figure 2 and Figure 3). These can be used to measure the resistance. Each motor, regardless of the connector, can be measured this way.

i **IMPORTANT:** Set the multimeter to the ohm scale and zero it out by touching the two leads together and pressing the appropriate button to zero your meter (see your meter instruction manual on how to do this). If you do not know how to zero your meter, take note of the resistance measured when the two leads are touched together and subtract that from the actual measurement. This gives you the true resistance measurement.

Measure the resistance of the windings. The readings should be about 10-14% of the following values:

Color Change Motor	7.3 ohms
Grabber Motor	25 ohms
Thread Feed Motor	25 ohms
Trimmer Motor	25 ohms

A low measurement indicates the motor has a shorted winding. A high measurement indicates the motor has an open winding. In either case, the motor should be replaced.

Servo Motor Resistance Test

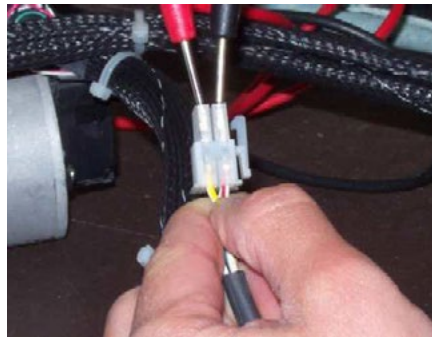

Figure 1 - Resistance Measurement of Servo Motors

Servo Mtr	Resistance Specification
X	$3.65 \pm 10\% \Omega$
Y	$2.28 \pm 10\% \Omega$
Z	$1.04 \pm 10\% \Omega$

When measuring the resistance with a ohmmeter or multimeter, it is strongly recommended that it be done with a calibrated meter rated with resistance reading accuracy equal to or better than $\pm 1\%$. Fluke™ multimeters generally meet this accuracy requirement. Make sure you get this specification when you purchase multimeters used to troubleshoot machine errors.

If you use a meter that does not meet this accuracy specification, go on the assumption that if the readings between the phase leads of the motor are consistent (nonzero resistance) that the motor is probably good. The machine should be considered defective if the measurements are substantially lower than the ranges specified in Step 1 shown in the above table. If you have a phase that has close to a zero reading or measurements between phase leads that are not consistent, then the motor is defective.

“Ohming out a motor” or measuring the resistance between each of the phase wires is easily measures by connecting the leads from the meter to the nonground wires (disregard the green wires). The resistance between each of the phase combinations (3 combinations on all three servo motors) should be consistent and within the ranges shown in Step 1 in the table above.

BERNINA

Test Designs



i Note: Reference to the test design dash level will not be specified in this manual. Instead the design name will refer to the latest available revision of the test design indicated by "XXX" at the end of the design name.

The AMPASSXXX is the official factory "go/no go" design that is used to test all machines before they are shipped to customers. The use of this design to help in diagnostics and troubleshooting is recommended because it allows you to test under known design conditions without having digitizing conflicts involved in the trouble shooting.

This design produces more information when sewn on white broad cloth (or any white polyester material) and one layer of backing. The use of a white colored fabric is important so that the thread contrasts against the white and makes defects in the sew patterns more visible. Avoid the use of white or similar colored threads, as they will blend in to the bobbin thread making it difficult to detect problems.

This design has been broken down into individual components that are available as a separate design as indicated: (click on the separate design name to view the design or to get specifications)

BERNINA

Design Feature	Function Tested
Horizontal and Vertical columns	Thread Tension (upper and lower)
Circles	Belt Tension
Rose	Thread breaks on long stitches
Diamond	Registration
Horse & Buggy	Orientation
Spiral	Thread breaks
Alphabet	Small letter problems
Triangle Fill and Outline	Looping
Tricolored Diamond Fill	Thread Break Sensor
Mark Trim	Trimmer/Grabber
Knit Material	Embroidery on Knit Material

It is important that the appropriate tests are run on the machine after all major repairs or adjustments. These tests validate repairs and adjustments made to the machine and help to identify whether repairs and adjustments were successful.

Thread Tension Test



The thread tension test tests for upper and bobbin tension. When you look at the back side of the sewn material, approximately 1/3 of the width of the bars should show bobbin thread. This however, is subject to a variety of conditions, such as the type of thread being used, material thickness and weight, and quality of thread and material.

The thread tension test should be sewn with not more than one thread break for the entire design. It should be sewn on one layer of white broad cloth (or any white polyester material) or the equivalent with one layer of backing.

Belt Tension Test



BERNINA

The belt tension test design is useful for verifying the adjustments of the x-cable or the y-axis timing belts. When the tensions on both are set to ideal conditions, the thickness of the circles should be consistent in all directions.

The belt tension test should be sewn with not more than one thread break for the entire design. It should be sewn on one layer of white broad cloth (or any white polyester material) or equivalent with one layer of backing.

Long Stitch Test



The long stitch test design is used to test the reliability of the adjustments on the machine for long stitches. This design is recommended to be sewn prior to running any design with a significant number of long stitches or to verify adjustments after repairs made due to failures on long stitch patterns. The design should be sewn with no thread breaks, long tails, or pull outs.

The long stitch test should be sewn on one layer of white broad cloth or equivalent with one layer of 2 oz. cut-away backing.

Looping Test

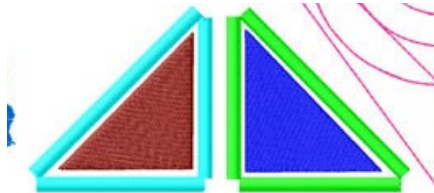

The looping test design is used to test the reliability of the machine on fills and column stitching. There should be no looping in the fills, thread breaks, pull-outs, or any irregularity in the triangles when viewed at arms length with an unaided eye.

The looping test should be sewn on one layer of white broad cloth (or any white polyester material) or the equivalent with one layer of backing.

BERNINA

Orientation Test

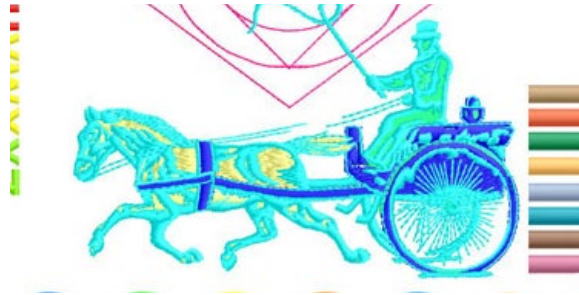

The orientation test design should be sewn twice. Once as shown above, and once again by changing the direction of the orientation. A comparison of the two should be consistent with each other with no changes in appearance or stitch length. In addition, there should be no thread breaks or pull-outs in this design.

The orientation test should be sewn on one layer of white broad cloth or equivalent with one layer of 2 oz. cut-away backing.

Registration Test



The registration test design is used to verify the repeatability of stitches and to ensure that the adjustments to the x- and y-axis is correct. There should be no missed stitches, and the repeatability should be within one stitch point ($\approx 0.1\text{mm}$). This should all be done with no thread breaks or pull-outs.

The registration test should be sewn on one layer of white broad cloth or equivalent with one layer of 2 oz. cut-away backing.

Small Alphabet Test



The small alphabet test design checks for the ability to do small lettering without thread breaks, pull-outs, or other errors. It is useful to check the adjustment of the prior to doing a job that requires a significant amount of small lettering.

The small alphabet test should be sewn on one layer of white broad cloth or equivalent with one layer of 2 oz. cut-away backing.

Thread Break Sensor Test



The thread break sensor test design is helpful to check the thread break sensor to make sure it is sensing thread moving on the thread break sensor bar. The machine reports thread breaks if the thread break sensors attached to the bar do not detect thread running against it when it should be. If there is a valid thread break, the BERNINA E16 OS should report a thread break (no thread running against the sensor bar). Conversely, if there are no thread breaks, there should be no thread break reports. Cut the thread where it runs into the needle a few times to see if valid thread breaks are detected properly. There should be no thread breaks or pull outs other than those that you initiated deliberately for testing purposes. Also, there should be no inconsistency in the fill portion of the design.

The thread break test should be sewn on one layer of white broad cloth or equivalent with one layer of 2 oz. cut-away backing.

Thread Break Test



The thread break test design is helpful to check for thread breaks by running several different stitch lengths and types in several directions. There should be no thread breaks, pull-outs, or long tails when sewing this design.

The thread break test should be sewn on one layer of white broad cloth or equivalent with one layer of 2 oz. cut-away backing.

Trimmer Test

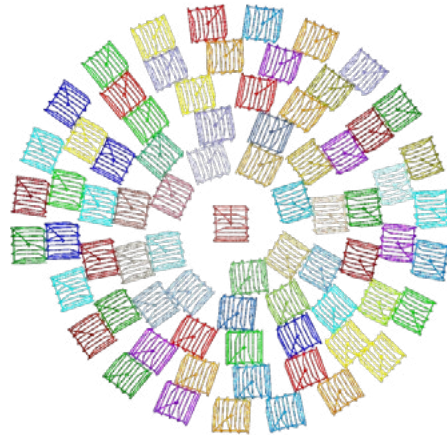

The primary purpose of the AMTRIM01A test design is to test the trimmer and grabber functions. The goal in using this design to verify trimmer adjustments is to reduce trimmer errors down to the absolute minimum possible. If you have more than one trimmer related error for the entire design, you should adjust the trimmer assembly accordingly and then re-sew the AMTRIM01A on a different location of the fabric.

It is further recommended that you make any necessary adjustments to eliminate thread break problems while this design is running. It is recommended that this design is run while you observe it so you see the machine behavior at the time machine errors occur in this design. However, the primary focus of this design is to detect and eliminate trimmer and grabber related errors.

The trimmer test should be sewn with not more than one problem for the entire design. It should be sewn on one layer of white broad cloth or equivalent with one layer of 2 oz. cut-away backing.

Electrical Failures

Color Change Failures

The machine color change is controlled through the use of an encoder, a stepper motor, the controller chip on the Main PCB and the software. The BERNINA E16 OS will usually give an indication of what the actual failure is. The encoder and the color send a signal through the harness to the Main PCB and the status is reported by the firmware to the BERNINA E16 OS, and then displayed on the computer screen.

Step	Procedure	Condition	Solution/Step
1	Check for an obstruction blocking movement of the needlecase assembly	Obstruction found	Clear it
		No problems	Go to Step 2
2	Check for binding on the color change spindle	Bind found	Lubricate the color change spindle
		No bind found	Go to Step 3
3	Turn the machine off and turn it back on again. Reboot the computer and reload the BERNINA E16 OS.	Color change works	Probably corruption of data in the RAM
		Color change fails	Go to Step 4
4	Conduct an optical sensor test on both the needlecase sensor (installed in the needlecase) and the color change home sensor (installed in the lower arm between the reciprocator and presser foot shafts).	Either sensor bad	Replace optical switch assembly
		Both sensors good	Go to Step 5
5	Measure the resistance of the stepper motor (Measure the resistance between the phase wires. Disregard the ground (green) wires.)	Resistance < than 7 ohms	Short in the stepper motor, replace it.
		Resistance > 10 ohms	Open in the stepper motor, replace it.
		Resistance between 7 and 10 ohms	Go to Step 6
6	Above steps failed to find problem.		Contact Technical Support for assistance.

BERNINA

LED Cluster Assembly Failures

Condition	Solution
Both LED Cluster Assemblies do not illuminate with the rest of machine having power.	Troubleshoot the wiring connecting the Main PCB to the LED Cluster assemblies.
One LED Cluster assembly is completely illuminated but the other one is not.	Verify the harness connection first. Then replace the non-functional LED cluster assembly.
Individual LEDs on either LED Cluster Assembly are burned out or fail to illuminate.	Replace the LED Cluster assembly affected.

Mechanical Failures

False Thread Breaks

False thread breaks on the machine are usually caused when the upper tension is too loose, such that the thread sensor fails to detect the thread moving against the thread sensor bar.

Step	Symptom/Procedure	Condition	Solution/Step
1	Check upper thread tension	Too loose	Adjust thread feed parameters in the software
		Correct Tension	Go to Step 2
2	Tighten the thread feed parameters (reduce the amount of thread feed in and see if problem goes away)	Problem goes away	Tension was too loose
		Problem still occurs	Go to Step 3
3	Inspect condition of thread feeder rollers. They may be damaged or worn.	Damaged or worn	Replace rollers
		Rollers all good	Go to Step 4
4	Replace thread break sensor assembly	Problem goes away	Sensor is bad
		Problem still occurs	Contact Technical Support

Loose/Looping Stitches

Possible Causes	Solutions
Thread feed settings too low	Troubleshoot the thread feeder assembly. Check the adjustment of the thread feed parameters in the BERNINA E16 OS software. Contact Technical Support if necessary.
Bobbin tension too low	Adjust the bobbin tension by tightening the screw on the bobbin case. Refer to the Operator Manual for instructions.
Uneven thread size	Replace with quality thread
Rotary hook timing is incorrect	Adjust hook timing
Inadequate rotary hook lubrication	Lubricate the rotary hook
Thread feeder roller worn or damaged	Replace thread feeder roller
Design density too tight	Decrease density (refer to BERNINA E16 OS manual for design editing)

Needle Breaks

Possible Causes	Solution
Needle is bent	Replace needle

BERNINA

Possible Causes	Solution
Needle installation is incorrect	Install needle correctly (see operator manual)
Needle strikes the rotary hook	Adjust hook timing
Poor needle quality	Replace needle
Dull needle tip	Replace needle
Needle too small for fabric	Replace with compatible needle
When sewing caps, using flat needle plate instead of raised needle plate	Install raised needle plate
Needle strikes the needle plate	Check needle case calibration

Skipped Stitches

Problem	Possible Causes	Solutions
Needles	Needle is bent or damaged	Replace needle.
	Incorrect needle for the thread size being used	Replace with a compatible needle
	Needle is installed incorrectly	Install needle correctly (see operator manual)
Needle Depth	Needle bar lowest dead point is incorrect	Adjust needle depth
Rotary Hook	Hook timing is incorrect	Adjust hook timing
	Hook point is dull	Replace hook
Upper/Bobbin Tension	Bobbin thread does not feed out smoothly	Replace the bobbin and/or bobbin case
	Upper thread does not feed out smoothly	Check the condition of the thread feeder roller. If it is bad, replace it. Adjust the thread feed parameters in the BERNINA E16 OS software. If that does not solve the problem, replace the optical sensor switch assembly.
Presser Foot	A weak or broken presser foot prevents the needle from coming out of the fabric smoothly	Replace the presser foot spring
Thread	Thread twist is too tight	Use the appropriate thread or consult Technical Support for suggestions
	Thread is too elastic to form an adequate loop	Use the appropriate thread or consult Technical Support for suggestions

BERNINA

Thread Breaks

Possible Problem Area	Solution Checklist
Material thickness setting may be incorrect	<ol style="list-style-type: none">1. Check the material thickness and adjust if set too high or too low. If material thickness is set too high, too much thread is being fed into the system, and you may see some of these symptoms: looping, popping thread breaks, and no bobbin showing on the back of the fabric. If material thickness is set too low, not enough thread is being fed into the system, and you may see some of the following symptoms: pulling, puckering, fraying thread, thread breaks, and bobbin showing on the top of the fabric.
Stitches may be too short and/or too dense	<ol style="list-style-type: none">1. Check the design for short and/or dense stitches, and edit the design to remove them. One effective method of removing dense stitches is to run the Stitch Proximity Filter. One way to remove short stitches is to open Design Filter (Tools->Design Filter). Adjusting the setting of After 1 Short to After 0 Short will filter ALL stitches of 4 points (the default Short Stitch Length) or less from the design.
Bobbin Tension, Bobbin Thread, Bobbin Case	<ol style="list-style-type: none">1. Check bobbin tension as specified in this manual.2. Make sure that the bobbin has been placed correctly in the bobbin case.3. Inspect the bobbin case and make sure it is not damaged and that it is clean.

BERNINA

Possible Problem Area	Solution Checklist
Needles / Needle Depth / Needle Plate	<ol style="list-style-type: none"> 1. Check needle orientation. If a needle is installed backwards or turned too much, thread breaks can occur. It is recommended that the eye of the needle be tilted 5° to the right; however a range of needle orientation is acceptable. The eye of the needle can be facing directly forward or be tilted to the right by a maximum of 20°. 2. Inspect needle(s) for damage such as burrs, scratches, and dullness. Replace if necessary. 3. Make sure you are using the correct needle(s) for the size of thread being used. 4. Check needle depth to make sure that it is correct. 5. Verify that the needles are centered in the needle plate. The needle needs to pass approximately through the absolute center of the hole in the needle plate without rubbing or hitting the needle plate. If this isn't the case for the majority of the needles (i.e. most needles are far off to the right or left). 6. Inspect the needle plate hole to be sure it's free of nicks, burrs or anything that may cause the thread to fray. Replace if necessary.
Thread / thread path	<ol style="list-style-type: none"> 1. Make sure the machine is threaded properly (see Upper Threading for instructions). Make sure that there is no misguided thread. The thread should be centered in the groove under the thread feed rollers. Make sure that no thread is caught or wound around the thread feeder gears. Make sure the red pinch rollers are down. 2. Make sure you are using high quality thread. Look for kinks, frays, or thread which seems to unravel and/or twist during use. If the thread is suspected to be bad, exchange with a high quality thread to try and isolate the problem. 3. Be sure the thread tubes, which pass along the center of each thread cone, extend at least 1" beyond the end of the cone. Otherwise, the thread may become tangled. 4. Be sure the thread cones are fully seated against the thread tree base. If not, the thread could become entangled beneath the cone.
Thread feeder / Pinch rollers	<ol style="list-style-type: none"> 1. Inspect thread feed & pinch rollers for wear and/or damage. Replace if necessary.

BERNINA

Possible Problem Area	Solution Checklist
Fabric and hoops	<ol style="list-style-type: none"><li data-bbox="532 243 1463 447">1. Check how the garment is hooped; garment may be hooped too loosely. <p>If you can easily pull thread without lifting the pinch roller, the thread feeder roller may be worn / damaged and should be closely inspected.</p><p>The fabric should be very taut in the hoop, similar to a drum. Depending on the fabric, if it is slipping in the hoop, you may need to wrap the bottom hoop with a fabric "seam binding."</p><li data-bbox="532 600 1507 722">2. Make sure the hoop arms are attached securely. <p>It is important that the arms are securely attached to the machine. If you can wiggle the hoop arms side to side, they are too loose.</p><li data-bbox="532 743 1511 1115">3. Make sure hoop arm bracket clips are secured tightly. <p>When you slide the hoop underneath the bracket clips, both sides should snap securely into place. If either side of the hoop can move front to back or is not seated underneath the clip, the hoop may move during sewing. Click here for instructions on tightening.</p><p>A quick test to see if the arms and/or clips are loose is to sew a fill pattern inside a border. You will likely notice poor registration. The concentric circles in the test design are good for this as well. You will notice more distortion in the X direction than in the Y direction.</p><li data-bbox="532 1136 1490 1297">4. Check the backing you are using. <p>Inadequate backing allows fabric to be pulled into the needle plate hole. If needed, increase the number of backing pieces or change backing type.</p><li data-bbox="532 1318 1507 1522">5. Review the weight of the garment being sewed. <p>If you are sewing a particularly heavy garment, try sewing at a slower speed to see if the thread breaks become less frequent. Furthermore, if there is an abundance of material hanging outside the hoop, be sure it hasn't become tangled with adjacent hardware.</p><li data-bbox="532 1543 1516 1814">6. Make sure the hoop isn't hitting the needle plate. <p>On occasion, due to frequent use and possibly rough operation, it may be that the hoop arms and/or the hoop itself become bent downwards. As a result, if sewing very close to the hoop perimeter, the hoop may hit against the needle plate causing a thread break. Examine the hoop arms; if they are bent down, they most likely need replaced. Contact technical support.</p>

BERNINA

Possible Problem Area	Solution Checklist
Rotary hook	<ol style="list-style-type: none"> 1. Check the hook timing and the needle gap; one (or both) may be out of adjustment. 2. Check to make sure the rotary hook is rotating smoothly & sufficiently oiled. <p>If it is not, clean, oil, and if the problems persist, replace.</p>

If you are still experiencing thread breaks after checking all of the areas discussed in the above table, you may want to perform a more in-depth analysis. This analysis involves sewing out the test design.

From the beginning of the test, if the problems are addressed as described below, their frequency should become much less as you continue the test. (Note: the most challenging is the small lettering; quite often, resolving thread breaks in this area will solve any thread break problems.) As you sew the test design, use the following table to troubleshoot problem areas.

If thread breaks occur when sewing:	Check the following items:
Horizontal or vertical bars at startup, or soon after (also called miss-starts).	<ul style="list-style-type: none"> • Hook timing and needle guard gap • Make sure tail length (length of thread tail left after a trim) is adequate • Make sure that thread is being held in trap (in grabber assembly) during trims • Check the under thread presser spring • Inspect thread feeder rollers & pinch rollers for wear and/or damage
At the startup of the small lettering	<ul style="list-style-type: none"> • Hook timing
Small lettering (after startup)	<ul style="list-style-type: none"> • Needle depth • Hook timing and needle gap • Needle orientation • Make sure the needle plate is centered • Inspect thread feeder rollers & pinch rollers for wear and/or damage
Triangles & Fill	<ul style="list-style-type: none"> • Hook timing. Hook timing is the most frequent cause of thread breaks in this area • Inspect thread feeder rollers & pinch rollers for wear and/or damage
At the startup of the circles	<ul style="list-style-type: none"> • Needle gap

BERNINA

If thread breaks occur when sewing:	Check the following items:
Circles (after startup)	<ul style="list-style-type: none"> • Burrs on needle plate hole • Needle orientation • Hoop may be hitting needle plate • Inspect thread feeder rollers & pinch rollers for wear and/or damage
Diamond	<ul style="list-style-type: none"> • Needle orientation • Needle gap • Inspect thread feeder rollers & pinch rollers for wear and/or damage
Horse and Buggy	<ul style="list-style-type: none"> • Needle orientation • Inspect thread feeder rollers & pinch rollers for wear and/or damage
Spiral and Starburst	<ul style="list-style-type: none"> • Needle orientation

Miss-Starts

Possible Causes	Solutions
Tail length (length of thread tail left after a trim) may be set too short	In the software, select the Tools>Settings, then click the Machine tab. Change the tail length setting to Medium or Long.
Thread is not held in grabber trap during trims	Grabber blade and/or grabber trap assembly may be to be adjusted or replaced

Cap Frame Issues

Possible Causes	Solutions
Poor overall embroidery quality	Make sure the cap is hooped properly Modify the design Check the driver bar tension Check the spindle adjustment Check that the driver was properly adjusted on the peripheral
Puckering	Modify the design

BERNINA

Possible Causes	Solutions
Loss of registration	Adjust cap supports (if being used) Modify the design Check the driver bar tension Check the spindle adjustment Check that the driver was properly adjusted on the peripheral
Cap frame is loose on the driver	Check the spindle adjustment

Miscellaneous Problems

Problem	Solutions
Birdnesting	Thread may be wrapped around the rotary hook; check hook timing

BERNINA

X-Axis Failures

The x-axis motion on the machine is controlled through the electronics, a system of pulleys and a cable. The motor driver on the Main PCB will send certain commands to the X-axis servo motor. Feedback to the Main PCB is provided by the motor encoder and the X-home sensor. These devices tell the Main PCB where the motor is at during embroidering.

Problem	Possible Causes	Solution
Binding in x-axis or jumpy, uneven movement of the x-carriage	Improper Adjustment of x-carriage linear bearings	Adjust the radial bearings on the x-carriage assembly
	Lack of lubrication on the carriage rails in the x-beam	Lubricate the carriage rails
	Fretting corrosion of the x-rails	Replace the x-beam and the bearings on the carriage
	X-cable tension too high	Adjust x-cable tension
	Damaged x-cable	Replace the x-cable
	Damaged bearing(s)	Replace the radial bearings on top of the x-carriage
	Damaged pulley	Replace the damaged pulley.
Excess noise when carriage moves	Lack of lubrication to the carriage rails	Lubricate the carriage rails
	Improper adjustment of the x-carriage linear bearings	Adjust the linear bearings
	Cable tension too high	Adjust x-cable tension
	Fretting corrosion of the carriage rails	Replace the x-beam and the bearings on the carriage
X-axis runaway	Connection at motor encoder reversed	Reconnect the interface harness to the x-motor correctly
	Short in either the x/y home harness or the motor interface cable	Replace the defective harness
Can not find home	X/Y Home Not Set message will appear in the software message text box	Set x/y home
	Dirty or damaged sensor	Clean or replace the x-home optical switch assembly.
	Loose harness connection	Reconnect the harness

BERNINA

Y-Axis Failures

The y-axis motion on the machine is controlled by the electronics. The motor driver on the Main PCB sends commands to the motor. Feedback to the Main PCB is provided by the y-motor encoder and the x/y home sensor PCB. These devices tell the software and the Main PCB where the motor is during embroidering.

Problem	Possible Causes	Solution
Binding in y-axis or jumpy, uneven movement of the x-beam	Bad bearings in the idler pulley	Replace the idler pulley assembly
	Y-drive timing belt tension too tight or too loose	Adjust the y-belt tensions
	Fretting corrosion of the y-rails	Replace the y-rails and the bearing block assemblies.
	Lack of lubrication	Lubricate the bearing block assemblies.
	Damaged belts	Replace both y-axis timing belts.
	Binding in the motor windings	Replace the y-motor.
Excess noise when the x-beam moves	Lack of lubrication to the y-axis rails	Lubricate the bearing block assemblies
	Incorrect belt tension	Adjust the y-timing belt tensions.
	Fretting corrosion of the carriage rails	Replace the y-rails
Y-axis runaway	Connection at motor encoder reversed	Reconnect the interface harness to the y-motor correctly
	Short in either the x/y home harness or the motor interface cable	Replace the defective harness
Can not find home	X/Y Home Not Set message will appear in the software message text box	Set x/y home
	Dirty or damaged sensor	Clean or replace the x/y home PCB.
	Loose harness connection	Reconnect the harness

BERNINA

Z-Axis Failures

The z-axis movement on the machine is controlled by the electronics. The motor driver on the Main PCB sends signals to the Z-motor. Feedback to the Main PCB is provided by the encoder and the z-index optical sensor. These devices tell the software and the Main PCB where the z-motor position is at during embroidering.

Problem	Possible Causes	Solution
Binding in z-axis or jumpy, uneven movement	z-shaft out of alignment, bearings lost preload	Contact Technical Support. This will require factory repair if true.
	Z-drive timing belt tension too tight or too loose	Adjust the z-belt tensions
	Damaged z-axis timing belt	Replace the z-axis timing belt.
	Binding in the motor windings	Replace the z-motor.
Excess noise in the needle-bar area	Lack of lubrication to the needle bars	Lubricate the needle bars
	Lack of lubrication to the reciprocator or presser foot	Lubricate the needle drive and presser foot
	Damaged needle bar	Replace damaged needle bar
Z-axis runaway	Connection at motor encoder reversed	Reconnect the interface harness to the z-motor correctly
	Short in either the z motor harness or the motor interface cable	Replace the defective harness
Can not find z-home	Z-axis flag loose	Set Head Up Position
	Dirty or damaged sensor	Clean or replace the z-index PCB.
	Loose harness connection	Reconnect the harness

Software Error Messages

The software generates messages pertaining to the condition of machine components and the electrical current used to power the machine in case changes to the machine status or a machine error occur. These messages make much of the machine a self-diagnostic machine. The messages below represent true error messages that the software might generate. Messages which merely report a change in the machine status are not included in the list below.

If you receive an error message not described below, contact Technical Support for instructions.

Error Message	See Section Below
Can't empty TI-DSP FIFO error	DSP Command Errors
Can't init color, Z not in SAFE ZONE	Can't Initialize Stepper Motors
Can't init grabber, Z not in SAFE ZONE	Can't Initialize Stepper Motors
COLOR CHANGE seek error	Stepper Motor Time Out and Index Errors
COLOR CHANGE timeout error	Stepper Motor Time Out and Index Errors
DOS checksum error	DSP Command Errors
DSP timeout error	DSP Command Errors
Error trying to read stepper motor status	Error trying to read stepper motor status
E-Stop Engaged	E-Stop Engaged
ES segment register error	DSP Command Errors
FEEDER stepper index error	Stepper Motor Time Out and Index Errors
FEEDER timeout error	Stepper Motor Time Out and Index Errors
GOTO func error	Goto Func Error
GRABBER stepper index error	Stepper Motor Time Out and Index Errors
GRABBER timeout error	Stepper Motor Time Out and Index Errors
HOOP CENTER error	Hoop Center Error
Missed headup while sewing	Servo Motor Errors
No trace data	No Trace Data
TI-DSP error	DSP Command Errors
TI-DSP memory test error	DSP Command Errors
TI-FIFO empty	DSP Command Errors
X-Motor HALL Error	Servo Motor Resistance Test
X-Motor Home Timeout	Servo Motor Errors
X-Motor OVER CURRENT error	Servo Motor Errors
X not done	X- or Y- Not Done Error
X timeout error	Servo Motor Errors
X tracking error	Servo Motor Errors
XY home not set	XY Home Not Set
Y-Motor HALL error	Servo Motor Resistance Test

BERNINA

Error Message	See Section Below
Y-Motor Home Timeout	Servo Motor Errors
Y-Motor OVER CURRENT error	Servo Motor Errors
Y not done	X- or Y- Not Done Error
Y timeout error	Servo Motor Errors
Y tracking error	Servo Motor Errors
Z-motor HALL error	Servo Motor Resistance Test
Z-Motor not at HEADUP error	Servo Motor Errors
Z position error	Servo Motor Errors
Z timeout error	Servo Motor Errors
Z tracking error	Servo Motor Errors

DSP Command Errors

A DSP command error occurs when the motor controller (on the main control PCB) receives an invalid command sequence. This results in a fatal error and the CPU halts.

If you experience a DSP command error on the machine, record as much data as you can relating to the status the machine was in when the error occurred (i.e., z-position, design sewn, action before, action after). Also record the stitch number of the design where the error occurred. Technical support will attempt to replicate the error using the same design, so you will likely be asked to send us a copy of the design.

Can't Initialize Stepper Motors

The actual messages generated by the software are:

- Can't init color, Z not in SAFE ZONE
- Can't init grabber, Z not in SAFE ZONE

These errors are generated when the firmware installed on the Main PCB attempts to put the color, cutter, or grabber in the home position to allow Z-axis movement to occur safely. If the stepper motors are not in the "Z safe zone" or their respective home positions, then these errors are generated.

To clear these errors, make sure the stepper motor is in the home position. If the stepper motor is not going to the home position, troubleshoot the stepper motor using the advanced troubleshooting procedure.

No Trace Data

No design is loaded to run the trace function on. Load a design and then execute the trace function.

XY Home Not Set

The x- and y-home positions are not in synchronization. The x- and y-axis home positions must intersect each other. The machine cannot make accurate moves to certain points in a design unless this is done.

Set x- and y-home positions using the procedures prescribed in "X/Y Home Adjustment".

BERNINA

Goto Func Error

This error occurs when you attempt to go to a stitch or color (i.e., color change, move, trace, etc) when the machine is already performing some function.

Wait until the machine has completed the current function, then you can perform the function that you attempted to execute.

Hoop Center Error

This error occurs when you try to center the hoop while a design is sewing, or while you are in the middle of a design. Wait until the design is finished or clear the design and then center the hoop.

Stepper Motor Time Out and Index Errors

Time out errors are generated when the Main PCB does not receive a signal from the stepper motor register that the motor has moved to a specified position within the time allocated by the firmware. When it takes too long for the Main PCB to get a signal from the optical sensor that the stepper motor has moved to a specified position, then a time out error is generated.

Index errors are generated when the Main PCB does not receive a signal from the index sensors that the motor is at the index position to allow some other function of the machine to proceed.

If you are getting this error frequently, troubleshoot the problem using the steps shown in the table below.

Step	Action	Symptom	Next Action
1	Check for a bind or obstruction of the assembly the motor controls.	Obstruction found	Remove the obstruction
		No obstruction	Go to Step 2
2	Verify harness connections	Loose connection	Secure the connectors. If necessary use cable ties.
		No loose connections	Go to Step 3
3	Inspect the harnesses for bare, broken, or pinched wires, chaffing or other damage.	Any found	Replace the grabber/thread feed/cc home harness.
		No damage to wires	Goto Step 4
4	Trouble shoot the stepper motor using the procedures in "Troubleshooting Stepper Motors".	Status box does not alternate between "Open and Blocked"	Replace the optical sensor PCB. The sensor is not detecting home.
		Status box alternates back and forth	Go to Step 5
5	Test the optical sensor using the steps prescribed in "Testing Optical Sensors"	Optical Sensor is dirty	Attempt to clean it or replace it
		Optical Sensor good	contact Technical Support. The Main Control PCB might be defective.

BERNINA

E-Stop Engaged

This message is not necessarily an error, but you might receive other related errors if the E-Stop is showing to be engaged, especially when you attempt to execute a machine function and the E-Stop button is not engaged (released and extending completely forward).

Possible Causes of a False E-Stop Engaged Message

- User Interface Harness not plugged in correctly at keypad or control PCB (most probable)
- faulty circuitry on Main PCB
- defective E-Stop switch (least likely)

Troubleshoot a false E-Stop engaged error following the steps described in the table below.

First, remove the base cover and locate the E-Stop LED located at position D49 on the main PCB. Observe the condition of this LED (on or off) as you perform the following troubleshooting steps (machine must be turned on with the software loaded).

Step	Action	LED Condition	Next Step/Solution
1	Inspect the user interface harness and the harness connections. Make sure the harness connections are secure. Disconnect and reconnect both ends of the harness and make sure they are both securely connected.	OFF	Problem was a loose or improper connection.
		ON	Replace the harness if kinked, chaffed or connectors damaged or worn. Otherwise go to step 2
2	Disconnect the harness from the back of the user interface.	OFF	Replace the user interface assembly
		ON	Go to Step 3
3	Select the "Keypad" tab in the "Tools>Maintenance" menu. Look at the "E-Stop Button. This button and the LED at D49 should be at the same state, ON or OFF.	Same as E-Stop button in keypad test	E-stop switch is defective, replace it
		Different State	Possible fault on the Main PCB. Contact Technical Support.
3	Reconnect the harness to the back of the user interface and disconnect the user interface harness from the main PCB.	OFF	Replace user interface harness
		ON	Go to Step 4

BERNINA

Step	Action	LED Condition	Next Step/Solution
4	Close the software on the computer.	ON	Replace Main PCB
		OFF	Problem is probably software related. Reboot the computer. If the problem persists, reinstall the software. If that does not fix the problem, contact Technical Support.

BERNINA

Servo Motor Errors (Move Time Out, Tracking, and Over Current Errors)

This error occurs when the machine takes too long to find the home or index position when the software is prompted to move. Typically, this is a break in continuity of home sensor circuit.

Troubleshoot motor timeout errors using the following procedures for the affected motor:

Step	Action	Result	Next Step/Solution
1	Look for an obstruction to the respective axis served by the motor. Obstructions can include, but are not limited too: fabric stuck in the machine, corrosion to the shafts, lack of lubrication, damaged bearings. You might have to replace both the shafts and bearings if lack of lubrication is the cause.	Dry shafts or rails but no corrosion	Lubricate the shafts
		Dry shafts or rails, corrosion present	Replace the shafts
		Damaged Bearing	Replace the bearing
		Obstruction found	Remove obstruction
		No damage or corrosion	Go to Step 2
2	Check the belt tensions and condition of the belts for the respective motor servicing the axis.	Tensions loose or tight	Retension belt
	For x-axis errors, also check the adjustment on the carriage bearings.	Tensions in specification	Go to Step 3
3	Inspect the main PCB for obvious damage around the area where the motor harness connects to, especially the frets. Look for burned items.	Visible electrical burn or other obvious PCB damage	Replace the main PCB
		No obvious damage	Go to Step 4
4	Look for loose optical sensors, harness connections, or obvious damage to the harnesses	Damaged	Replace it
		Loose	Tighten screw or connector
		No loose connection or damage	Go to Step 5
5	Conduct an optical sensor test to verify that the optical sensors servicing the affected circuit are working	Sensors defective	Replace the sensors
		Sensors good	Go to Step 6
6	Reboot the software and turn the machine off and then back on.	Problem does not recur	Probably data corruption in the firmware or software
		Problem recurs	Go to Step 7

BERNINA

Step	Action	Result	Next Step/Solution
7	Conduct a Servo Motor Resistance Test to check the resistance of the windings on the motor servicing the circuit with the error	Ohms measure near zero or inconsistent with other phases.	Replace the motor
		Resistance is within specifications	Go to Step 8
8	Problem is caused by something in the circuitry of the main controller PCB	You will probably need to replace the main controller PCB	Contact Technical Support and discuss the problem with them.

BERNINA

Critical Measurements

Contents & Critical Mechanical Settings and Assemblies	
Introduction	
Set the angle of your PCB before you set the Z-timing. Z-TIMING: Bottom Center and Head Timing	179.5-180.5 Z-degrees - Bottom Dead Center Hook Timing: 201.5° ± 0.5° .001" [0.028mm] Z-Axis Rise: 182 ° - 183 °
Needle Depths	1/2 of through portion of needle eye
Hook Timing	201.5° ± 0.5°
Needle Drive Stud to Reciprocator Fit	0.006" [0.15mm] max.
Upper Arm to Lower Bed Alignment	True position:.010" (±0.004")
Needle Case Calibration	True position:.010" (±0.004")
Needle to Hook Gap	0.004- 0.012" [0.1- 0.3 mm] (reference)
Hook to Retaining Finger Gap	0.018" -.022" [0.46 mm - 0.56 mm] minimum
Take-up Lever Stroke	56-58 mm
Take-Up Lever Fit to Shaft	Free Rotation
Take-Up Lever End Play	0.030-0.040" [0.75-1.15mm]
Cam Follower Preload	4.5-5.0 in-lbs.
Pull Force on Take-Up Lever	1.4-1.5 lbs
Color Change Lead Screw	0.025" [0.64mm] straightness
Color Change Housing Location	
Bobbin Tension	22 to 25grms/force
Presser Foot Adjustment @ BDC	0.1- 0.6 mm
Thread Feed FWD 200	88-90 mm
Needles	DBxK5 75/11
Needle Orientation	5° to the right recommended range of 0°-20° to the right is acceptable
Z-Belt Tension	68-72 Hz [6.8±0.3 lbs.]
X-Cable Tension	145 ± 5 Hz [10.5 ± 0.5 lbs.]
Y-Axis Timing Belt Tension	45-50 Hz [8.1 ± 0.3 lbs.]
Maximum Front to Back Needle Position Variance	.006" [0.15mm]
Proper Lubrication of Moving Parts	

Introduction

The critical measurements in these instructions were extracted from Engineering documents that establish the official criteria for adjustments and settings on the embroidery machine. Deviation from these standards is not authorized unless a deviation order signed by the manufacturer is received. Failure to

BERNINA

correctly adjust the settings described in this manual can result in unpredictable behavior of the machine and can cause premature failure of the machine.

In most cases, it is necessary to use the prescribed procedure to measure the settings and adjustments on the machine. Deviation from established procedure or using different methods to do the measurements will often yield different results. In order to obtain consistent measurements, use the procedures described in these instructions.

Use the correct tools and instructions for measurements and adjustments on the machine. The machine is sensitive to incorrect adjustments and is easily damaged when the settings on the machine is not correctly set.

These instructions are targeted to trained authorized technicians. The assumption is made that the field technician has received full training in the use of the tools described in these instructions. Therefore, no attempt is made to explain how to use the tools indicated or how to install them on the machine. These instructions also assume that the technician performing these procedures is fully knowledgeable with the machine parts and their orientations.

Needle Drive Stud to Reciprocator Fit

Measurement

1. Needle drive stud to reciprocator fit is measured in terms of the amount of vertical free play in the needle with the machine powered up.
2. Color change to either needle 1 or 16. Measure the vertical free play of the current needle using a dial indicator fixture (Fixture Number 32453) to measure the distance that the needle bar travels up and down. It should be less than 0.006" [0.15mm].
3. Color change to the next needle and measure it, and check all 16 needles.

Adjustment

There is no adjustment to the needle drive stud to reciprocator fit.

If the fit is found outside of the 0.006" [0.15mm] maximum specification, report this via email to the machine manufacturer.

Hook Timing

See hook timing section in this manual.

Upper Arm to Lower Bed Alignment

Measurement

1. Measurement of the upper arm to lower bed alignment is done by measuring the average of the needle centering front to back, starting with the "closest needle."

BERNINA

2. Color change to the closest needle (annotated in the base casting, right front corner). Move the needle to bottom dead center and center the needle plate on the needle. If you are not able to bring the needle down into the needle plate hole, the head is out of alignment and the machine will require shipment to the factory for depot repair.
3. Compare the centering of Needles 1 and 16 in the needle plate hole. If the difference between the two is greater than ± 0.004 " [0.1mm], the head is out of alignment. There is no way to measure head alignment. If a visual comparison of the needle centering of Needles 1 and 16 are substantially different, the head is out of alignment and requires realignment. This is best done at the factory and Technical Support should be contacted if this situation is discovered.

Head Alignment Procedure

Head alignment is best performed at the factory with specialized tools and fixtures. Please contact your technical support provider for specific instructions.

Needle to Hook Gap

Hook gap repeatability refers to the hook gap on all of the needles compared to the "closest needle."

Measurement

See needle to hook gap section in this manual.

Hook to Rotary Support Gap

See hook to rotary support gap section in this manual

Take-Up Lever Stroke

The take up lever stroke is the amount of vertical distance that the take-up lever travels from bottom dead center to top dead center. This distance should be between 56-58 millimeters.

Measurement of Take-Up Lever Stroke

 *Note: Measurement of the take-up lever stroke must be done with the grabber blade mounted.*

1. Hang a weight (approximately 10-12 grams) to the take up lever so that it hangs adjacent to the scale on the ruler pressed to the bottom side of the middle thread guide.
2. Press the E-stop button (in case the machine is powered up), rotate the z-shaft manually through a complete cycle using the bottom of the 10-12 gram weight as the

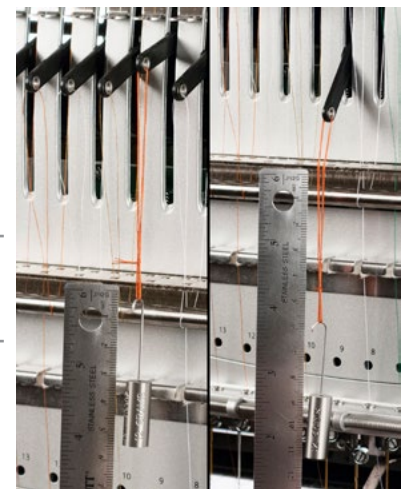

BERNINA

measuring point and take note of the measurement at the top dead center (TDC) and the bottom dead center (BDC) of the take-up lever stroke. Take the measurements several times to ensure a consistent measurement. The difference between the TDC and BDC measurements of the take-up lever, is the take-up lever stroke measurement. This measurement should be between 56mm and 58mm.

Adjustment

Currently, no process to adjust the take-up lever stroke has been defined.

If the take-up lever stroke exceeds the 56-58mm specification, contact your technical support provider.

Take-Up Lever Fit to Shaft

When the take-up levers are assembled onto the take-up lever shaft, they should rotate easily on the shaft with no binding. To check this, rotate the take-up lever on the shaft with your fingers.

If the take-up levers bind or there is significant resistance in the rotation, replace the take-up levers.

Take-Up Lever Endplay

Measurement

Take-up lever endplay refers to the left or right play of the take-up levers on the take-up lever shaft.

Measure the endplay by sliding the take-up levers all the way to the right and measure the distance between the right edge of the last take-up lever to the retaining clip. This distance cannot exceed the range of 0.030-0.040" [0.75-1mm].

Adjustment

Adjustment of the take-up lever endplay is done by loosening the screws that clamp the take-up lever shaft in the mounting blocks and gently tapping the take-up lever shaft in the direction needed to adjust it.

If you loosen the screws on the take-up lever mounting blocks, ensure they are re-torqued to the torque specifications.

Cam Follower Preload

Measurement

Cam follower preload is the amount of spring force that is applied against the cam follower.

Use a pull force gauge and measure the amount of force necessary to move the cam follower from the take-up lever cam.

BERNINA

Adjustment

Current procedures require the use of a fixture to adjust the cam follower preload. This requires that the color change housing assembly be removed and shipped to the factory for repair.

If the cam follower preload is out of specification, contact Technical Support for instructions.

Pull Force on Take-Up Lever

Measurement

1. Ensure that the take-up lever of the current needle is at full "head-up" position.



Figure 1: Measurement of Take-Up Lever Pull Force

2. Using a force gauge (PN: 995591-01), measure the amount of pull force it takes to lift the take up lever up to a point just before it hits a hard stop. Do not allow the take-up lever to hit the hard stop or the measurement will be inaccurate.

Adjustment

If the measurement is not between 1.4 to 1.5 lbs, readjust the preload on the take-up lever spring.

Color Change Lead Screw

Measurement

1. The straightness of the color change lead screw cannot exceed 0.010" [0.25mm] at any point of the threaded section.
2. Measure the straightness by placing a straight edge against the color change screw and measuring the gaps between the straight edge and the screw.

Adjustment

If the straightness of the color change feed screw exceeds 0.010" [0.25mm] it must be replaced following procedures shown in this manual.

Color Change Housing Location

Measurement

1. The measurement of the color change housing location is done in reference to the top inside edge of the upper v-rail.
2. The squareness of the location is the difference between the perpendicular measurement of the distance from the left front and right front edges of the color change housing base to the inside edge of the v-rail.
3. The location of the color change housing assembly should be no more than 0.010" [0.25mm] out of square (difference between the left- and right-side measurements).

Adjustment

1. To adjust the location of the color change housing assembly, loosen the screws on the base of the assembly just enough so that you can move the assembly.
2. Position the assembly to obtain the required squareness and then re-measure the color change housing location. After adjusting the squareness of the color change housing it needs to be checked that the take-up lever drive gear still clears all 16 take-up levers. Should this not be the case the drive gear needs to be readjusted.
3. When the location is square to less than 0.010" [0.25mm], tighten the mounting screws to torque specifications.

Bobbin Tension

Measurement

Using a Gauge pull the thread slowly until the bobbin starts feeding this should happen between 22 to 25grms/force or 220 to 250mN. This is tighter than the tension typically set for bobbins on other embroidery machines.

The following procedures below approximates this tension specification for technicians who do not have thread tension measurement devices in the field and should be used to check bobbin tension on the machine.

Checking Bobbin Tension

To check the tension of the bobbin, hold the bobbin thread with one hand. As you gently release the bobbin case, it should not drop. With the bobbin case hanging on the bobbin thread, bounce the case slightly and it should drop about ¼-½ inch.

Adjustment

If the tension is too tight or too loose, use a flat-blade screwdriver to turn the screw clockwise to tighten or counterclockwise to loosen the tension. A little bit goes a long way; adjust as necessary.

The machine functions better when the bobbin is full. When the bobbin spools reaches the last 1/16" or so of thread the tension loosens drastically and false bobbin and other errors result. If this happens, replace the bobbin thread with a new spool and recheck the bobbin tension.

Presser Foot Adjustment at Bottom Dead Center

Measurement

Measure the presser foot adjustment at bottom dead center (BDC) without a hoop installed. This is the distance from the bottom of the presser foot to the top portion of the needle plate dome. Use a feeler gauge to measure this adjustment.

The height of the presser foot from the top portion of the needle plate dome should be 0.1-0.6 mm when the needle is at BDC.

Adjustment

For minor adjustments to the presser foot height, use the presser foot eccentric located behind the lower section of the needlecase to adjust it.

For adjustments to the presser foot eccentric itself, contact Technical Support for instructions.

Thread Feed Forward 200

Thread Feed Forward Measurement

1. In the Tools>Maintenance>Steppers menu of the the software, click the Fwd 200 button.

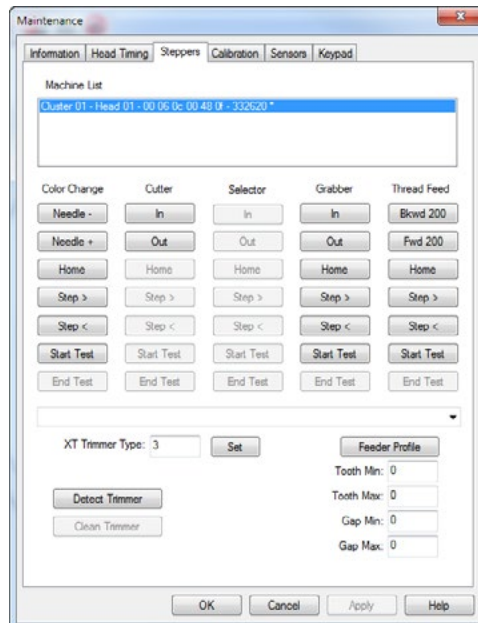

2. Trim the thread that is fed out at a common, repeatable reference point, such as the front edge of the grabber blade.
3. Click the Fwd 200 button again and trim the thread again at the exact same point as you did in step 2 above.
4. Measure the length in millimeters (mm) of the thread you snipped off. This length should be between 88-90 mm.

Needles

 *The quality and type of needles used can greatly affect the operation of the machine, and needles which have burrs, worn tips, or that are bent should not be used.*

Needle Orientation

Embroidery needles have a front and a backside. The needle must be installed correctly or the sewing quality will suffer. The front of the needle has a long groove, while the back has an indented scarf. With the long groove facing forward and the scarf facing back, slide the needle up and into the needle bar as far as it will go.

It is recommended that the eye of the needle be tilted 5° to the right; however a range of needle orientation is acceptable.



BERNINA



The eye of the needle can be facing directly forward or be tilted to the right by a maximum of 20°.

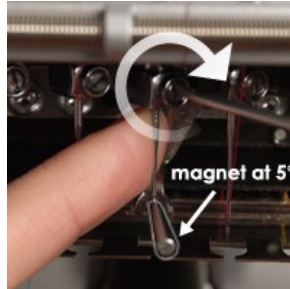

i *Important: Do not tilt the needle so that the needle eye is oriented to the left. This will result in poor sewing performance (e.g., thread breaks).*

i *Note: If the needle will not go into the needle bar without significant force, there may be a burr in the hole of the needle bar. If that is the case, replace the needle bar.*

Thread Clean Thread Path

Thread clean thread path is measured using a length of thread from the machine and a 100 gram weight.

1. Stroke the thread back and forth over the area to be checked for thread clean 50 times. If the thread breaks or begins to fray prior to the end of 50 strokes, then the area checked is not "thread clean." The affected part will require replacement.
2. Only the section of parts where thread will pass over or through is required to meet "thread clean" standards.

Z-Belt Tension

Z-belt tension is most accurately measured using a BRECO meter. Should a BRECO meter not be available the z-belt tension needs to be measured as described under Z-Drive Belt Tensioning in this manual.

The specification for z-belt tension is 72-78 Hz (or 6.8 ± 0.3 lbs with the force gauge). The machine must be set to the Z head-up position and the z-belt tension measurement has to be taken at the midpoint between the motor pulley and upper z-pulley when using the gauge.

BERNINA

Should the belt tension be out of the specified range it needs to be re-tensioned. Use the guidelines outlined in Z-Drive Belt Tensioning.

X-Cable Tension

X-cable tension is most accurately measured using a BRECO meter. Should a BRECO meter not be available, the X-cable tension needs to be measured as described under X-Cable Tensioning in this manual.

The specification for x-cable tension is $145 \pm 5\text{Hz}$ (or 10.5 ± 0.5 lbs with the force gauge). The x-beam must be $350\text{mm} / 13.8''$ from the center of the X-cable pulley when using the gauge.

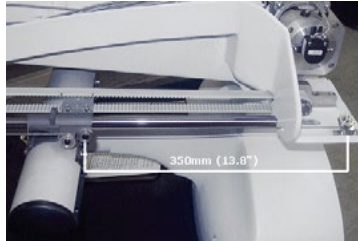

Should the cable tension be out of the specified range it needs to be re-tensioned. Use the guidelines outlined in X-Cable Tensioning.

Y-Axis Timing Belt Tension

Y-axis timing belt tension is most accurately measured using a BRECO meter. Should a BRECO meter not be available, the Y-axis timing belt tension needs to be measured as described under Y-Axis Timing Belt Tensioning in this manual.

The specification for Y-axis timing belt tension is $45\text{-}50\text{ Hz}$ (or 8.1 ± 0.3 lbs with the force gauge). The x-beam must be pushed all the way to the front of the machine when using the gauge. The measurement should be taken at the center of the Y-belt.

Should the belt tension be out of the specified range it needs to be re-tensioned. Use the guidelines outlined in Y-Axis Timing Belt Tensioning.

Proper Lubrication of Moving Parts

Check all moving parts for proper lubrication. Proper lubrication is absolutely essential for the quality operation and longevity of the moving parts on the machine. Scheduled lubrication as specified in this manual is the minimum lubrication schedules that must be followed to maintain the machine in optimum operating shape.

At a minimum, the rotary hook should be lubricated after each operation.

Other parts should be lubricated on schedule as specified in this manual. Failure to maintain proper lubrication of the machine will result in premature failure of moving parts, especially with regards to the rotary hook.



IMPORTANT: Make sure that the felt pads at the top and bottom of the needle case 4-packs are soaked with oil to ensure proper lubrication of the needle bars.
